

ASSEMBLY INSTRUCTION  
 \*\*\*DO NOT TIGHTEN SCREWS UNTIL COMPLETELY ASSEMBLED\*\*\*

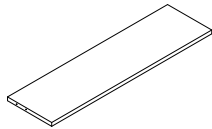

A×1PC

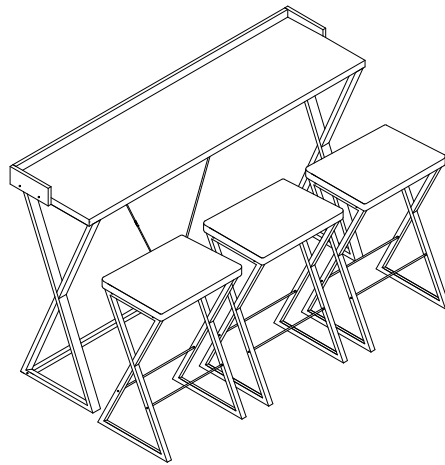

B×2PCS



C×6PCS

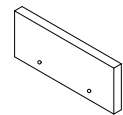

D×2PCS

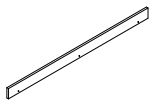

E×1PC



F×2PCS

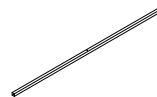

G×1PC



H×12PCS

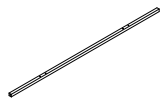

I×2PCS



J×3PCS



M6×30mm

K×42PCS



M7×40mm

L×7PCS

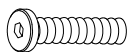

M6×50mm

M×6PCS



M6×12mm

N×3PCS



O×4PCS



Q×1PC

1

Steps 1 to 3 are the installation instructions of table.

B×2  
F×2  
G×1  
M×6  
N×3  
O×4  
I×2

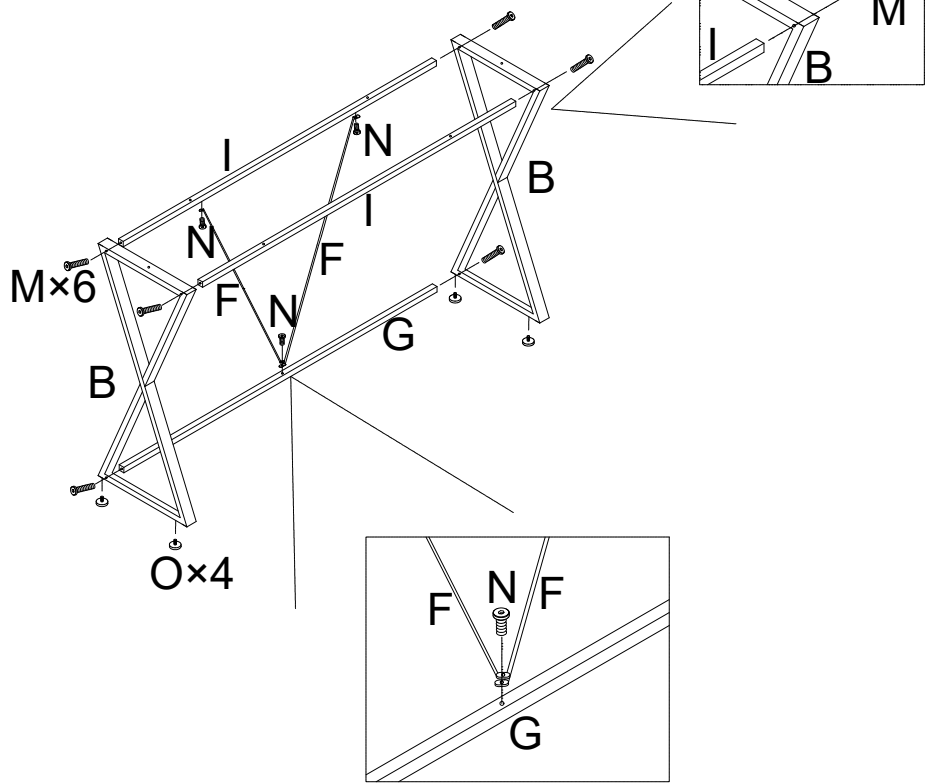

2

connect panel D to panel A with screw L  
connect panel E to panel A with screw L

A×1  
D×2  
E×1  
L×7

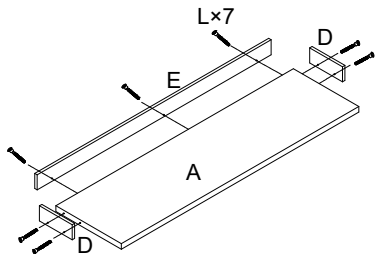

3

connect panel A to finished metal underframe of step 1 through screw K

A×1  
K×6

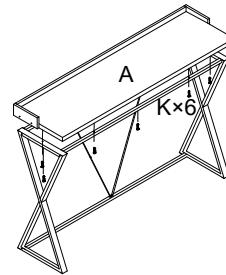

4

Steps 4 to 5 are the installation instructions of chairs.  
connect hardware C and hardware H together with screw.

C×2  
H×4  
K×8

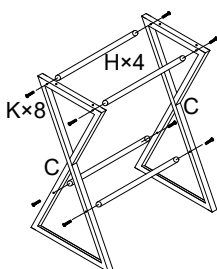

×3

5

connect panel J to finished metal underframe of step 4 through screw K.

J×1  
K×4

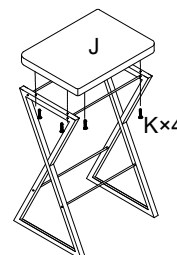

×3