

60" Alum slat table in Hex shape

Assembly Instructions

READ AND SAVE THESE INSTRUCTIONS

Step 1: Remove all protective materials and check all component pieces against parts list.

Step 2: Place the table top (A) upside down on a flat surface to start assembly.

Step3: Attached Table Legs (B)to Table top (A) using Bolt(D)through washer(F) ,as shown in Photo 1. **Important :DO NOT TIGHTEN BOLTS AT THIS POINT**

Step4: Align the bolt holes in the leg connector ring (C) with those on the Table legs (B). From the inside of the leg connector ring (C), loosely attach (B) to the (C) using bolts (E) through washers (F) in Photo 2.

Step 5: Tighten all of bolts and Cover all bolts (D& E) with bolt covers (G)

With the help of another person, carefully turn the table to the upright position. The table is ready for your enjoyment.

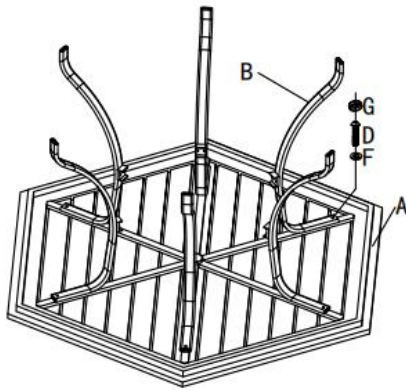

Photo 1

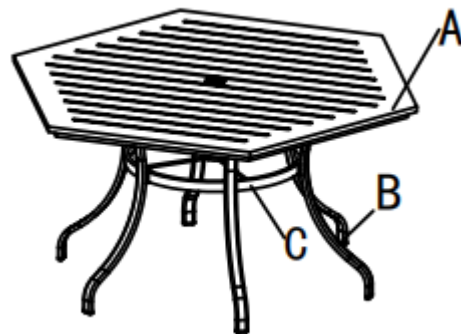

Photo 3

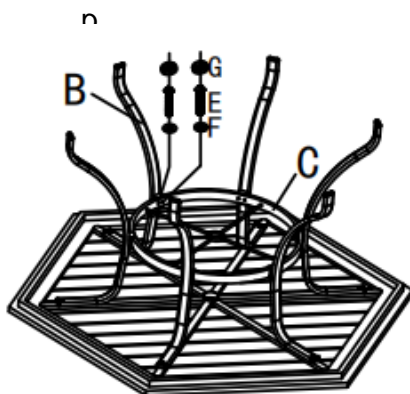
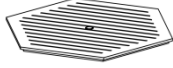





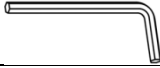



photo 2

PARTS LIST

A	TABLE TOP		1
B	TABLE LEG		6
C	Leg Connector Ring		1
D	1/4" X 25mm Bolt		6
E	1/4" X 30mm Bolt		12
F	1/4" Flat washer		18
G	1/4" Bolt cover		18
H	Hex screw driver		1
I	PARASOL CAP		1