

HONBAY

HONBAY

English / Español

LZ229

Transform Living

E-mail: Support@honbayus.com

REV.1

Assembly Instructions

U Shaped Sectional Sofa

AVISO:

Conserve estas instrucciones para futuras consultas.

- ◆ Lea las hojas de instrucciones completamente antes del montaje. Retire todas las piezas de la caja y asegúrese de que todos los componentes estén incluidos antes del montaje.
- ◆ Ensamble el sofá sobre una superficie protegida para evitar rayar los componentes del sofá.
- ◆ Tenga cuidado de no enroscar los tornillos.
- ◆ Puede usar un martillo de madera para ayudar a ensamblar y asegurarse de que las uniones y los tubos estén ensamblados en su posición.
- ◆ ¡Se recomiendan dos personas para el montaje!
- ◆ Cuando ensamble su sofá, si huele un olor extraño a material, no se preocupe, es muy normal. Lo que debería hacer es ponerlo durante 1 o 2 días en el balcón, patio o cerca de la ventana para que se ventile y se esfume el olor. Honbay Sofá ha sido certificado por la autoridad ambiental. Así que no se preocupe, es completamente seguro y no dañará su salud.

INSTRUCCIONES DE DEVOLUCIÓN/RECLAMACIÓN POR DAÑOS:

- ◆ Este artículo se envía en varias cajas separadas. Si solo recibe una caja, espere pacientemente el resto de cajas. Si no ha recibido el resto de cajas en un plazo de dos días hábiles, por favor comuníquese con nosotros de inmediato. Nuestra dirección de correo electrónico es Support@honbay-us.com.
- ◆ Si el paquete está dañado, por favor comuníquese con nosotros lo antes posible y adjunte la foto dañada.
- ◆ Política de devolución: Este artículo se puede devolver en un plazo de 30 días sin ningún motivo. Si devuelve este artículo por motivos personales, debe asumir el costo del transporte de las devoluciones y el de procesamiento del pedido (tarifa de reposición del 0-50% según el precio de la factura). Si el producto tiene problemas de calidad (no causados por humanos), nos haremos cargo del envío.
- ◆ Si necesita devolver la mercancía, conserve la caja original. Por favor, asegúrese de utilizar la etiqueta de devolución proporcionada por nosotros y no devuelva la mercancía sin permiso. No comparta una etiqueta con varias cajas.
- ◆ Si devuelve el producto después de 30 días de haberlo recibido, tememos que no se acepte su solicitud de devolución. Por eso agradecemos su comprensión.
- ◆ La garantía del producto es de un año. Si este artículo se daña dentro del periodo de garantía, le proporcionaremos las piezas de repuesto gratuitamente. Si el artículo se daña por alguna razón personal, también podemos reemplazarlo por usted, sin embargo, debe asumir el costo del transporte.

NOTICE:

- ◆ Please retain these instructions for future reference.
- ◆ Please read the instruction sheets completely before assembly. Remove all parts from the carton and ensure all components are included before assembly.
- ◆ Assemble the sofa on a protected surface to avoid scratching the components of the sofa . Be careful not to cross-thread screws.
- ◆ You can use a wooden hammer to help assemble to make sure the joints and tubes are assembled in position.
- ◆ Two people are recommended for assembly!
- ◆ When you assemble your sofa , if you smell a weird smell of the material, please don't worry it's very Normal. What you should do is to air it for 1or 2 days on your balcony, patio, or near your window. Honbay Sofas have been certified by the environment authority. So please don't worry it won't hurt your health, it's the environment authority. So please don't worry it won't hurt your health, it's completely safe.

RETURN/DAMAGE CLAIM INSTRUCTIONS:

- ◆ This item is shipped in multiple separate boxes. If you only receive one box, please wait patiently for the rest of boxes. If you have not received the rest of boxes within wait patiently for the rest of boxes. If you have not received the rest of boxes within two working days, please contact us immediately. Our email address is Support@honbayus.com.
- ◆ If the package is damaged, please contact us as soon as possible and attach the damaged photo. Return Policy: This item can be returned within 30 days without any reason. If you return this item for personal reasons, you need to bear the freight of returns and order processing fee (0-50% restocking fee based on the invoice price). If the product has quality issues (not caused by humans), we will bear the freight.
- ◆ If you need to return the goods, please keep the original box. Please make sure to use the return label provided by us and do not return it without permission. Please do not share a label with multiple boxes.
- ◆ If you return the product after 30 days from receiving it, we are afraid that your return application won't be accepted. We appreciate your understanding.
- ◆ The warranty product is one year. If this item is damaged within the warranty period we will arrange you the replacement parts free of charge.If the item is damaged for some personal reasons, we could also replace it for you, however you need to bear the transport fees.

Contents page / Página del catálogo

Please refer to the installation steps for the cartons included in your combination.

Consulte los pasos de instalación de los cartones incluidos en la combinación.

Part List Carton A	4
Part List Carton B	6
Part List Carton C	8
Part List Carton D	10
Combination Step Carton A+C	12
Combination Step Carton B+C+D	37

Part List / Lista de piezas

Carton (Cartón) A

A x 1

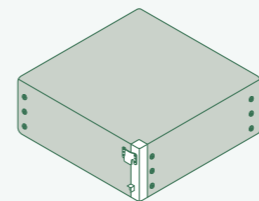

Corner Seat Frame
Marco de asiento de esquina

B x 1

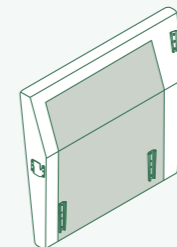

Corner Back Frame (Big)
Marco trasero de esquina (grande)

C x 1

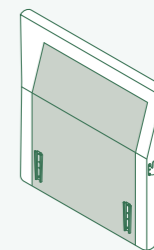

Corner Back Frame (Small)
Marco trasero de esquina (pequeño)

D x 1

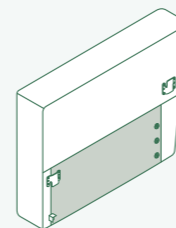

Left Armrest
Reposabrazos izquierdo

E x 1

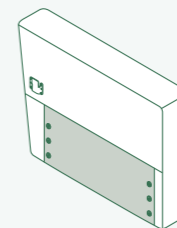

Right Armrest
Reposabrazos derecho

F x 1

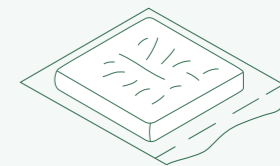

Corner Seat Cushion
Cojín de esquina

G x 1

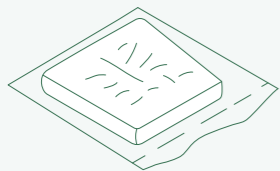

Corner Back Cushion (Left)
Cojín trasero de esquina (izquierda)

H x 1

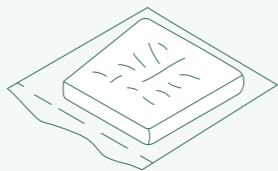

Corner Back Cushion (Right)
Cojín trasero de esquina (derecha)

I x 1

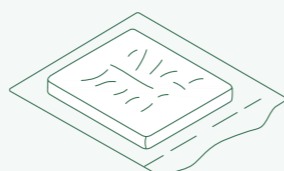

Single Seat Cushion
Cojín del asiento individual

K x 2

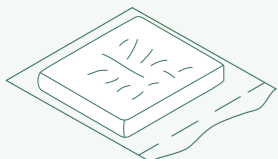

Single Back Cushions
Cojines de respaldo individual

1 x 8

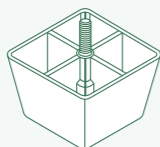

Legs
Piernas

2 x 8



Plastic Washers
Juntas

5 x 1

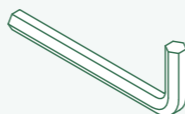

Wrench 5mm
Llave de tubo 5mm

Part List / Lista de piezas

Carton (Cartón) B

A x 1

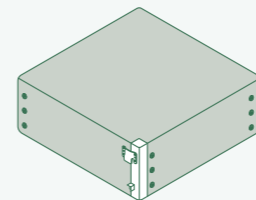

Corner Seat Frame
Marco de asiento de esquina

B x 1

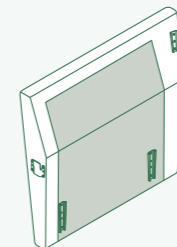

Corner Back Frame (Big)
Marco trasero de esquina (grande)

C x 1

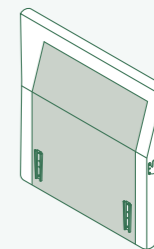

Corner Back Frame (Small)
Marco trasero de esquina (pequeño)

X x 1

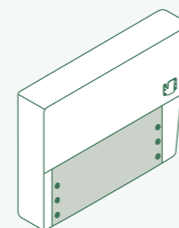

Left Armrest
Reposabrazos izquierdo

E x 1

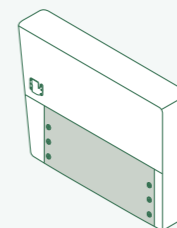

Right Armrest
Reposabrazos derecho

F x 1

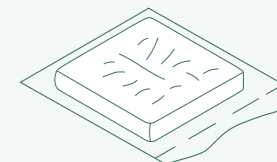

Corner Seat Cushion
Cojín de esquina

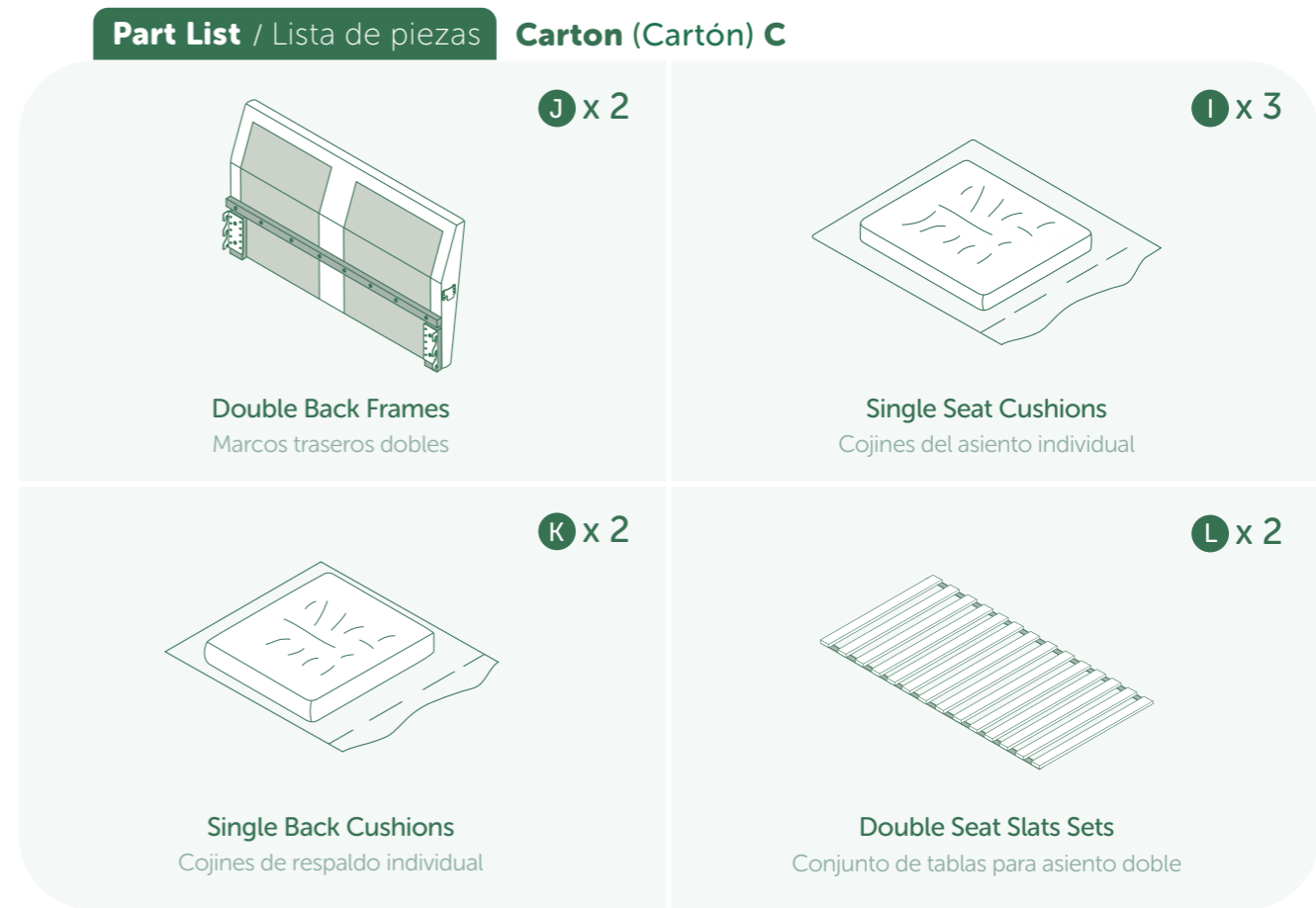
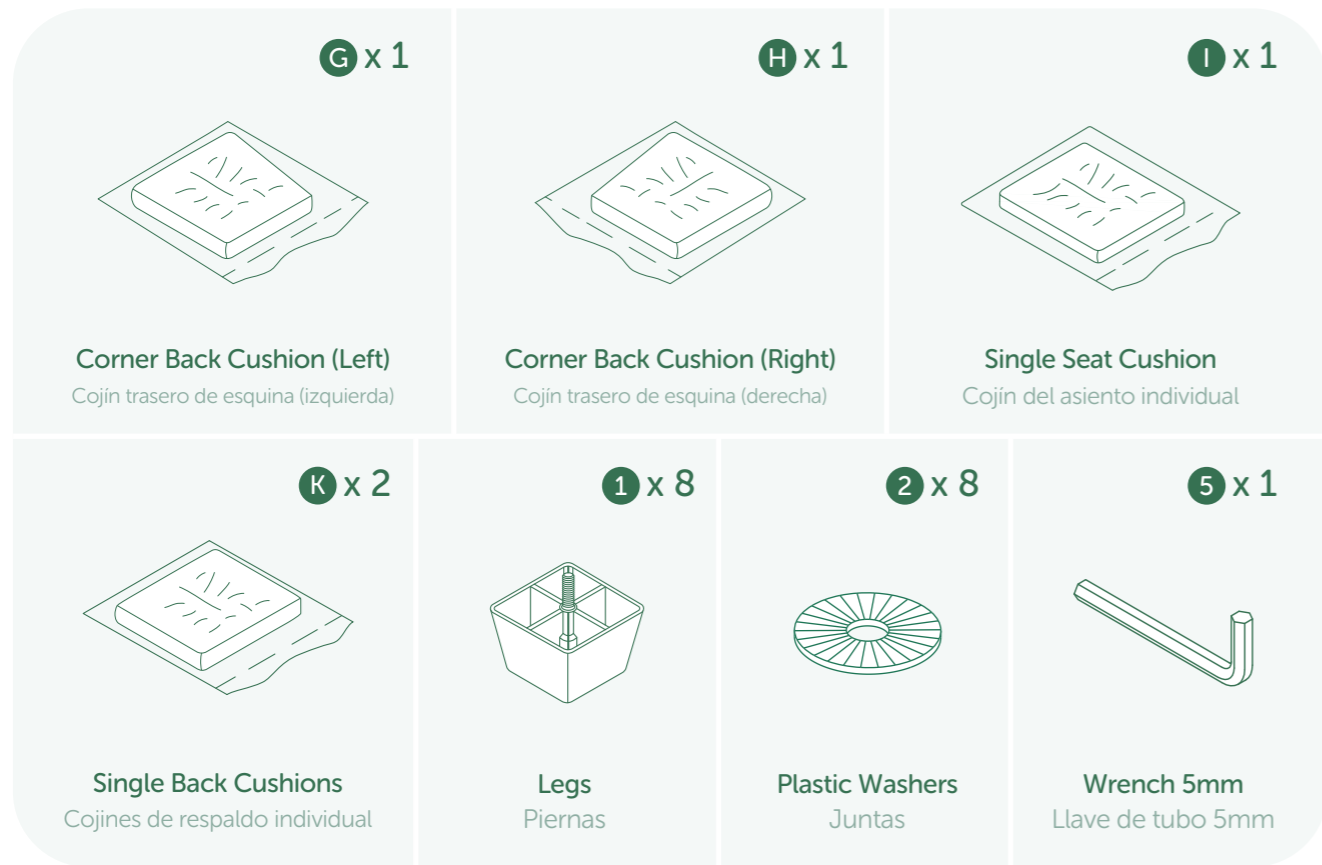

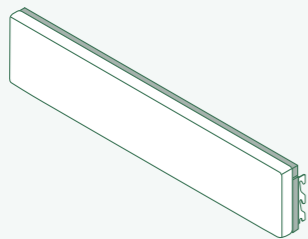

N x 1

Double Seat Front Apron

Delantal delantero con dos asientos

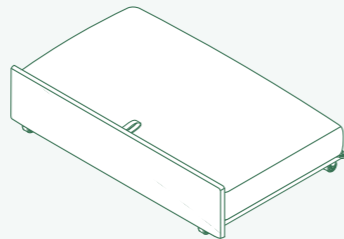

O x 1

Pull-Out Sofa Bed

Sofá cama plegable

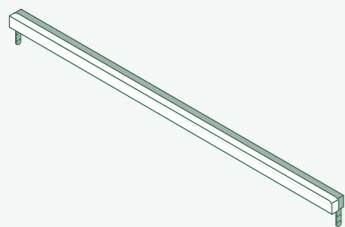

P x 1

Trundle Bed Latch

Trinquete de cama Trundle

Part List / Lista de piezas

Carton (Cartón) D

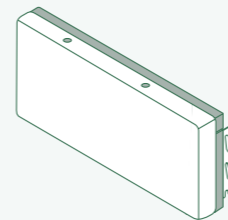

Q x 1

Single Seat Front Panel

Panel frontal de un solo asiento

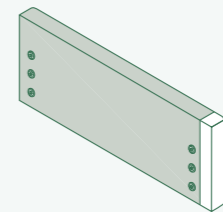

R x 1

Single Seat Side Panel

Panel lateral de un solo asiento

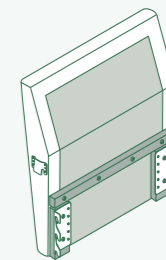

S x 1

Single Back Frame

Marco trasero individual

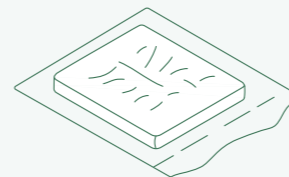

I x 1

Single Seat Cushion

Cojín del asiento individual

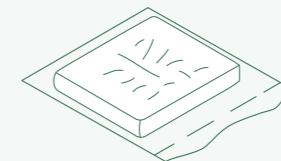

K x 1

Single Back Cushion

Cojín de respaldo individual

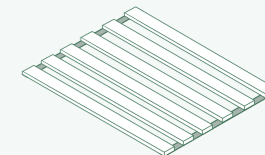

T x 1

Single Bed Slats Set

Juego de láminas para cama individual

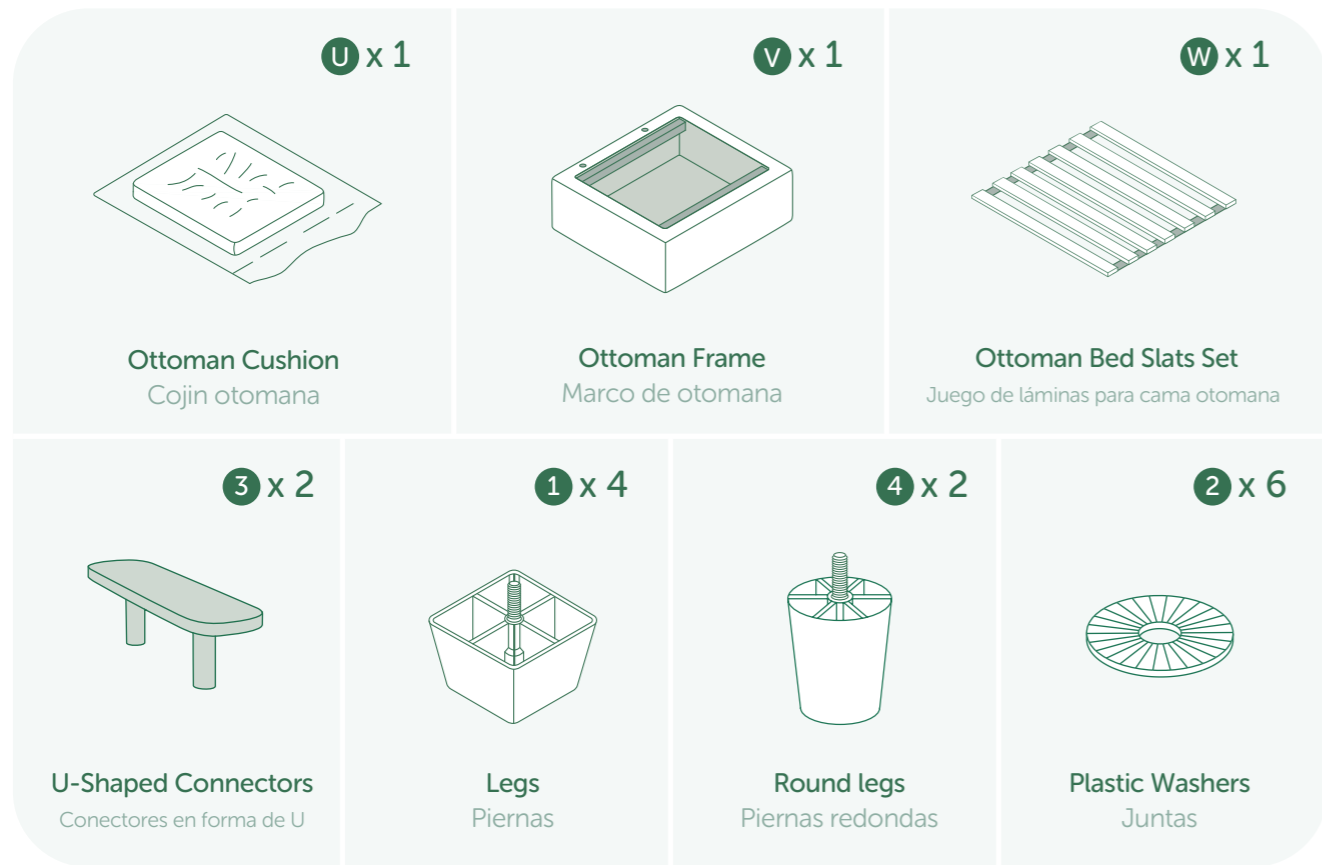

Combination Step / Paso de combinación

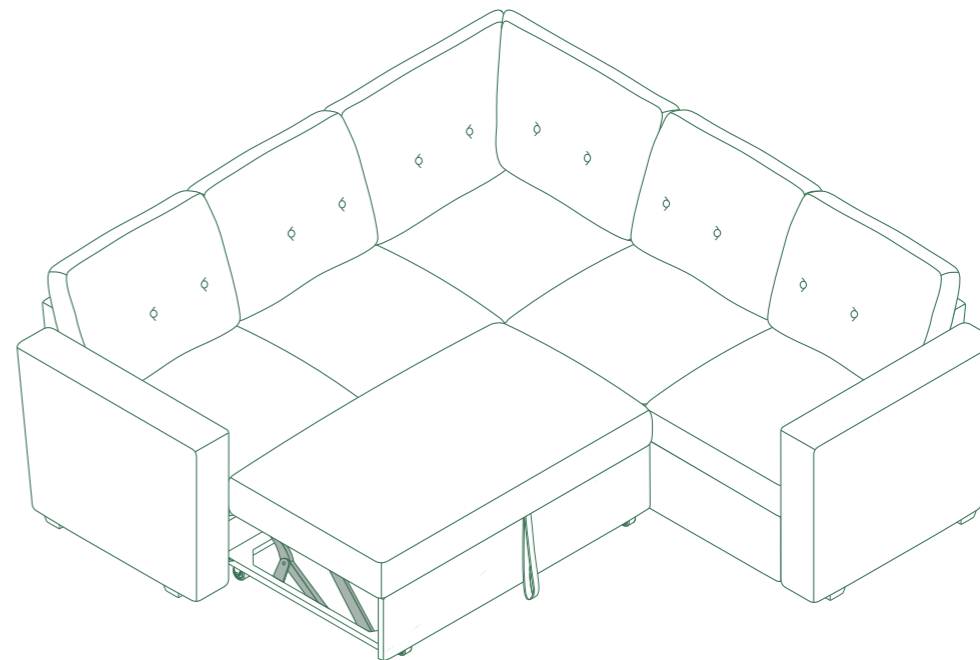

Carton A + C

Let's start...

♦ Don't tighten the screws one after another immediately until all screws are lined up with holes. Leave some space for adjustment.

No apriete los tornillos uno tras otro inmediatamente hasta que todos los tornillos estén alineados con los agujeros. Deje espacio para el ajuste.

♦ Remove all parts from the carton and place them on a protected surface or carpet.

Retire todas las piezas de la caja y colóquelas sobre una superficie o alfombra protegida.

1

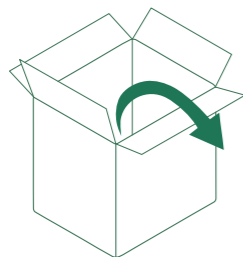

Carton A

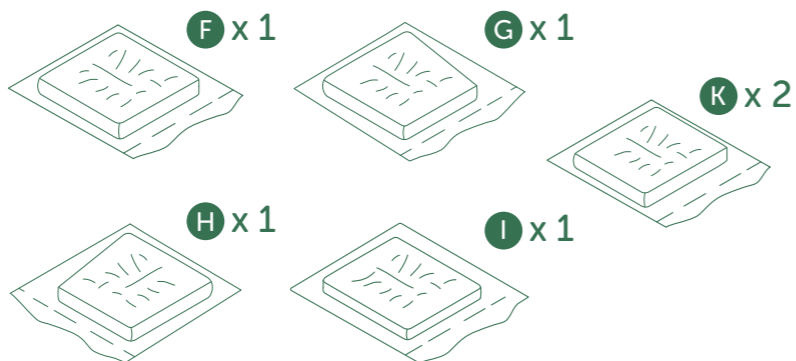

2

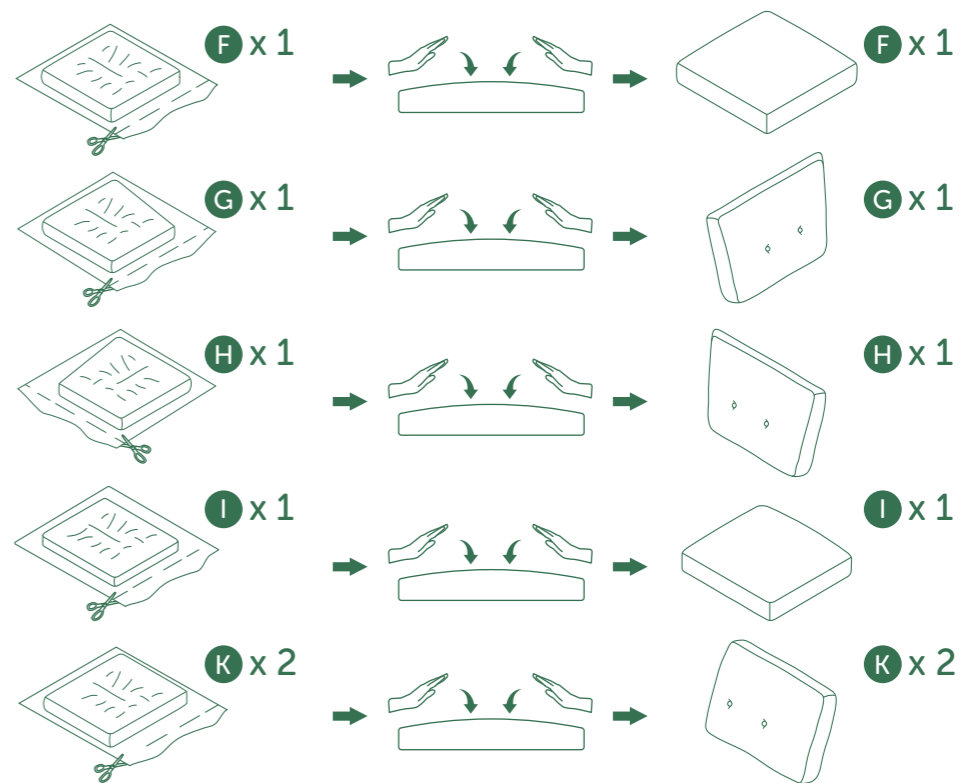

3

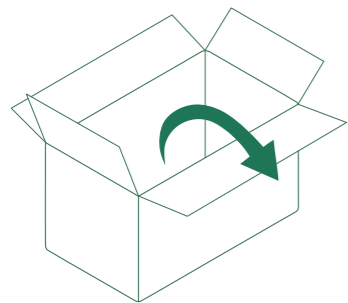

Carton C

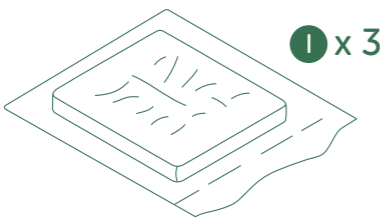

4

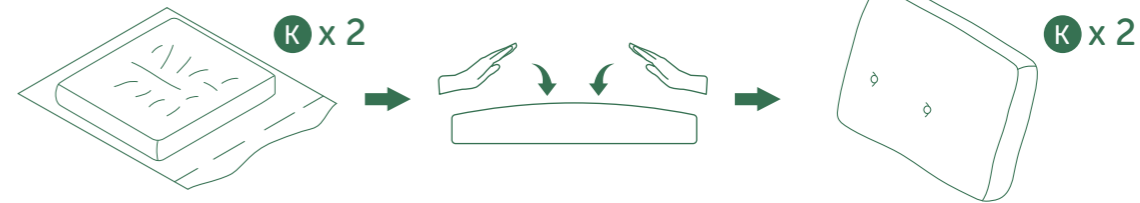
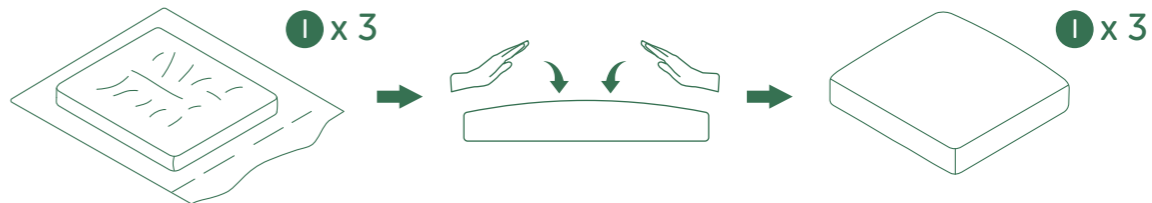

5

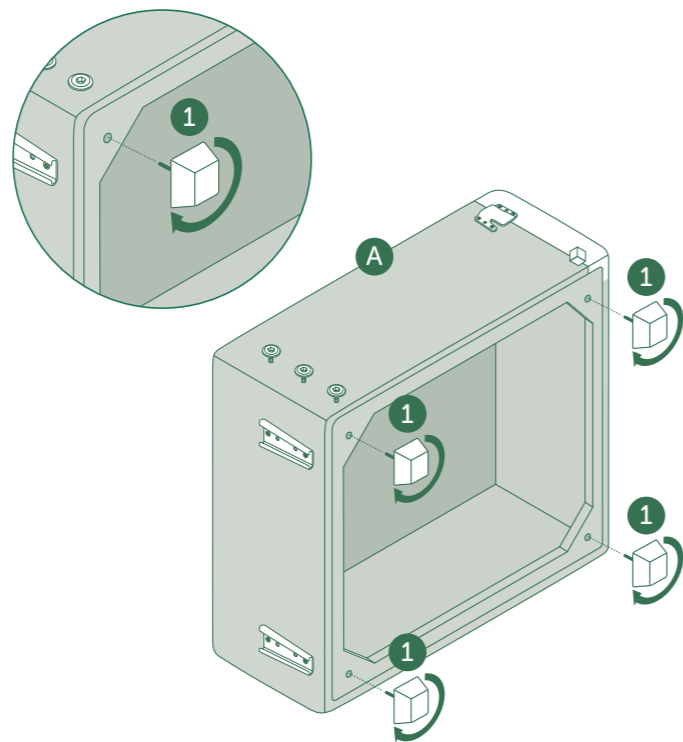
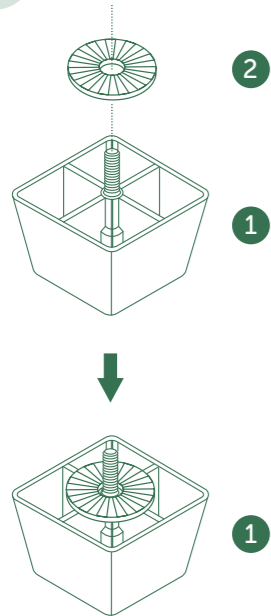

6

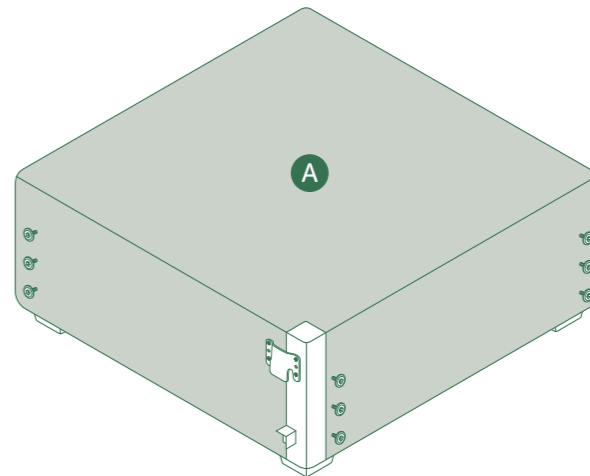

7

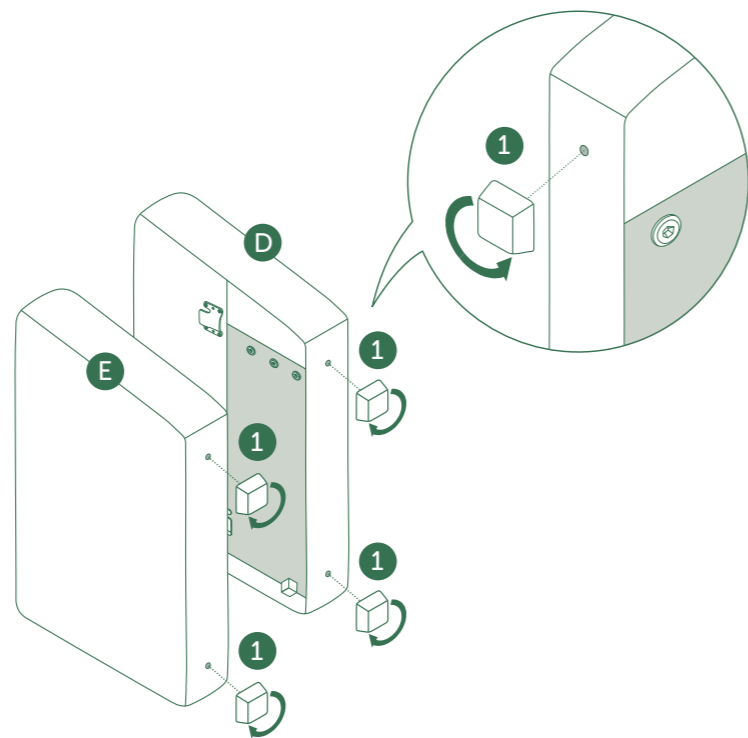
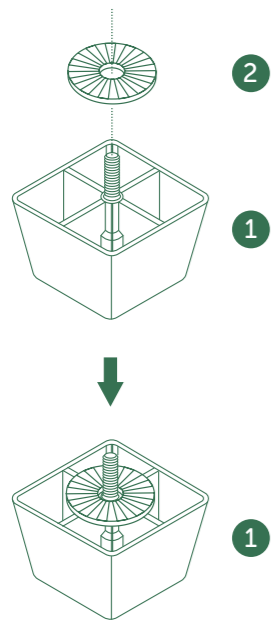

8

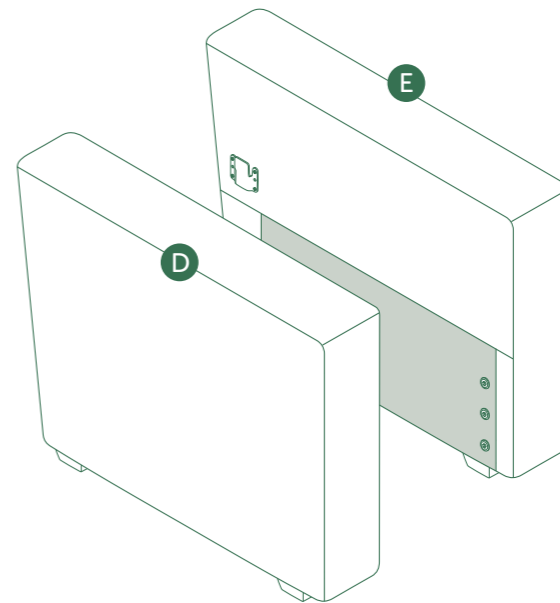

9

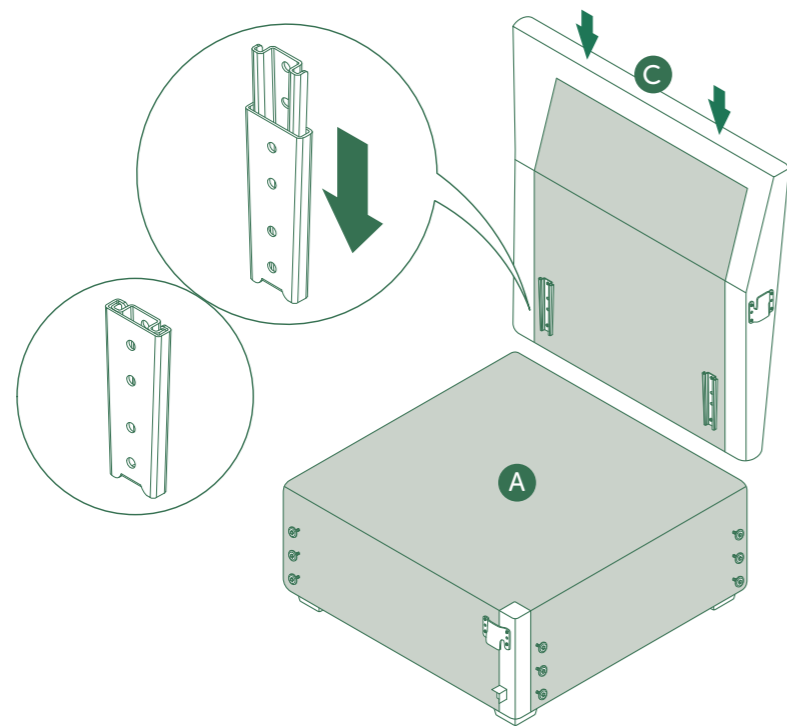

10

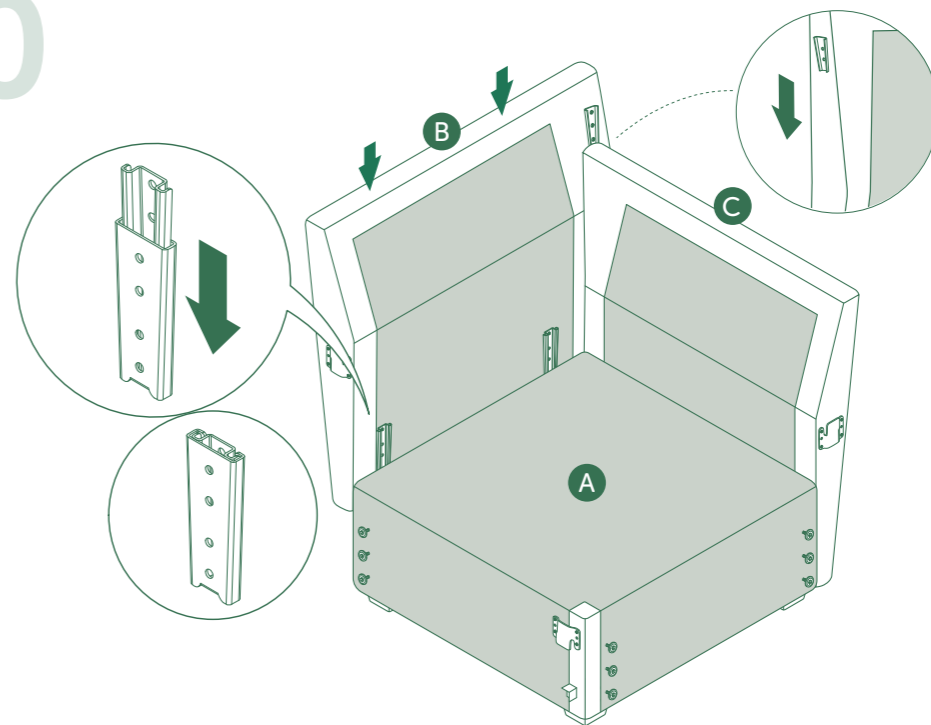

11

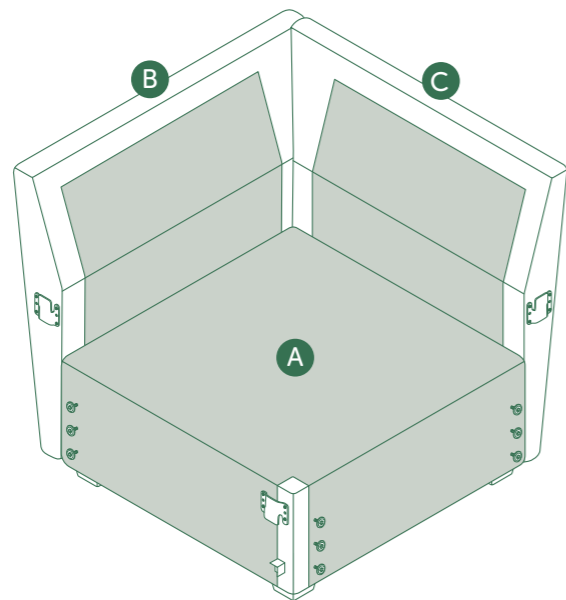

12

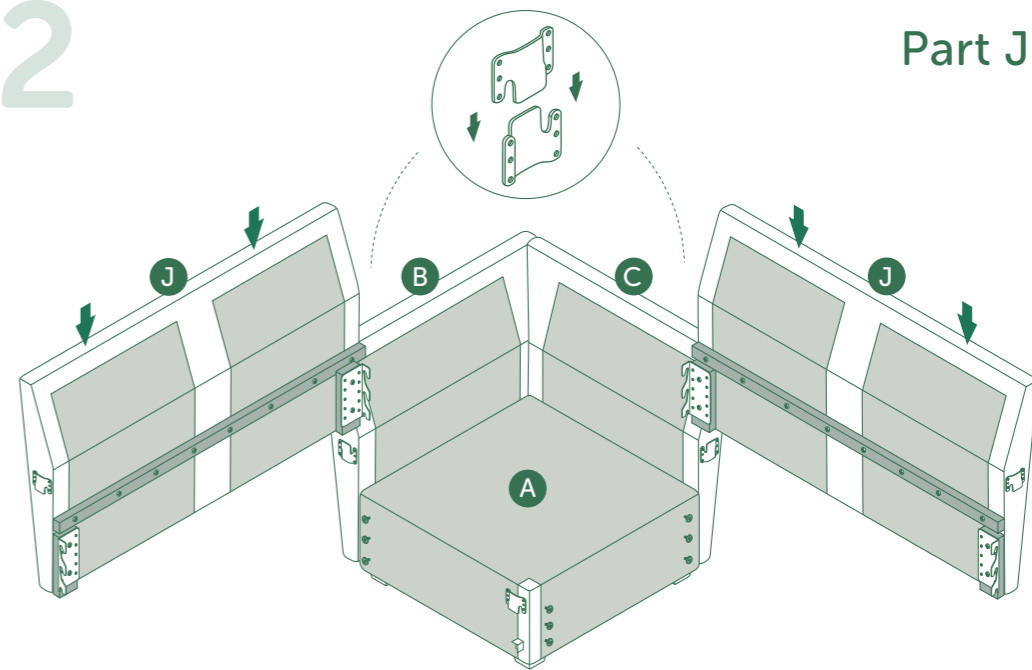

⚠ Install one side first and then the other.

13

Part D,E

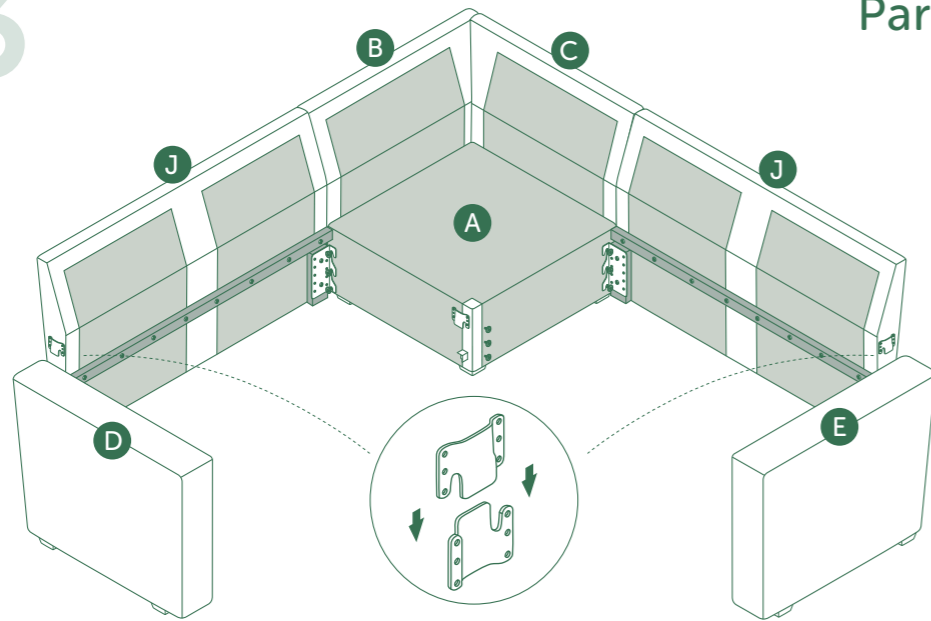

▲ Install one side first and then the other.

14

Part N

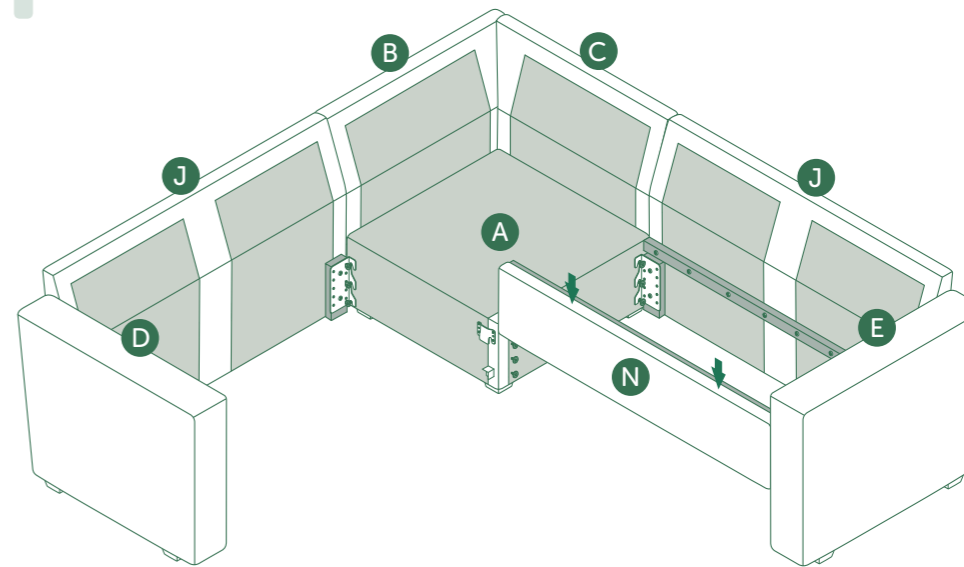

15

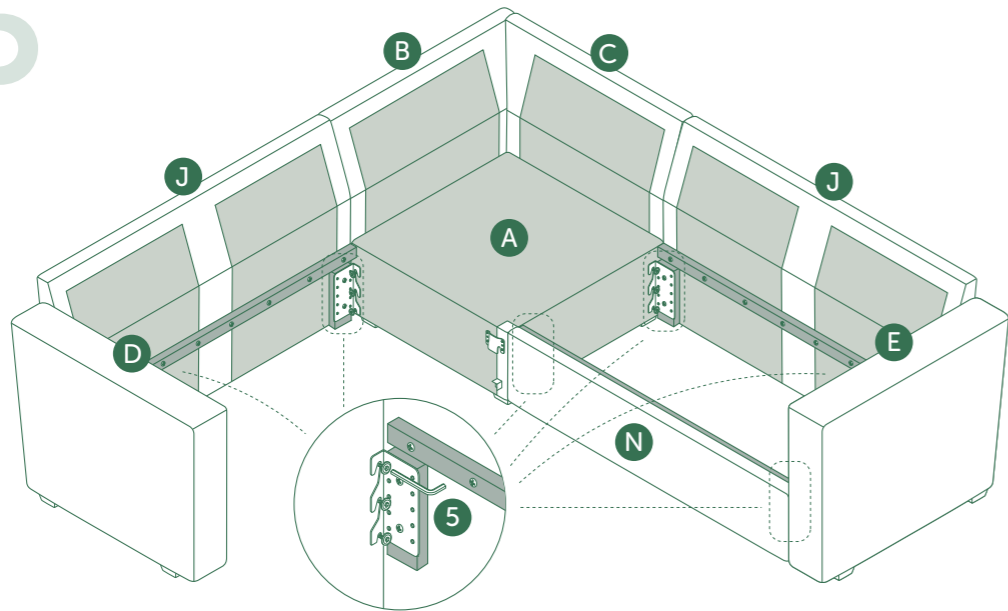

◆ Tips: Tighten the screw with a wrench

16

Part O

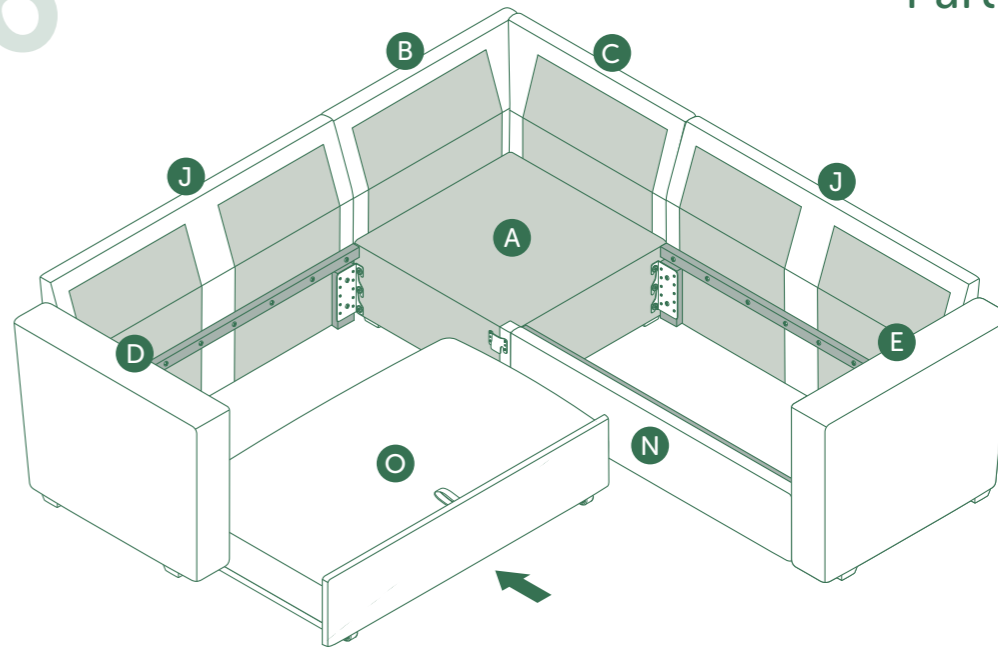

17

Part P

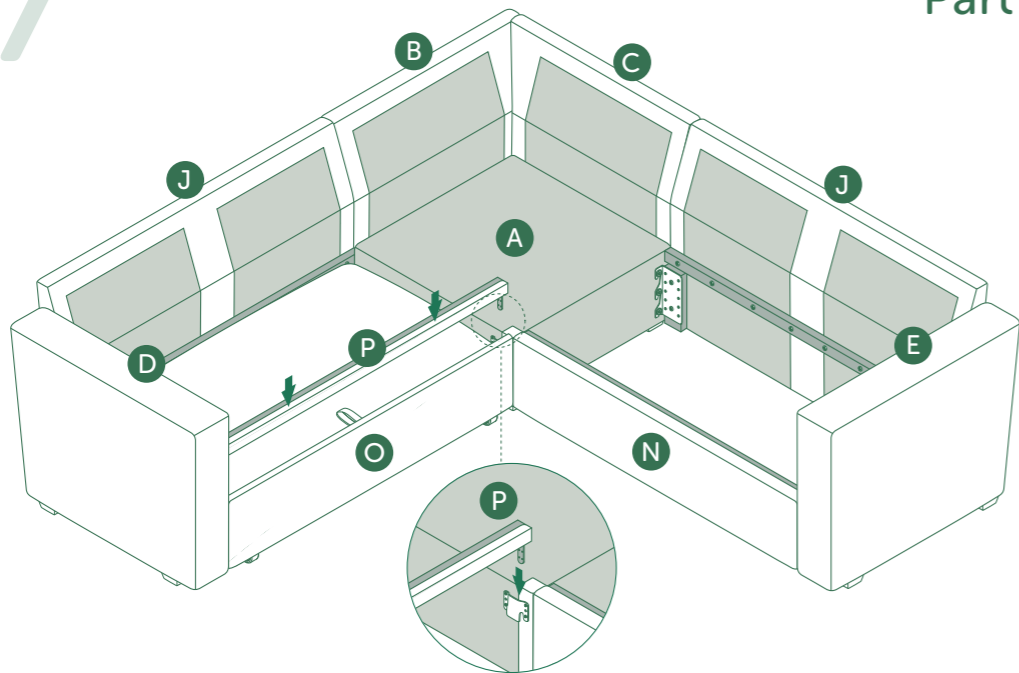

18

Part L*2

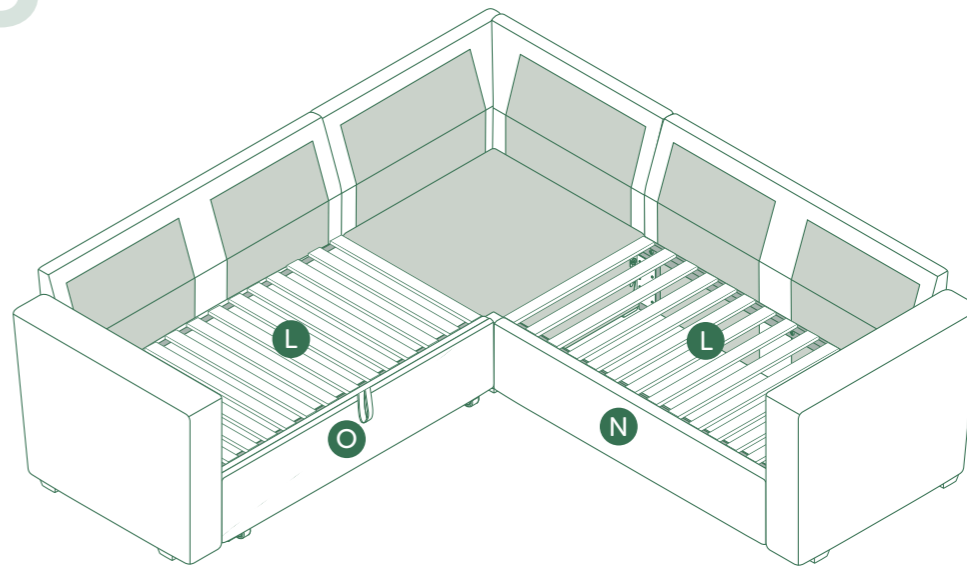

19

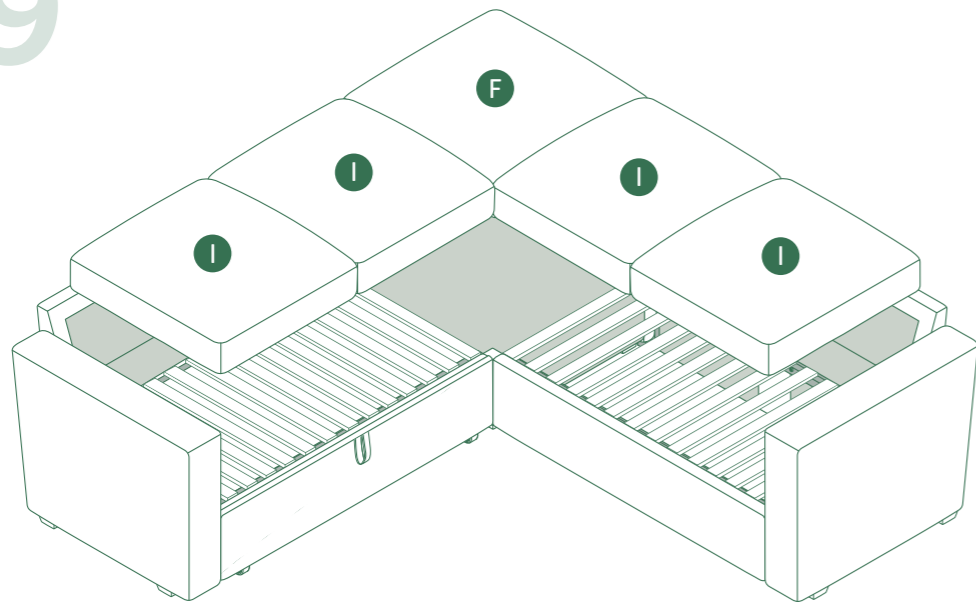

20

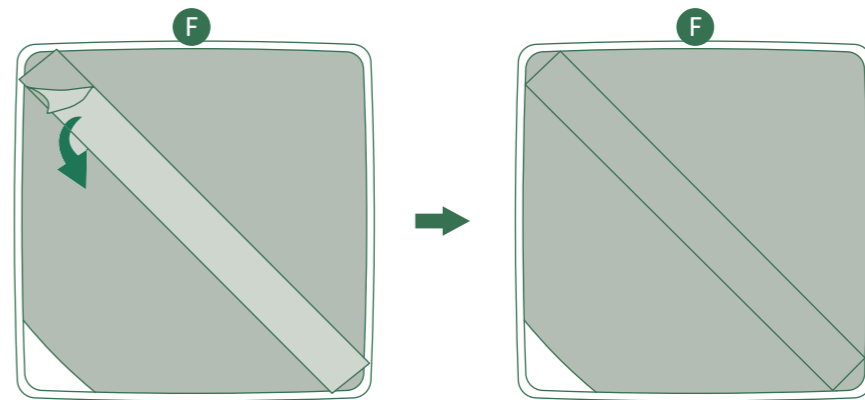

21

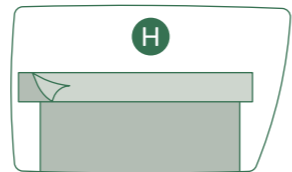
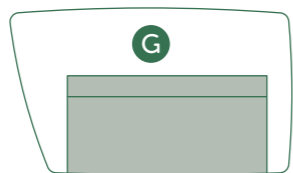
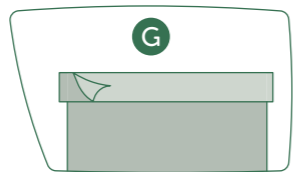
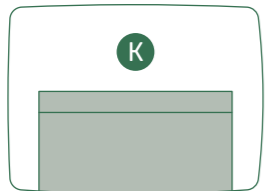
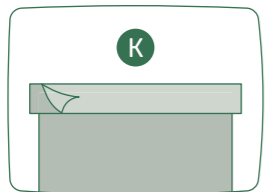

22

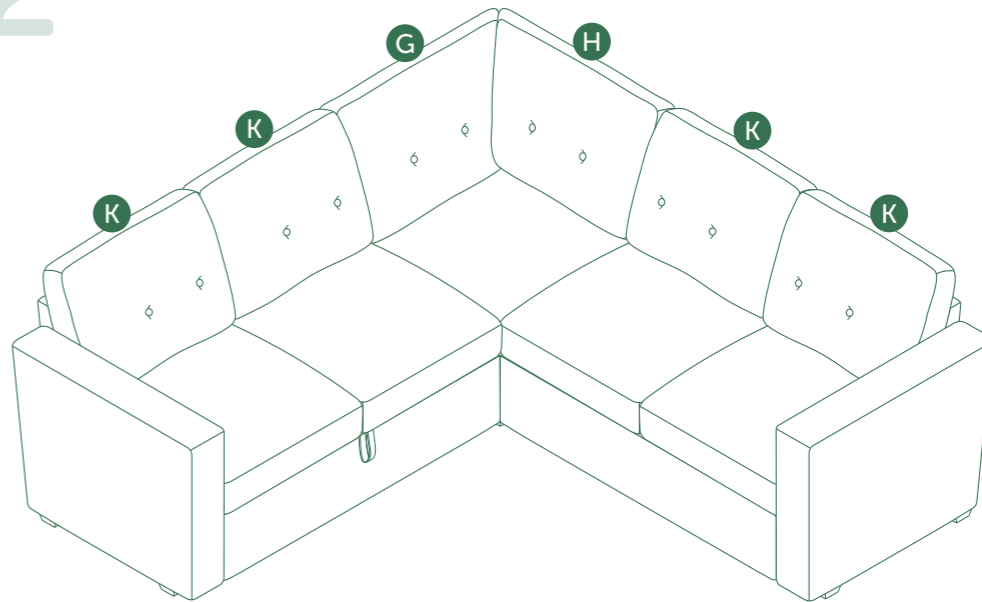

23

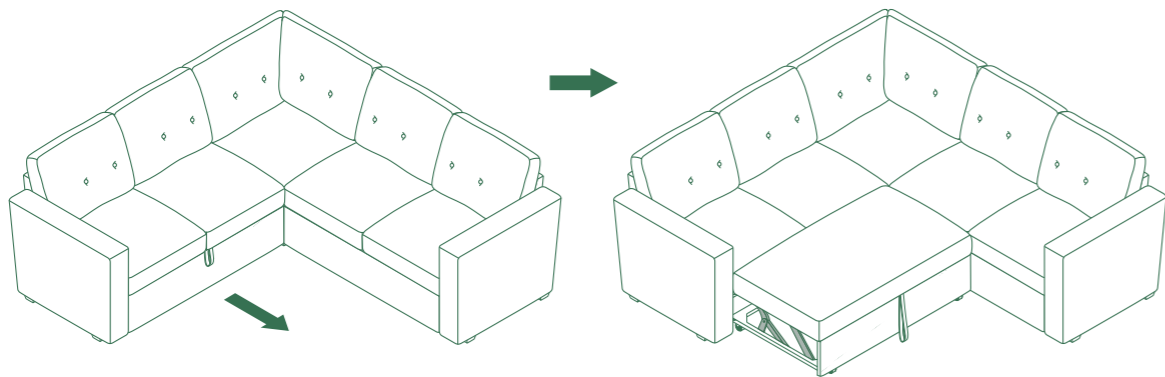

Finish / Terminar

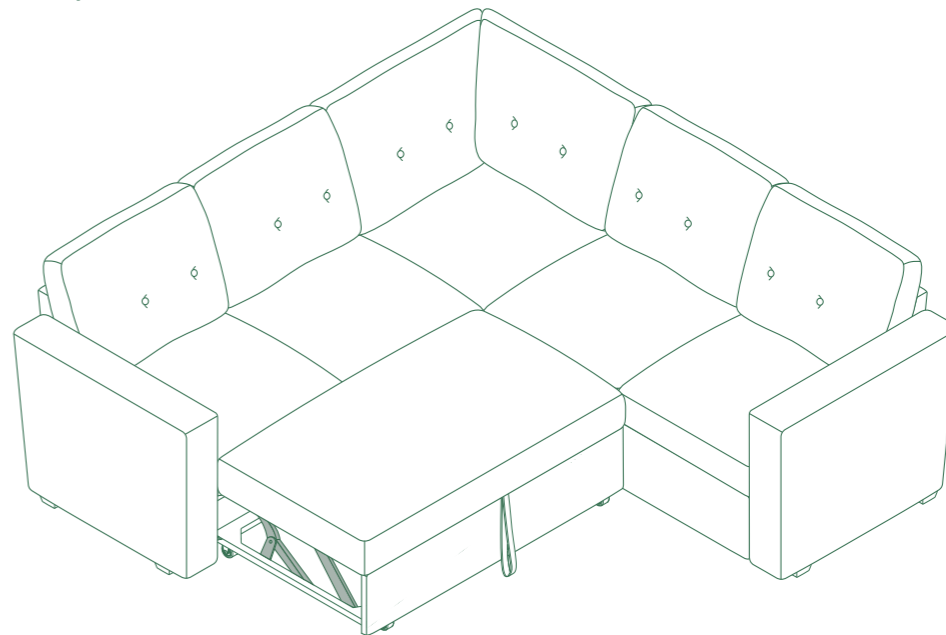

Combination Step / Paso de combinación

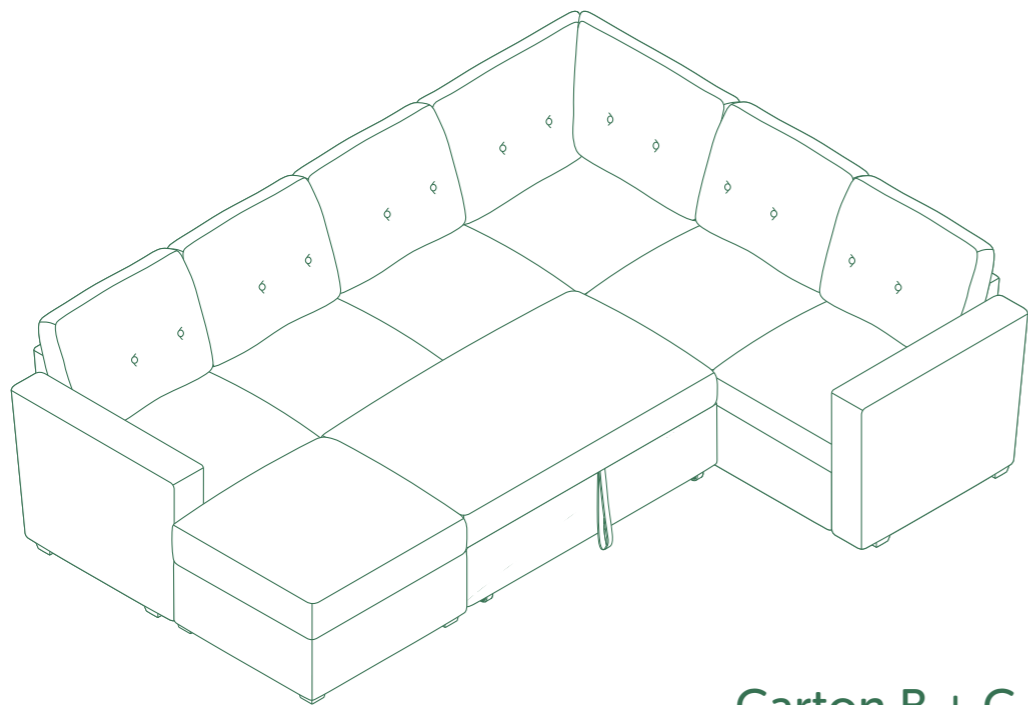

Carton B + C + D

Let's start...

- ◆ Don't tighten the screws one after another immediately until all screws are lined up with holes. Leave some space for adjustment.
No apriete los tornillos uno tras otro inmediatamente hasta que todos los tornillos estén alineados con los agujeros. Deje espacio para el ajuste.
- ◆ Remove all parts from the carton and place them on a protected surface or carpet.
Retire todas las piezas de la caja y colóquelas sobre una superficie o alfombra protegida.

1

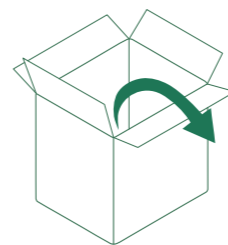

Carton B

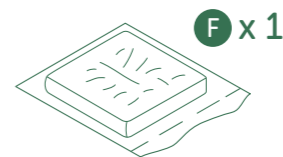

F x 1



G x 1

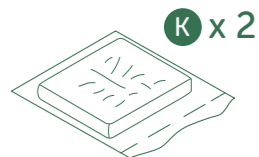

K x 2



H x 1

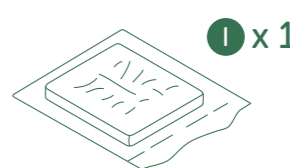

I x 1

2

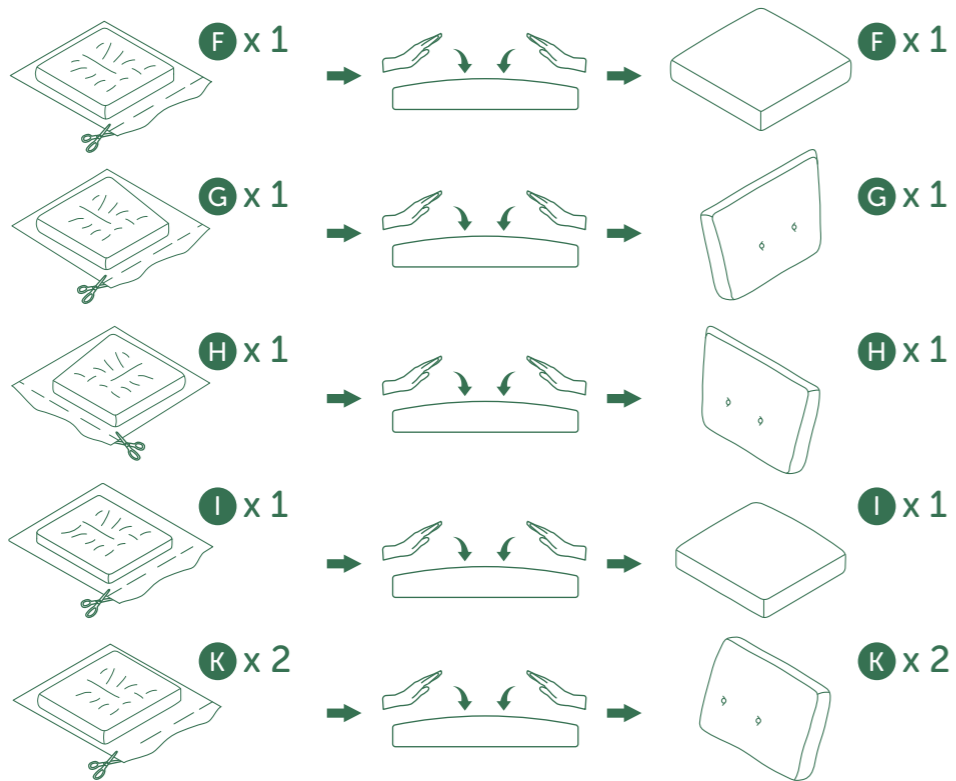

3

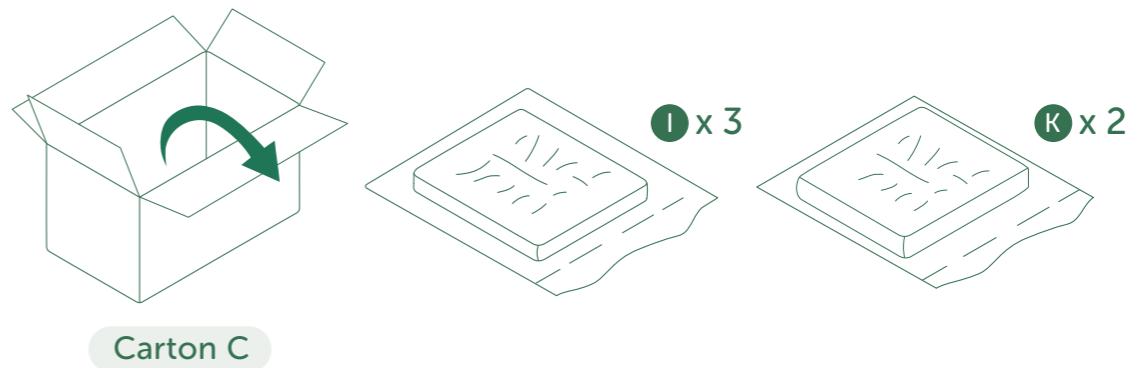

4

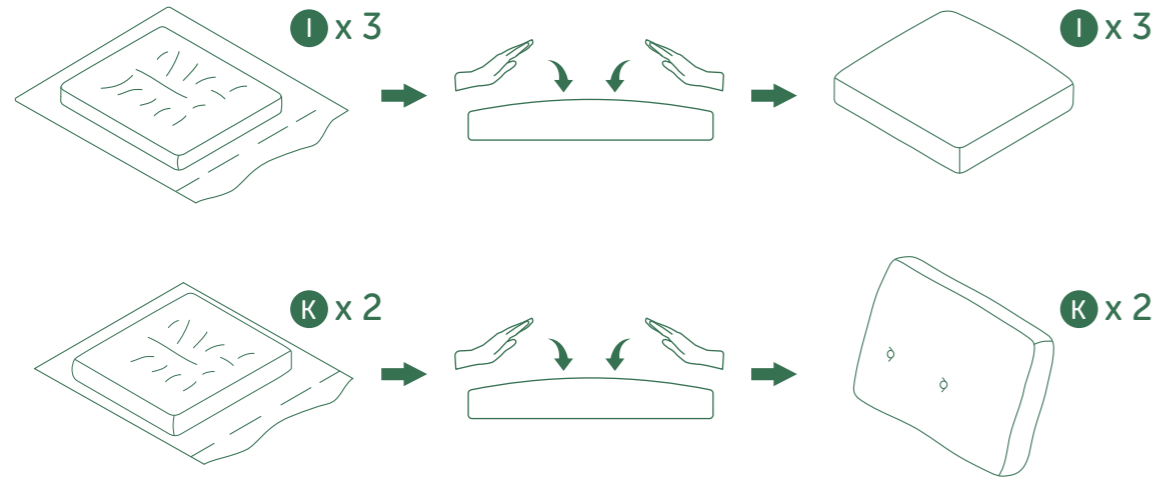

5

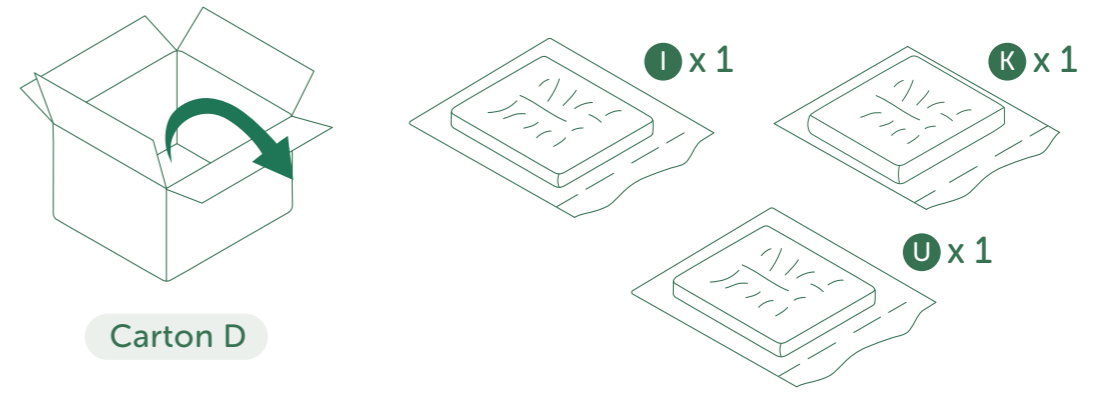

6

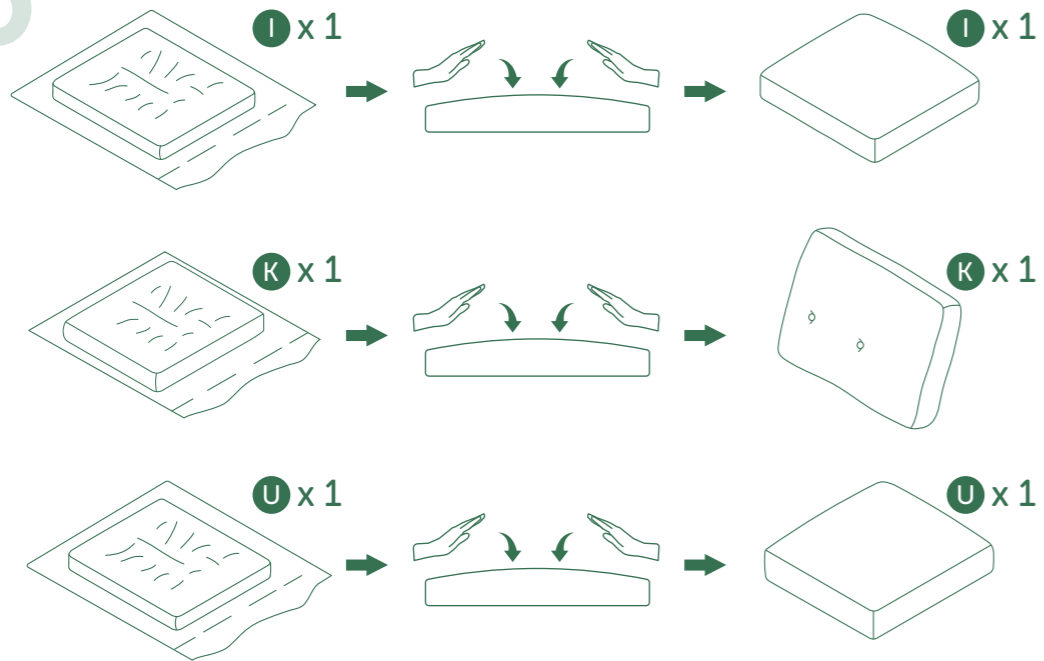

7

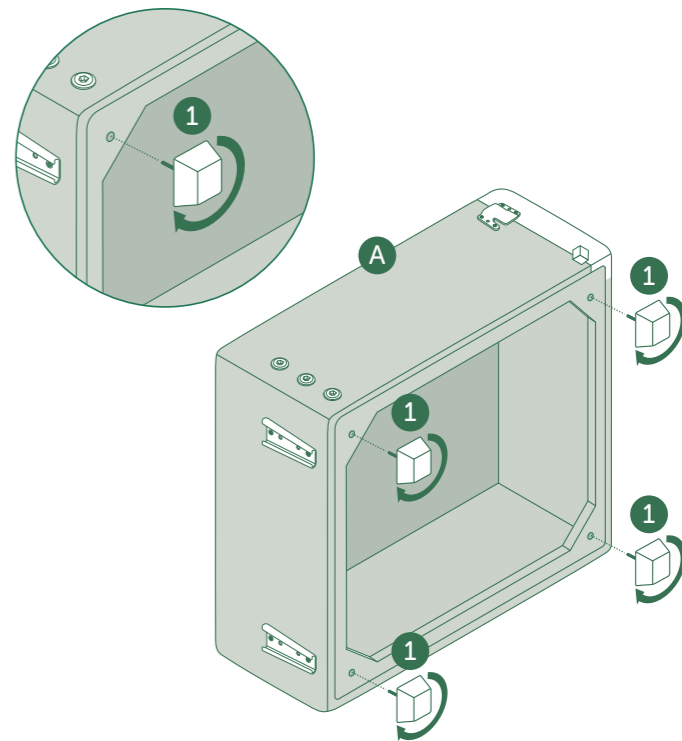
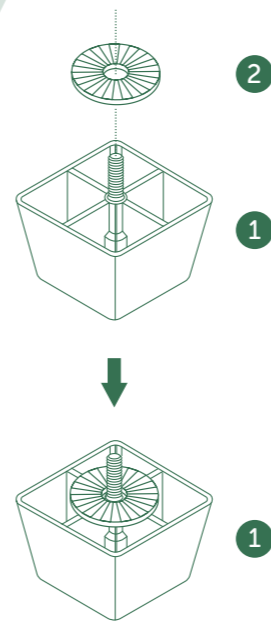

8

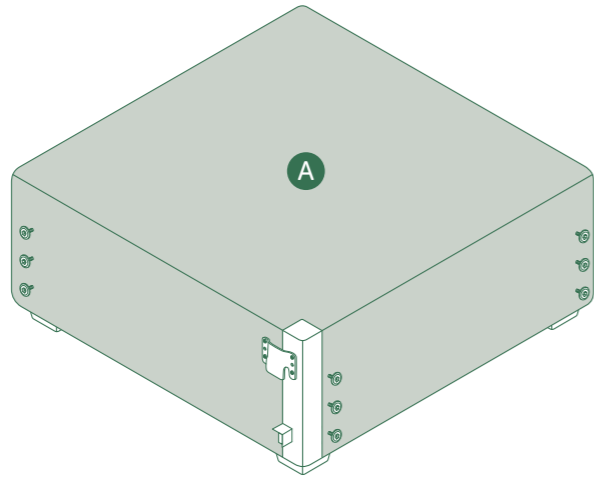

9

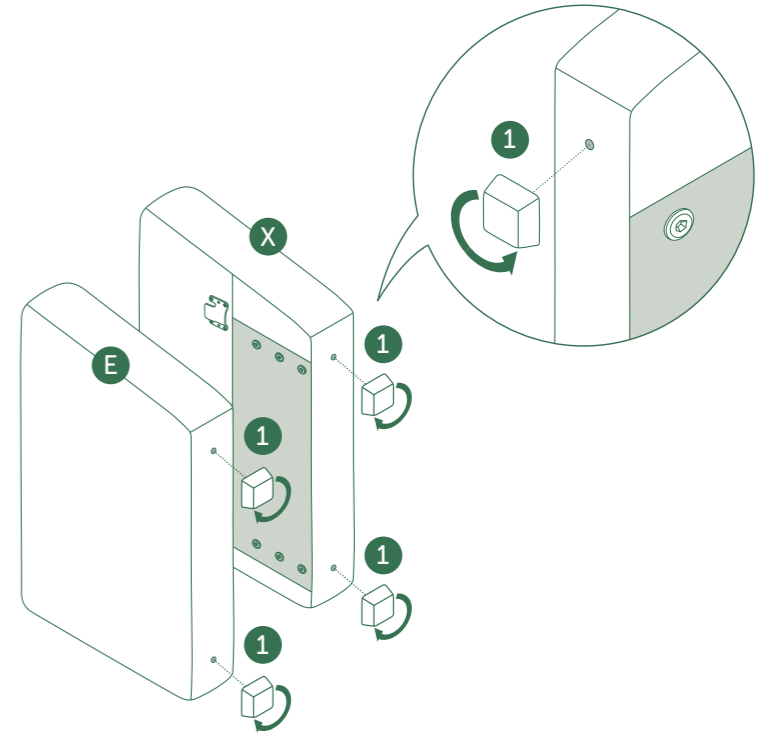
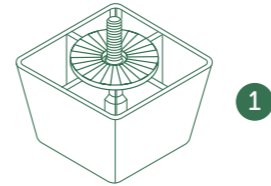
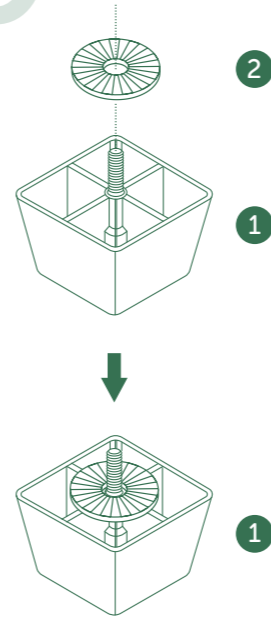

10

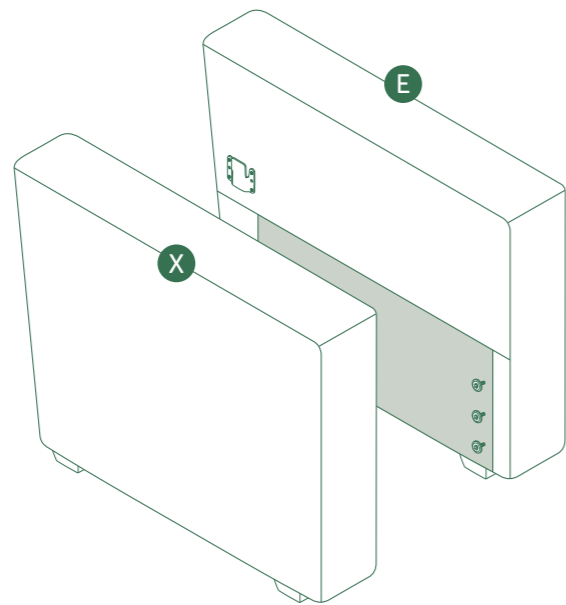

11

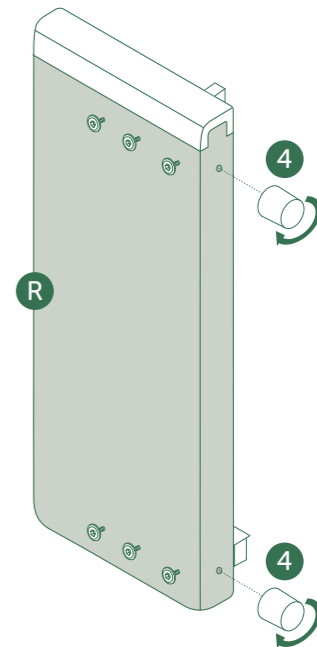

12

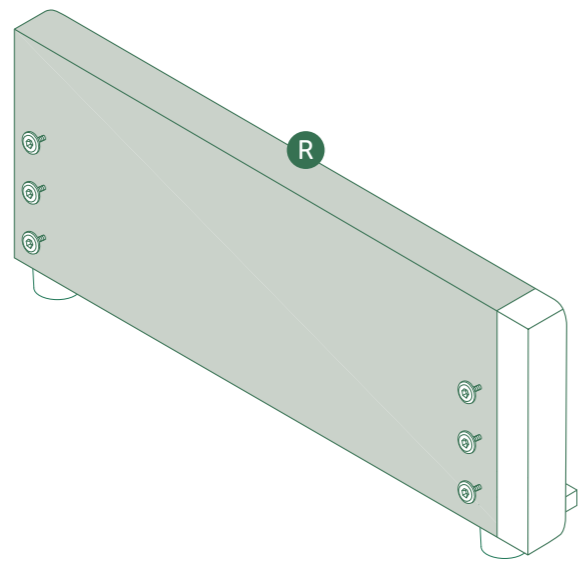

13

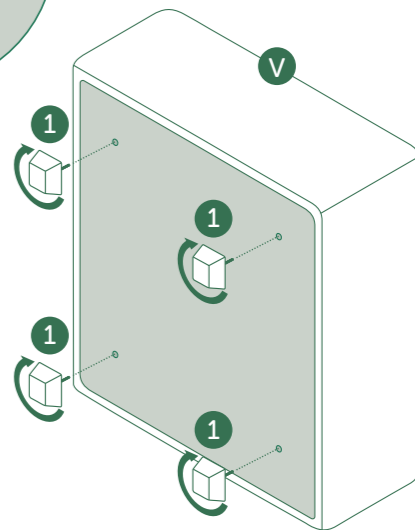
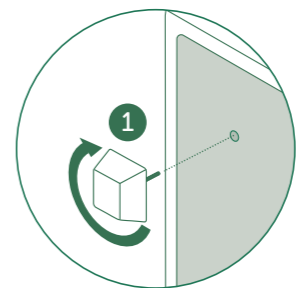
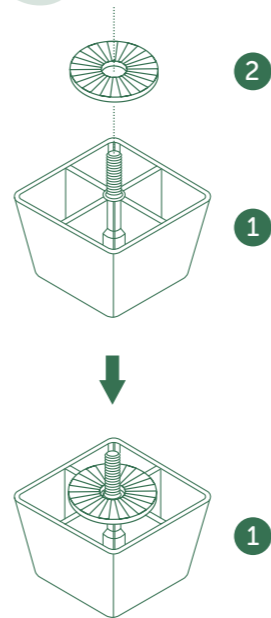

14

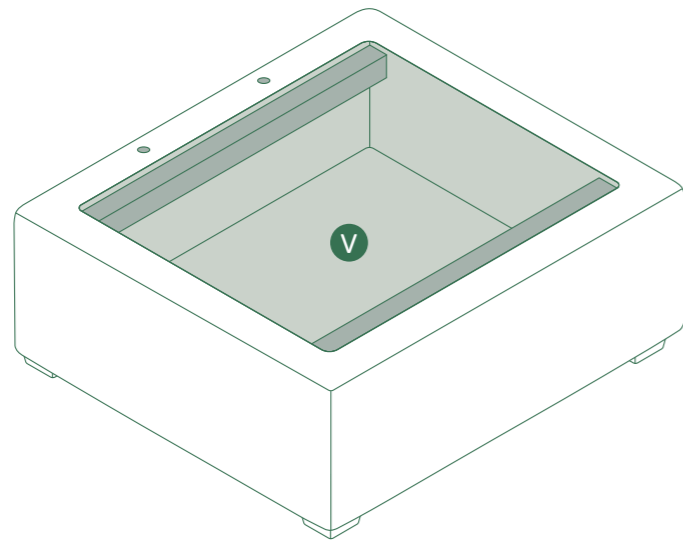

15

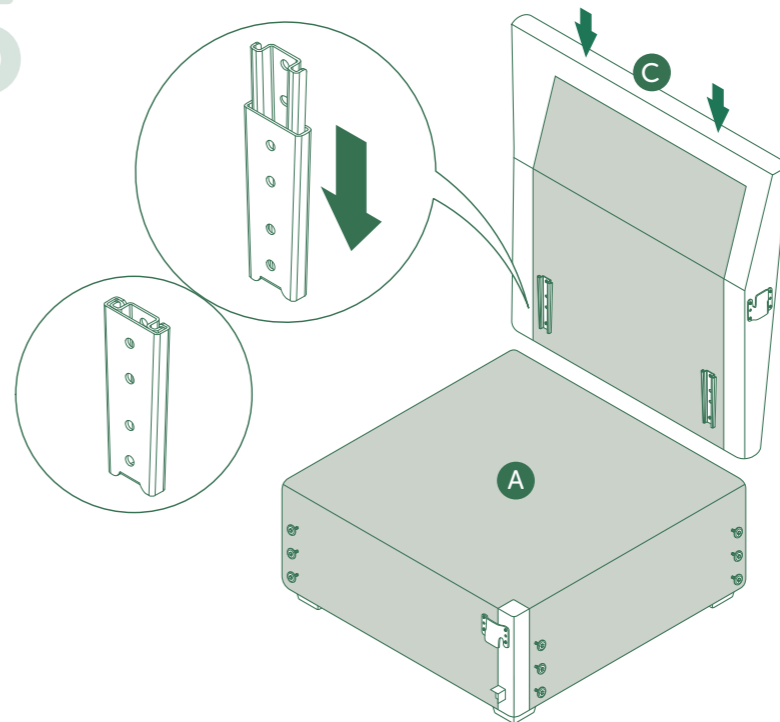

16

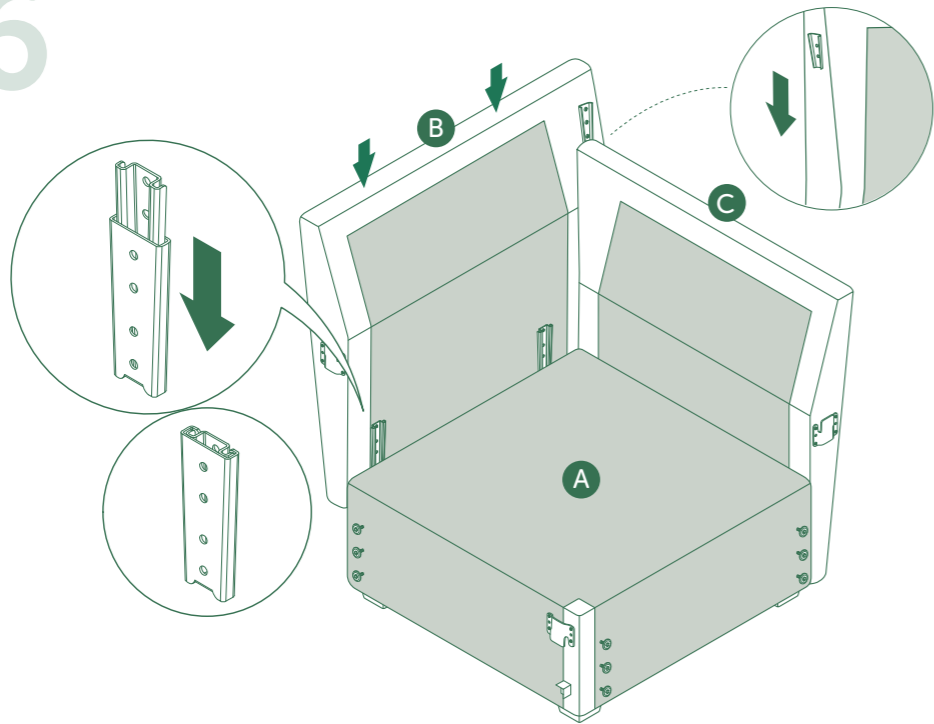

17

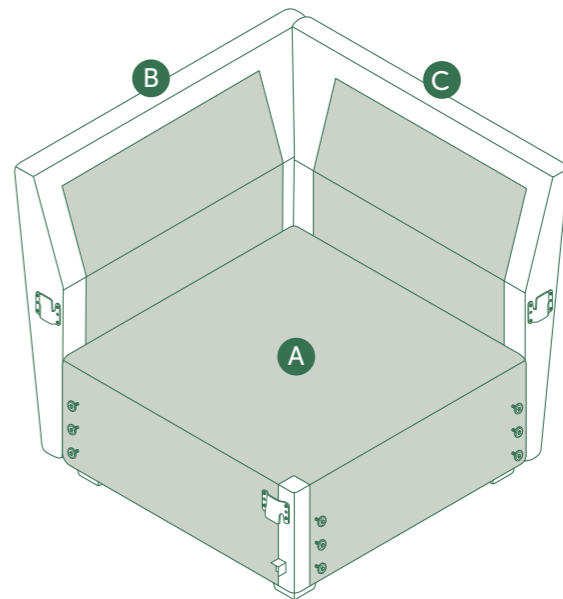

18

Part S,X,R

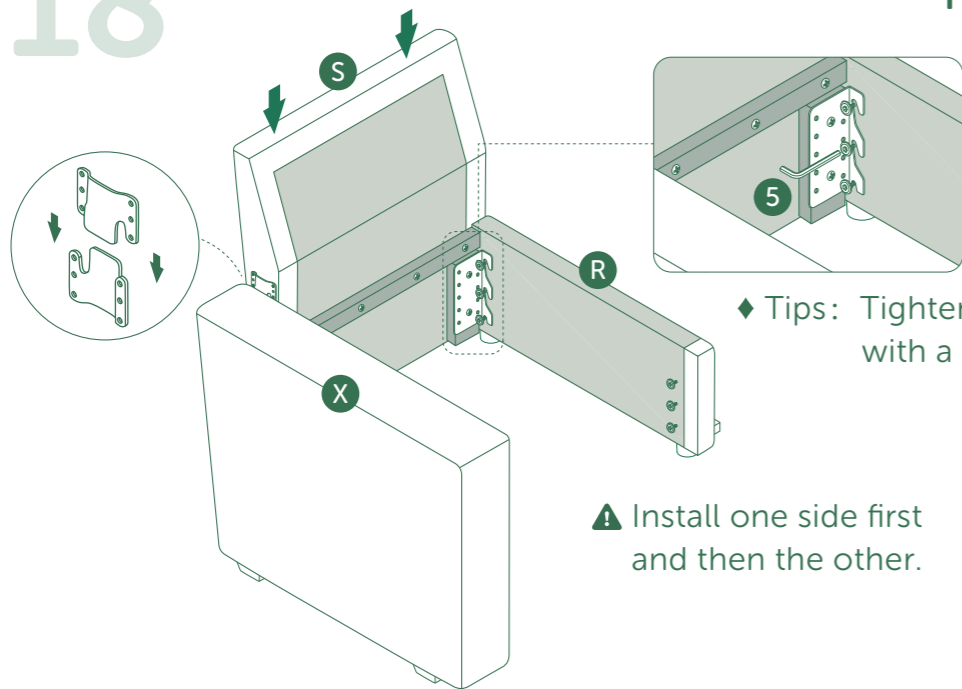

◆ Tips: Tighten the screw with a wrench

⚠ Install one side first and then the other.

19

Part Q

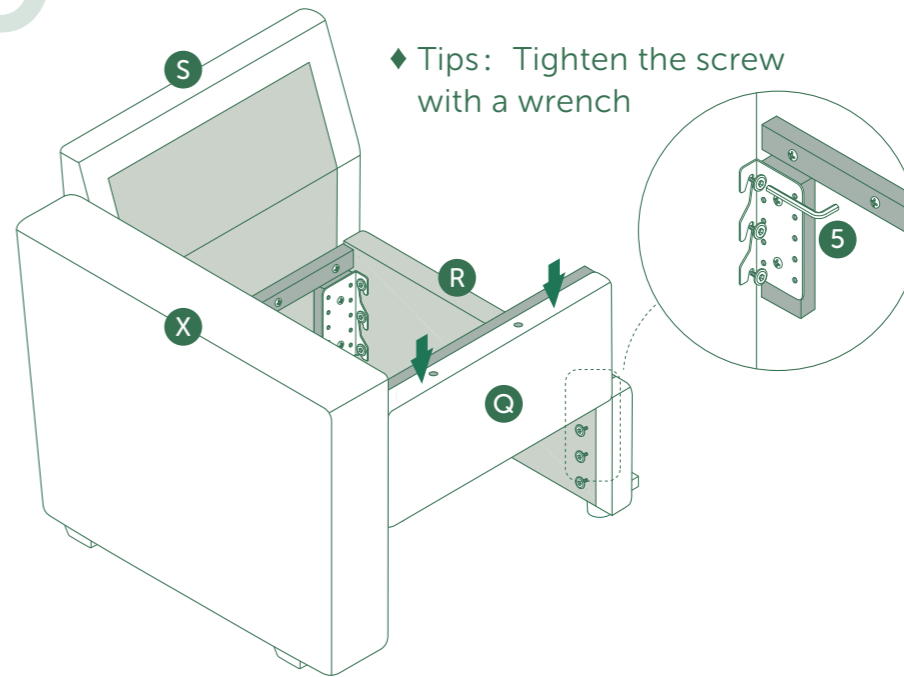

◆ Tips: Tighten the screw with a wrench

20

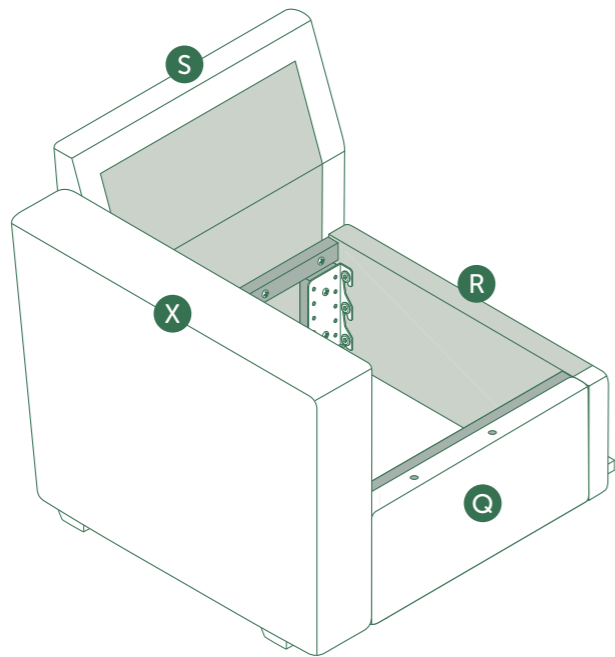

21

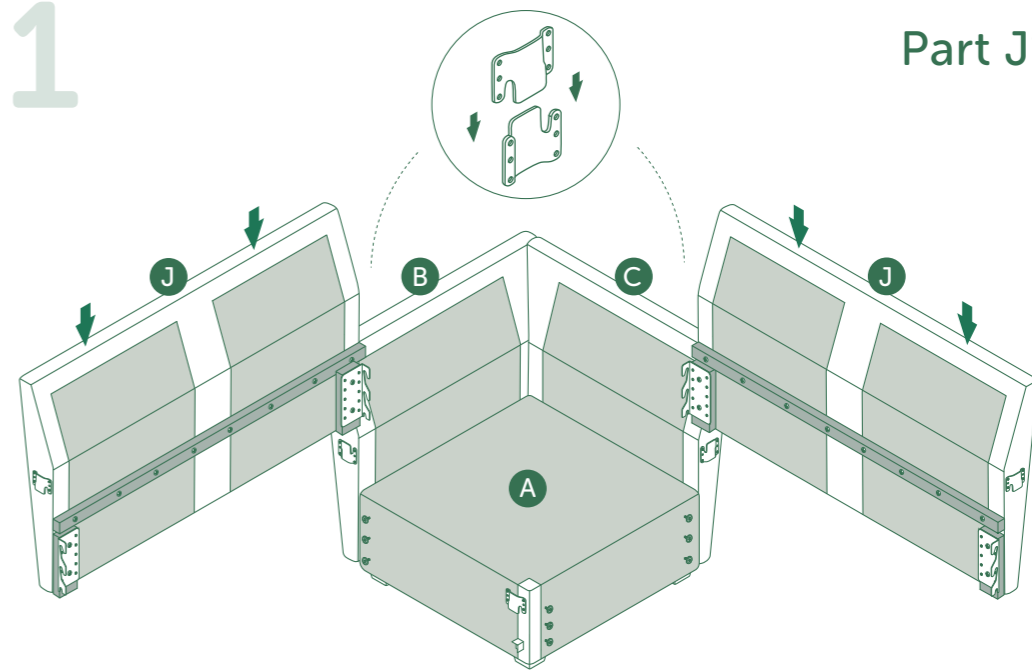

Part J*2

▲ Install one side first and then the other.

22

Part SXRQ.E

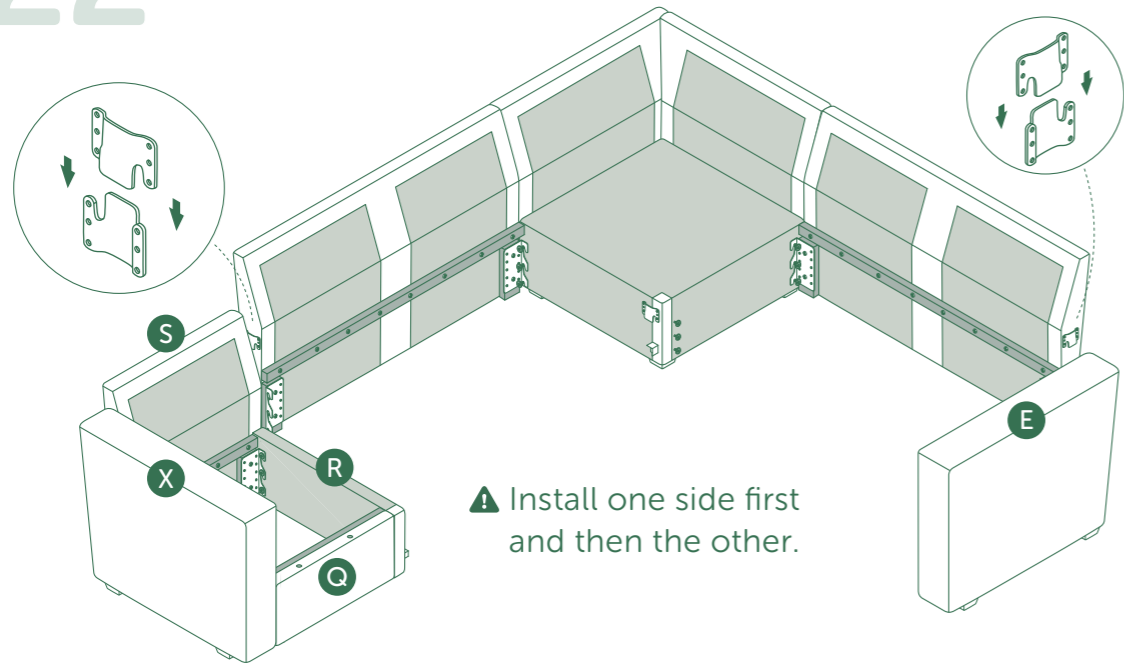

⚠ Install one side first and then the other.

23

Part N

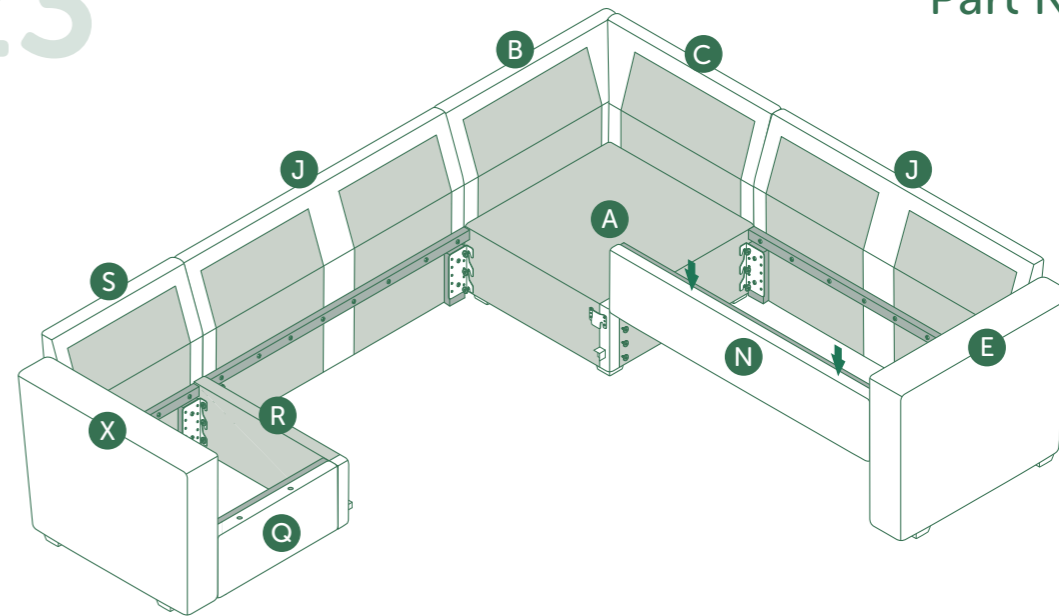

24

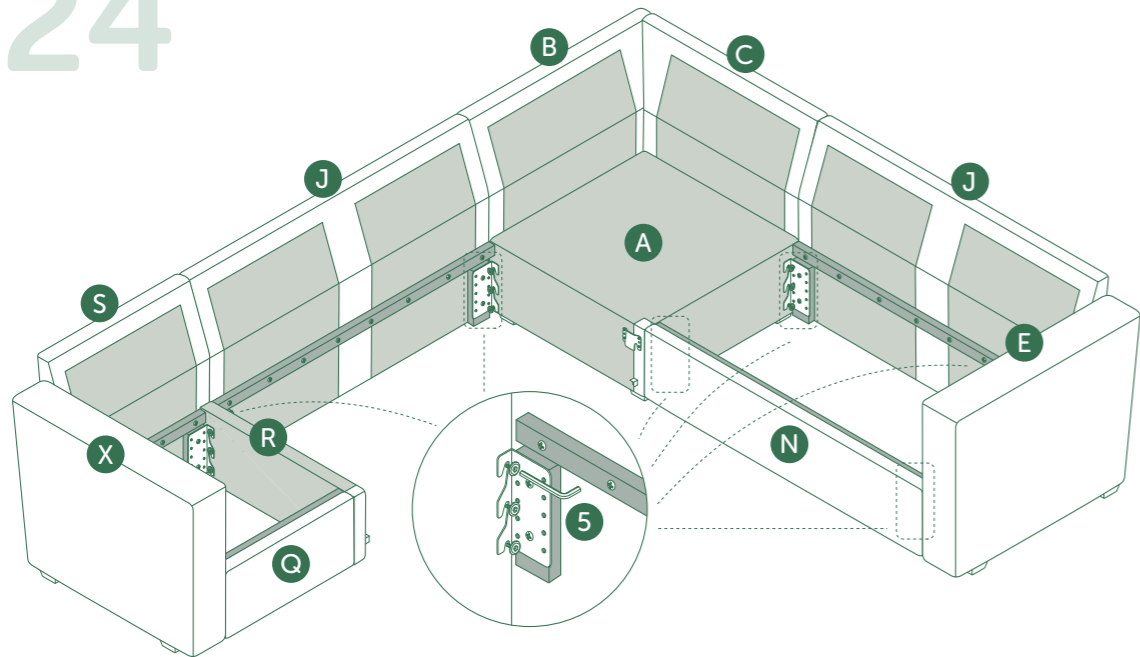

◆ Tips: Tighten the screw with a wrench

25

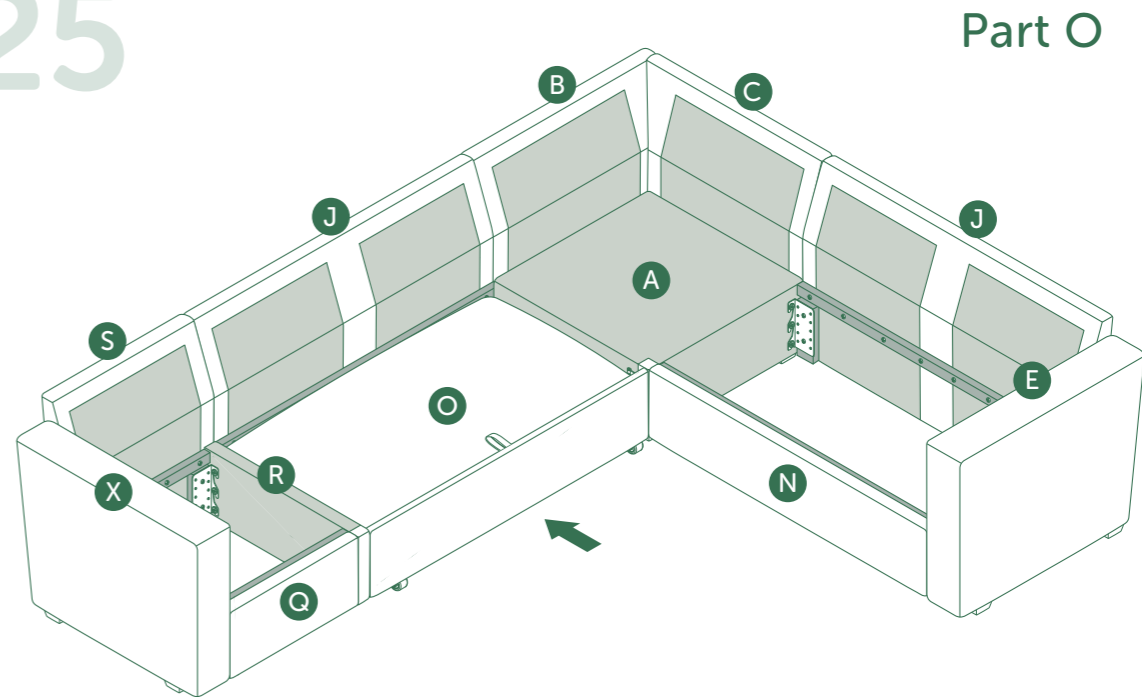

Part O

26

Part P

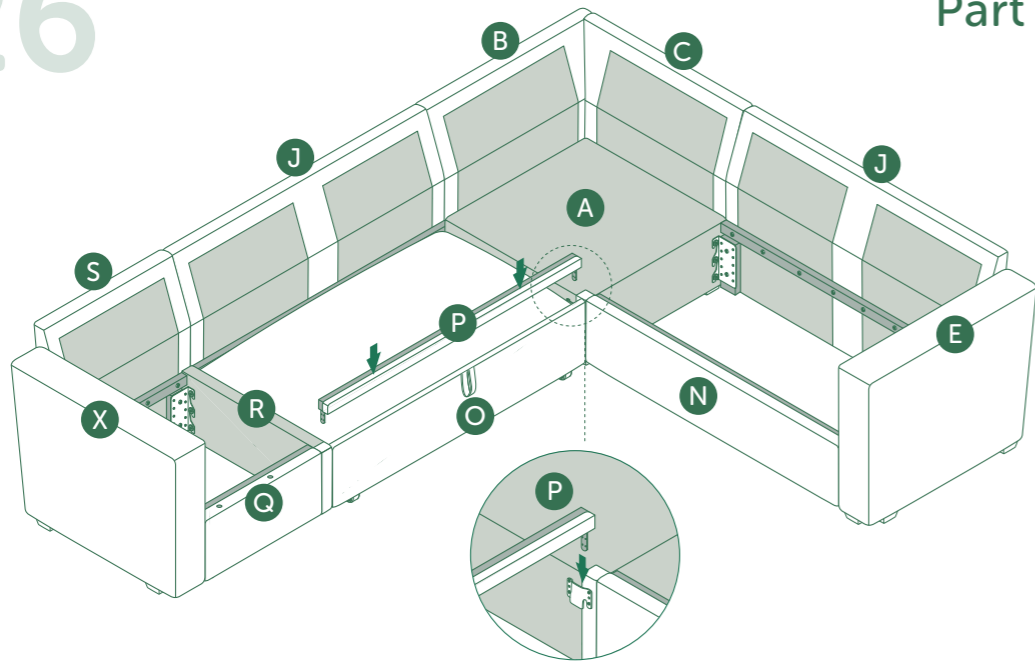

27

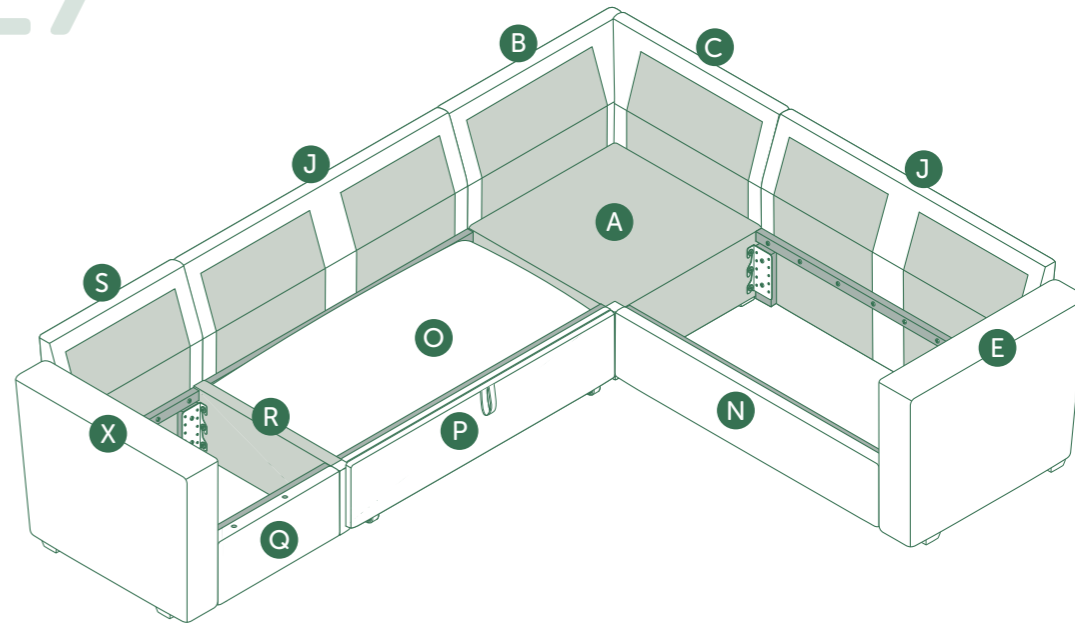

28

Part V

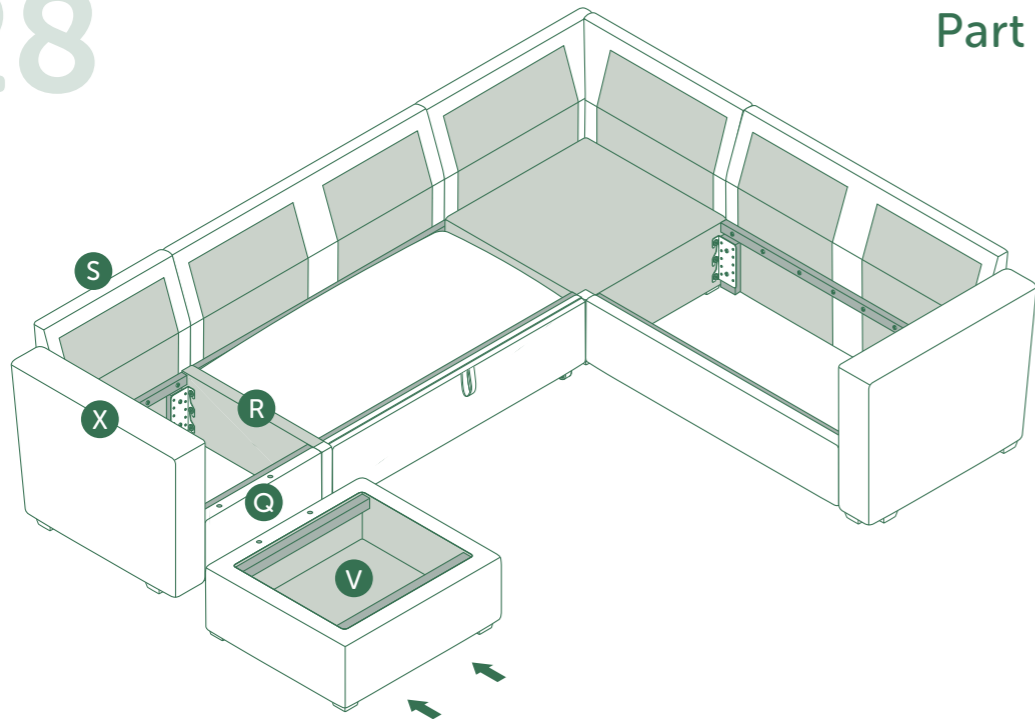

29

Part L*2
Part T*1
Part W*1
③*2

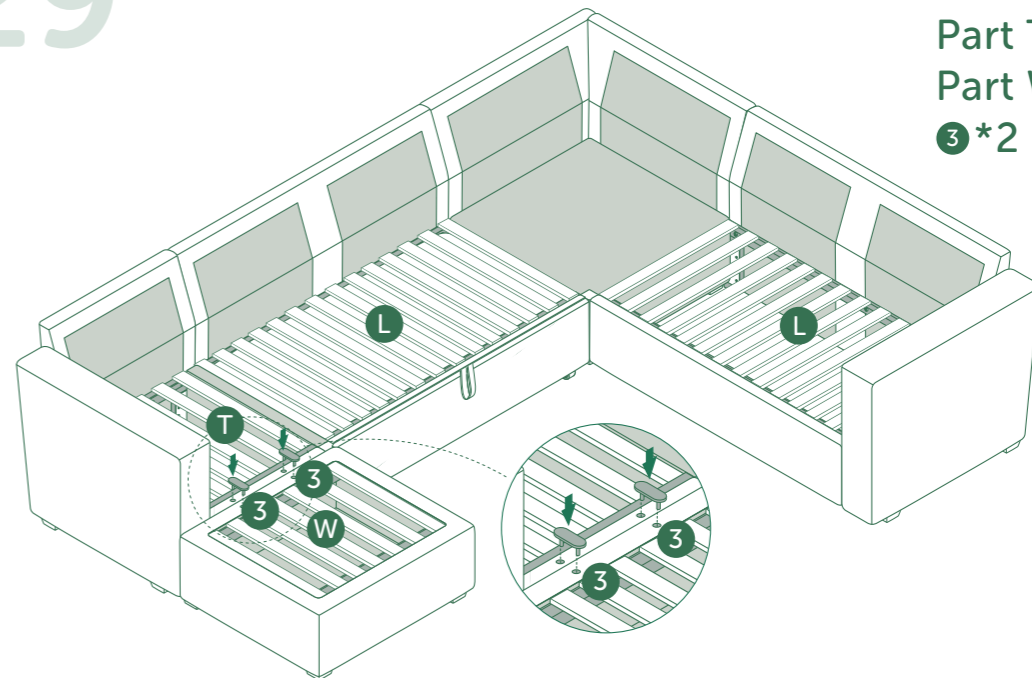

30

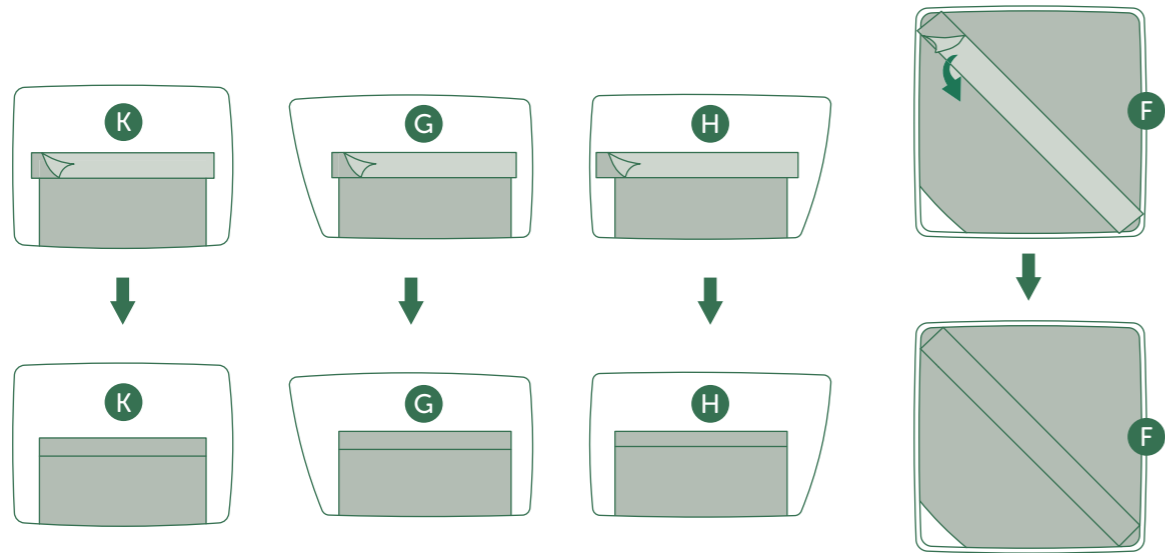

31

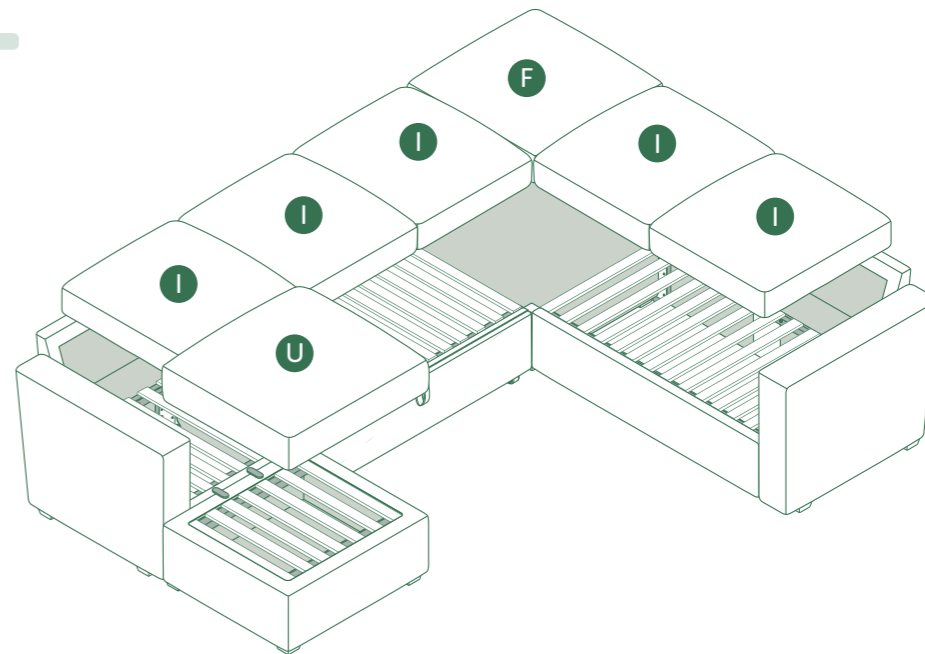

32

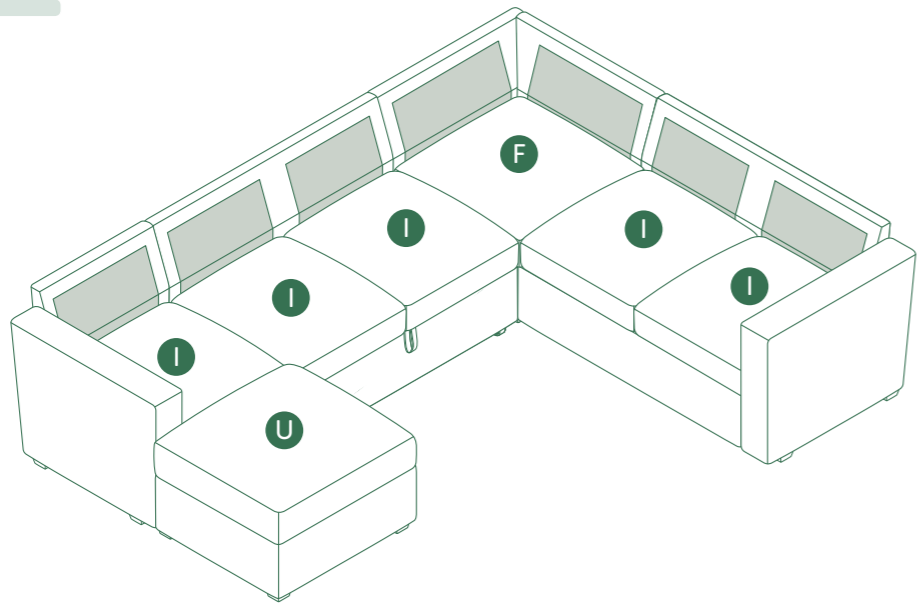

33

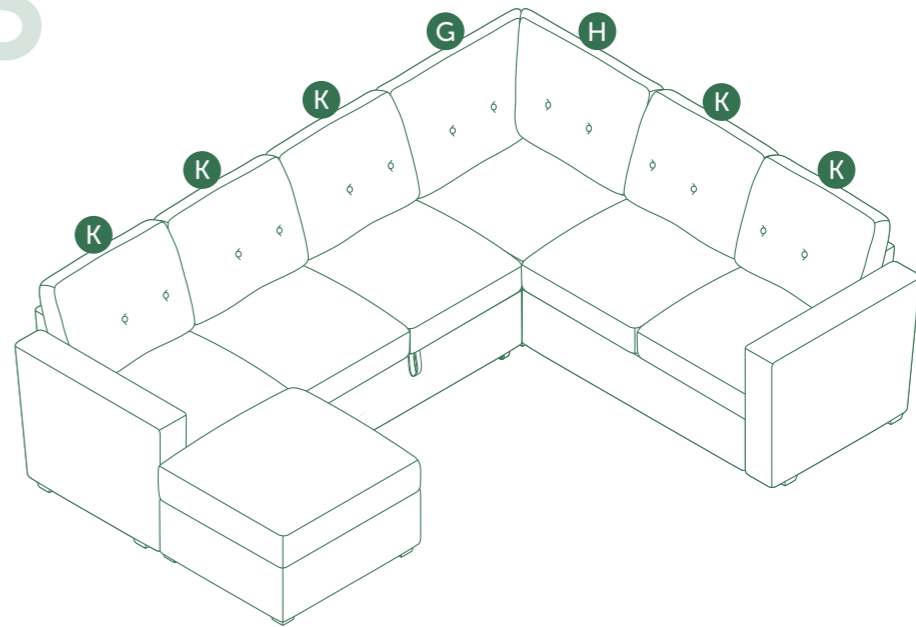

34

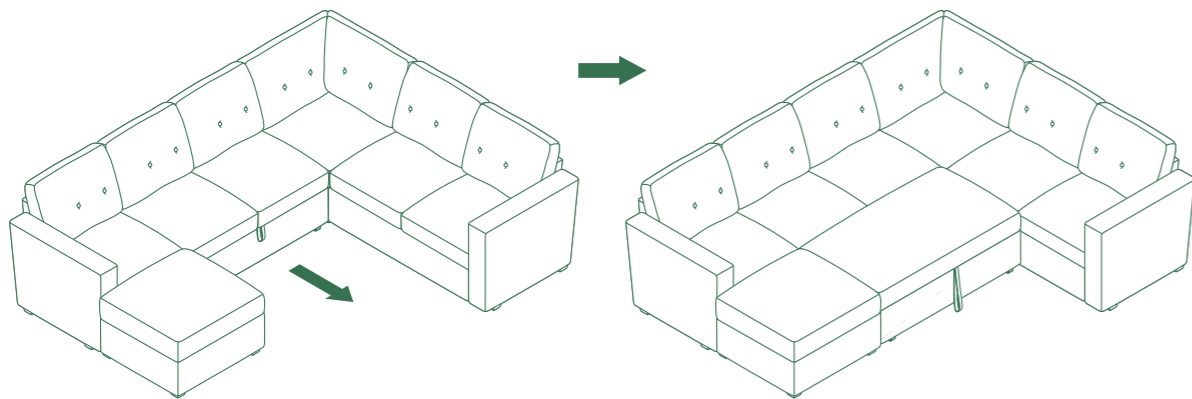

Finish / Terminar

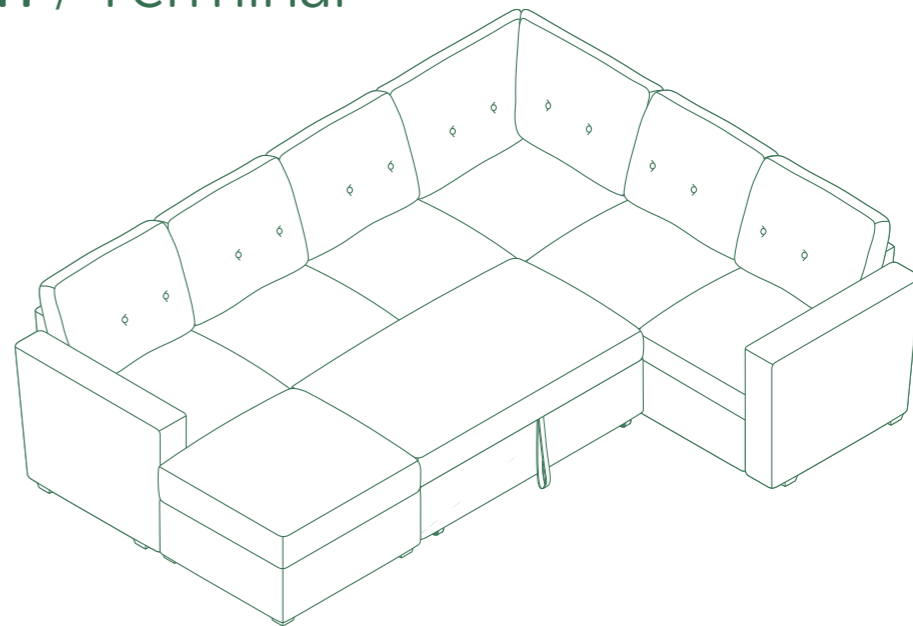

HONBAY

The HONBAY brand is committed to the design and application of furniture, creating applicable high-quality sofas for the diversity of interior space, and we focus on offering customers good shopping experience and professional customer service.

Customer Service: Support@honbayus.com

La marca HONBAY está comprometida con el diseño y la aplicación de muebles, creando sofás funcionales de alta calidad para la diversidad del espacio interior, y nos enfocamos en ofrecer una buena experiencia de compra y un servicio profesional al cliente.

Servicio al cliente: Support@honbayus.com

LIMITED WARRANTY

Our team would like to improve the quality of the customer service and make your experience as easy and smooth as possible.

Return Policy: This item could be returned within 30 days without any major reason. After we receive the returned item, we would check it and make sure that is not damaged then we will process the refund. For more details, please remember to check the above terms of RETURN/DAMAGE CLAIM INSTRUCTIONS.

The warranty product is one year from the date of your purchase. If this item is damaged within the warranty period, we will arrange for you the replacement parts free of charge. If the item is damaged for some personal reasons, we could also replace it for you, however, you would need to bear the cost of the replacement parts and shipping fees.

The exceptions or exclusions to this warranty are as follows:

1. Any warranty claim that is submitted after the limited warranty period won't be taken into consideration. We wouldn't be able to replace the item for you even at your cost.
2. This warranty does not the products which have been purchased by mistake.

In the case of having some defect in the material or handiwork that are covered by this item's warranty, HONBAY will repair or replace it for you without charging you any cost within a reasonable period of time. We reserve the right to require damaged parts to be returned to us upon our request. For HONBAY furniture standards, scars, brands, grain variations, wrinkles, color variations, etc. will be considered as normal characteristics and not interpreted as defects. We cannot guarantee that the leather will not be scratched or scuffed, as all leather furniture could get imperfections with the use.

If you have any questions concerning this warranty, please contact the HONBAY Customer Service department by sending an email to **Support@honbayus.com**. Be prepared to provide your name, address, daytime phone number, the model and purchase order number of the product, date of the purchase, and the store where it was ordered. All of these information provided by you, will help us to track your order easily and solve your problem in the shortest time.

This warranty gives you specific rights, and you still possess other rights, which vary in terms of each case.

GARANTÍA LIMITADA

Nuestro equipo desea mejorar la calidad del servicio al cliente para que su experiencia sea lo más fácil.

Política de Devolución: Este artículo puede devolverse en un plazo de 30 días sin ningún motivo. Después de recibir el artículo devuelto, lo revisaremos y nos aseguraremos de que no está dañado, y luego procesaremos el reembolso. Para obtener más detalles, recuerde consultar los términos de las INSTRUCCIONES DE RECLAMACIÓN DE DEVOLUCIÓN / DAÑOS mencionados anteriormente.

La garantía del producto es de un año a partir de la fecha de compra. Si el producto se daña dentro del período de garantía, le proporcionaremos piezas de repuesto gratuitamente. Si el producto se daña por razones personales, también podríamos reemplazarlo por usted, sin embargo, deberá asumir el costo de las piezas de repuesto y el gasto de envío.

Las excepciones o exclusiones a esta garantía son las siguientes:

1. No se tendrá en cuenta ninguna reclamación de garantía que se presente después del período de garantía limitado. No podremos reemplazar el artículo por usted, incluso a su costo.
2. Esta garantía no se aplica a los productos adquiridos por error.

En caso de defectos en los materiales o trabajo manual cubiertos por esta garantía de este artículo, HONBAY lo reparará o reemplazará por usted sin cobrarle ningún costo dentro de un período razonable. Nos reservamos el derecho de exigir que las piezas dañadas nos sean devueltas a nuestra petición. Según las normas de los muebles HONBAY, cicatrices, marcas, variaciones de vetas, cambios de color, etc., se considerarán características normales en lugar de defectos. No podemos garantizar que el cuero no se raye ni se rasque, ya que todo el cuero puede tener defectos durante su uso.

Si tiene alguna pregunta sobre esta garantía, por favor comuníquese con el departamento de Servicio al Cliente de HONBAY enviando un correo electrónico a **Support@honbayus.com**. Se debería proporcionar su nombre, dirección, número de teléfono, el modelo y el número de pedido, la fecha y el lugar de compra. Toda esta información proporcionada por usted nos ayudará a rastrear su pedido fácilmente y resolver su problema en el menor tiempo posible.

Esta garantía le otorga derechos específicos, y aún posee otros derechos, que varían en función de cada caso.