

# *ASSEMBLY INSTRUCTIONS*



***Chair***

# ASSEMBLY INSTRUCTIONS

## ASSEMBLY TIPS:

1. Remove hardware from box and sort by size.
2. Please check to see that all hardware and parts are present prior to start of assembly.
3. Please follow attached instructions in the same sequence as numbered to assure fast & easy assembly.



### WARNING!

1. Don't attempt to repair or modify parts that are broken or defective. Please contact the store immediately.
2. This product is for home use only and not intended for commercial establishments.

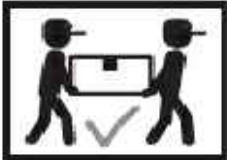

ASSEMBLY TIME

10 MINUTES

## PARTS IDENTIFICATION

A SEAT



1PC

B BACK

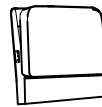

1PC

C RIGHT ARM

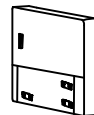

1PC

D LEFT ARM

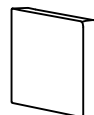

1PC

E LEG



4PCS

## HARDWARE IDENTIFICATION

1 PLASTIC WASHER  
(Ø50 x 2mm - BLK)



4PCS

# ASSEMBLY INSTRUCTIONS

## STEP 1

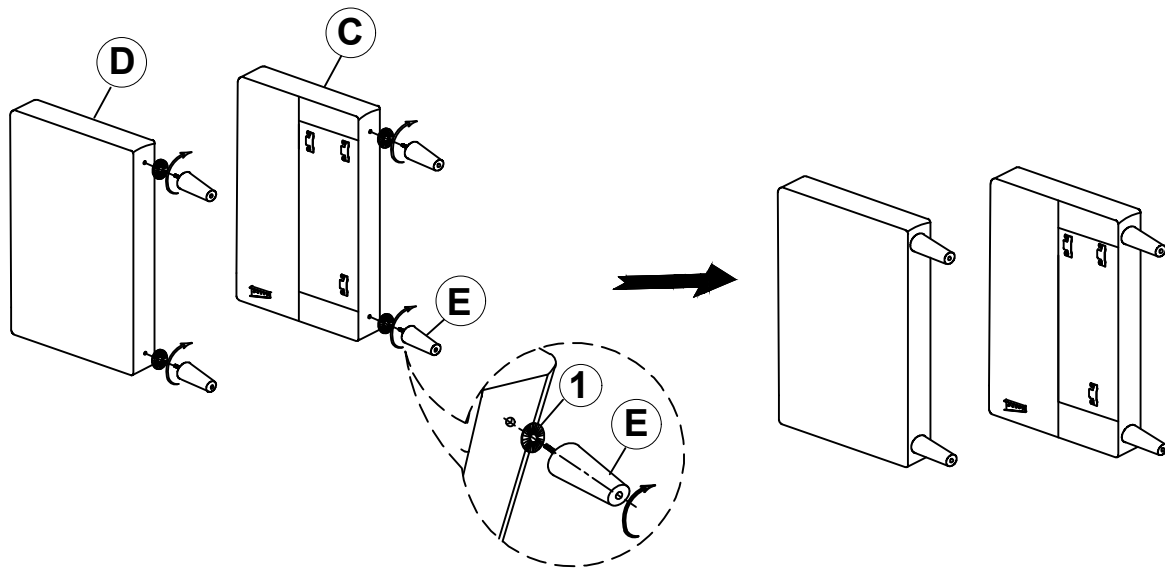

## STEP 2

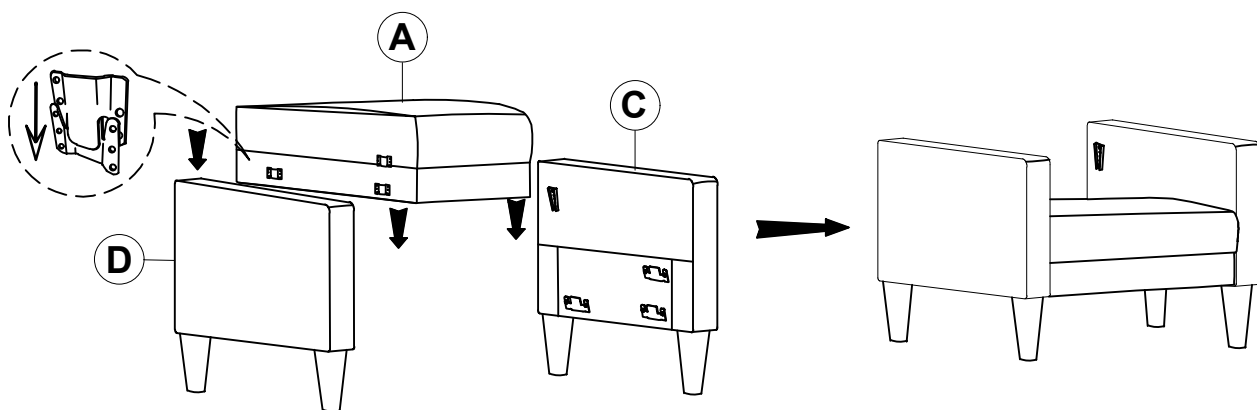

## STEP 3 COMPLETE

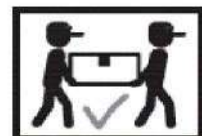
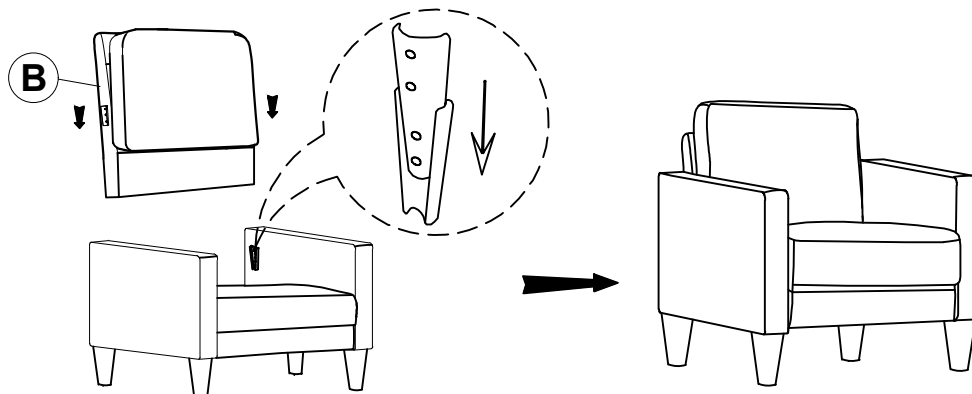

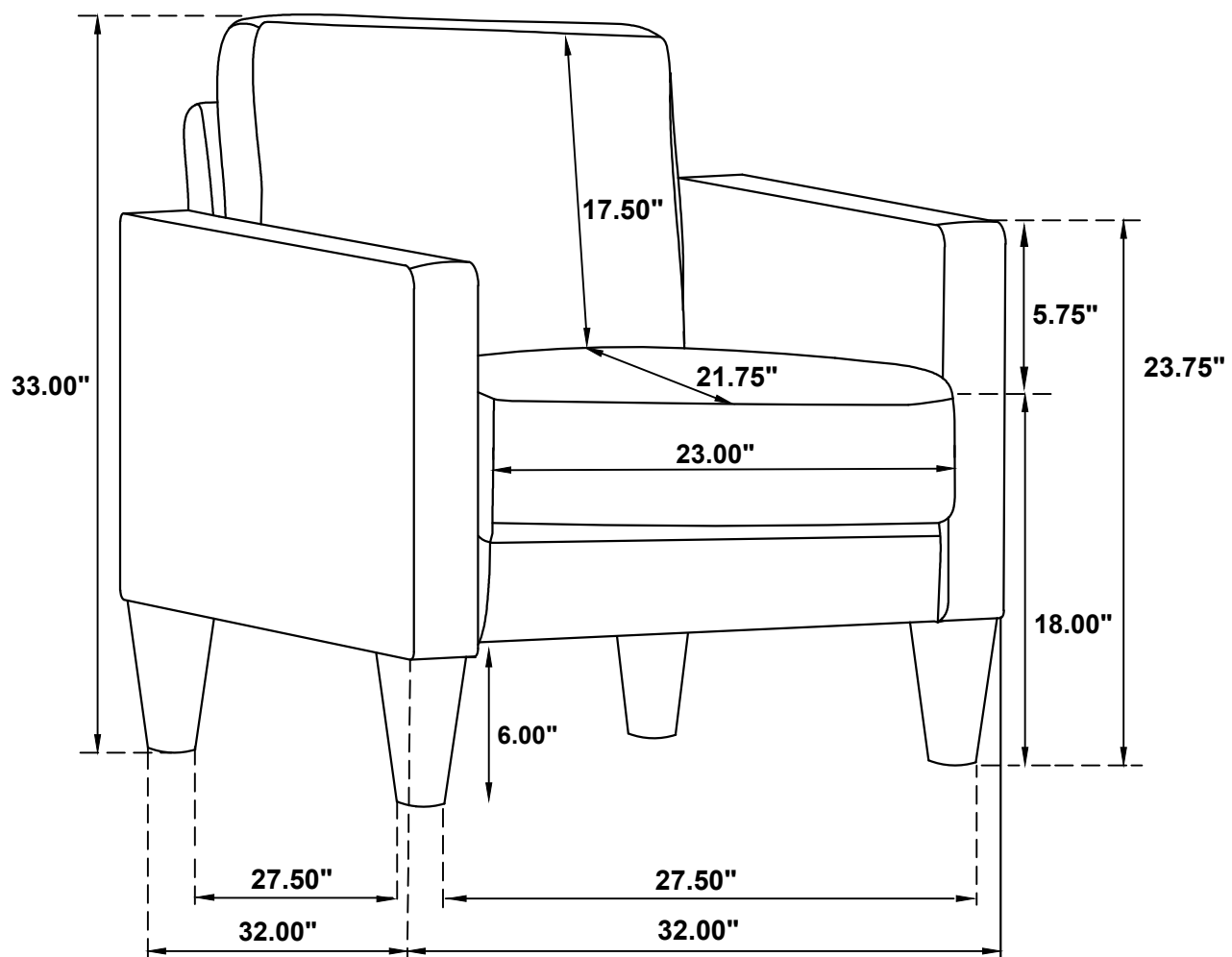

Note: Dimension tolerance  $\pm 5\%$