

**ASSEMBLY INSTRUCTION**  
**BUNK BED**  
**SKU : BW00147**

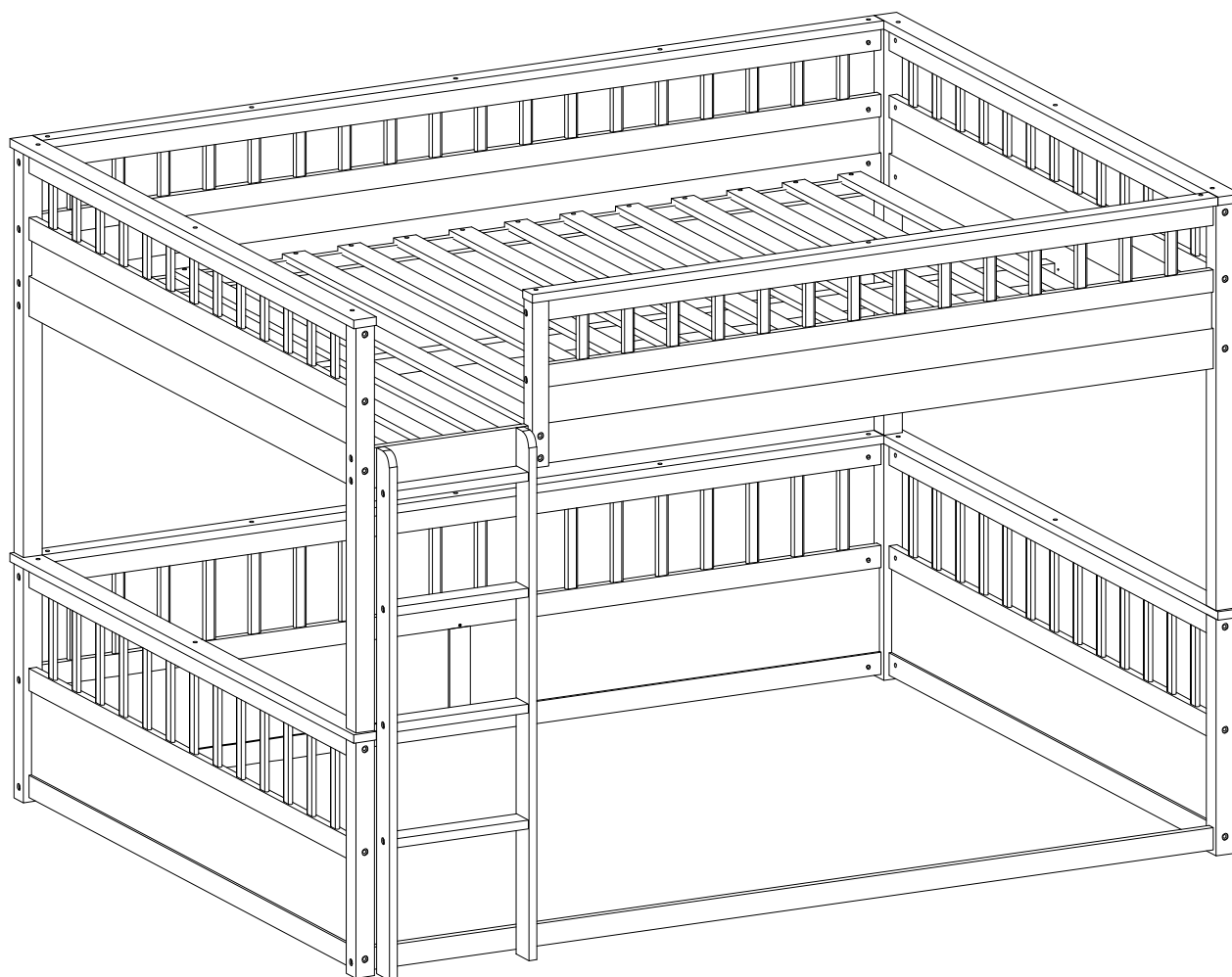



# SAFETY WARNING



1. This bed is designed for use only mattress (es) meeting the following specifications on the upper bunk, and lower bunk:

Up bed







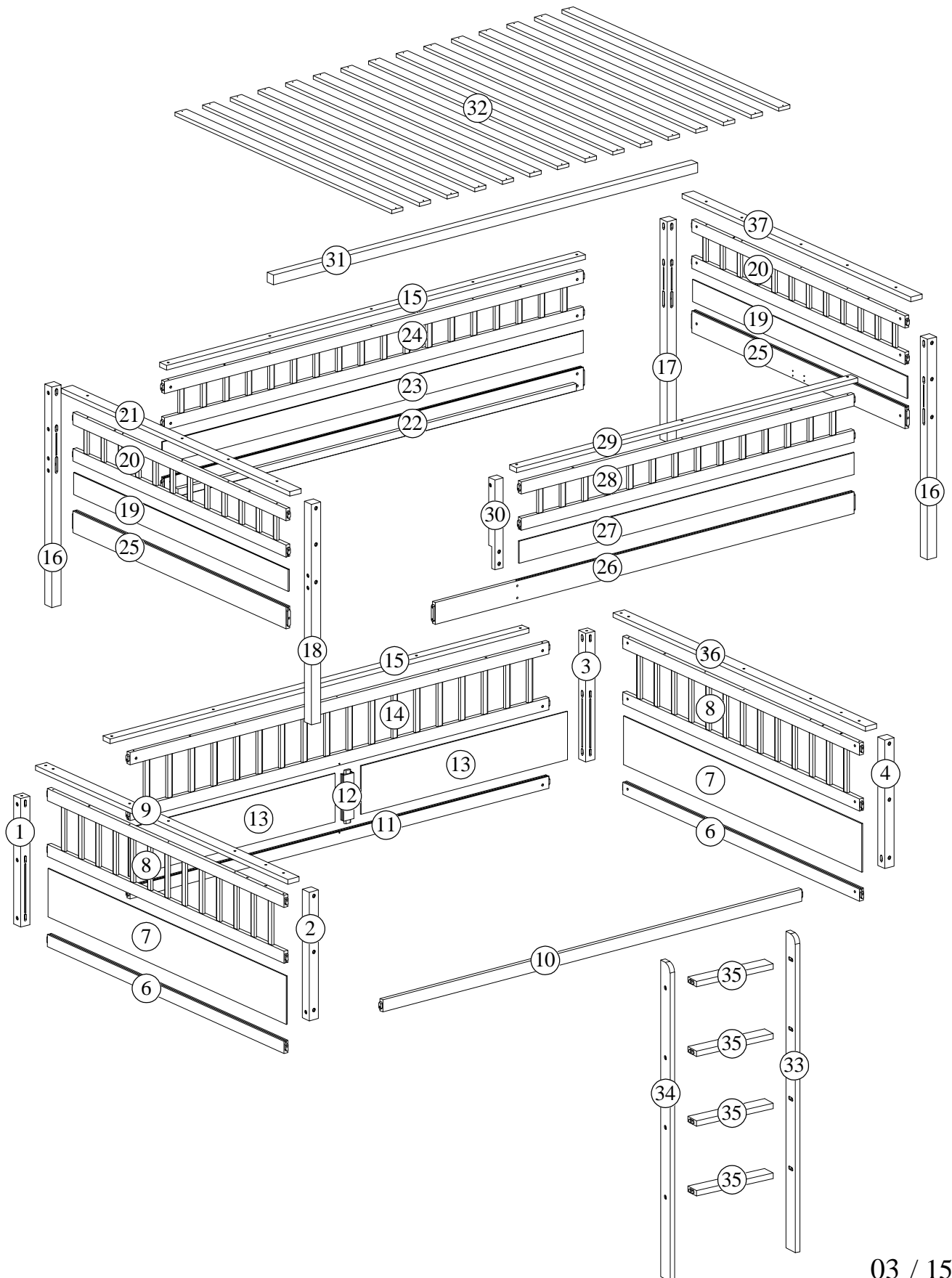

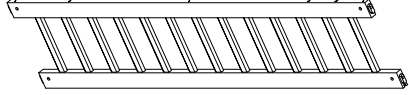
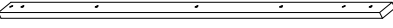

Bed type	Length	Width	Thickness
Queen Standard	80"	60"	6" max

2. Replacement parts, including additional guardrails, maybe obtained from any of our BUYER: Shenzhen Yuefeng Zhiqi Technology Co., Ltd.  
A708-E1, 7th Floor, Block A, Building A, Jiangsu Building, No. 6013 Yitian Road, Fuxin Community, Lianhua Street, Futian District, Shenzhen
3. Follow the information on the warnings appearing on the upper bunk bed end structure and on the carton. Do not remove warning label from bed.
4. Always use the recommended size mattresses or mattress supports, or both, to help prevent the likelihood of entrapment or falls.
5. Surface of mattress must be at least 5" (127mm) below the upper edge of guardrails.
6. Do not allow children under 6 years of age to use the upper bunk.
7. Periodically check and ensure that the guardrail, ladder, and other components are in their proper position, free from damage, and that all connectors are tight.
8. Do not allow horseplay on or under the bed and prohibit jumping on the bed.
9. Always use the ladder for entering and leaving the upper bunk.
10. Do not use substitute part. Contact the manufacture or dealer for replacement part.
11. Use of a night light may provide added safety precaution for a child using the upper bunk.
12. Always use guardrails on both long sides of the upper bunk. If the bunk bed will be placed next to the wall, the guardrail that runs the full length of the bed should be placed against the wall to prevent entrapment between the bed and wall.
13. The use of water or sleep flotation mattresses is prohibited.
14. STRANGULATION HAZARD - Never attach or hang items to any part of the bunk bed that are not designed for use with the bed; for example, but not limited to, hook, belts and jump ropes.
15. Keep these instruction for future reference.
16. Prohibit more than one person on upper bunk
17. We recommend assembling your bunk bed on the shipping carton to protect your floor or carpet.
18. Be certain all staples are out of the box before beginning assembly on the shipping carton.



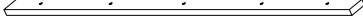
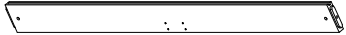
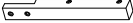

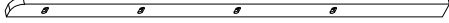

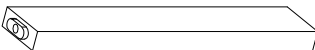
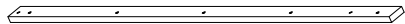
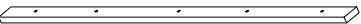

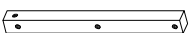
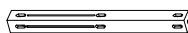
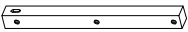

# ASSEMBLY INSTRUCTION

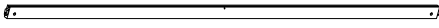
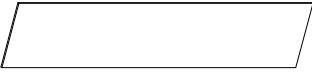
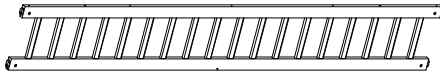

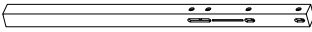
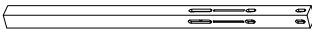
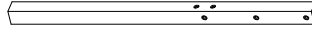
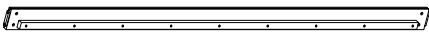
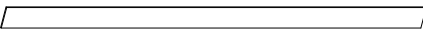

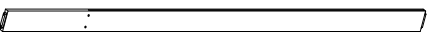
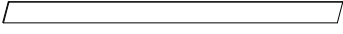







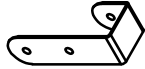

## Part List : BW00147

<p><b>6</b></p>  <p>Lower Hip Bar-2pcs Barre de hanche inférieure</p>	<p><b>7</b></p>  <p>Lower Side Board-2pcs Panneau latéral inférieur</p>	<p><b>8</b></p>  <p>Lower Hip Frame-2pcs Cadre de hanche inférieur</p>
<p><b>9</b></p>  <p>Left Headboard(Floor 1)-1pc Tête de lit gauche (étage 1)</p>	<p><b>12</b></p>  <p>Frame Standing Puzzle-1pc Puzzle Cadre Debout</p>	<p><b>19</b></p>  <p>Upper side board-2pcs Panneau latéral supérieur</p>
<p><b>20</b></p>  <p>Upper hip frame-2pcs Cadre de hanche supérieur</p>	<p><b>21</b></p>  <p>Left side frame cover-1pc Couvercle de cadre latéral gauche</p>	<p><b>25</b></p>  <p>Lower hip bar-2pcs Barre de hanche inférieure</p>
<p><b>30</b></p>  <p>Railing Puzzle-1pc Puzzle de garde-corps</p>	<p><b>32</b></p>  <p>Slat-15pcs Lamelle</p>	<p><b>33</b></p>  <p>Right foot of the ladder-1pc Pied droit de l'échelle</p>
<p><b>34</b></p>  <p>Left foot of the ladder-1pc Pied gauche de l'échelle</p>	<p><b>35</b></p>  <p>Steps-4pcs Mesures</p>	<p><b>36</b></p>  <p>Lower side frame cover-1pc Couvercle du cadre latéral inférieur</p>
<p><b>37</b></p>  <p>Upper side frame cover-1pc Couvercle du cadre latéral supérieur</p>		

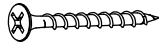
# Part List : BW00147

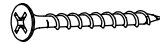
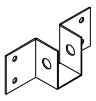
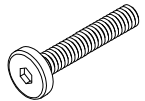
<p><b>1</b></p>  <p>Left Hind Leg(Floor 1)-1pc Patte arrière gauche (sol 1)</p>	<p><b>2</b></p>  <p>Left Front Leg(Floor 1)-1pc Jambe avant gauche (sol 1)</p>	<p><b>3</b></p>  <p>Right Hind Leg(Floor 1)-1pc Patte arrière droite (sol 1)</p>
<p><b>4</b></p>  <p>Right Front Leg(Floor 1)-1pc Jambe avant droite (sol 1)</p>	<p><b>10</b></p>  <p>Front and Bottom Crossbar-1pc Barre transversale avant et inférieure</p>	<p><b>11</b></p>  <p>Lower Back Cross Bar-1pc Barre transversale pour le bas du dos</p>
<p><b>13</b></p>  <p>Back Frame-2pcs Cadre arrière</p>	<p><b>14</b></p>  <p>Rear Frame-1pc Cadre arrière</p>	<p><b>15</b></p>  <p>Rear frame railing cover-2pcs Couvercle de garde-corps de cadre arrière</p>
<p><b>16</b></p>  <p>Left front right hind leg(Foor 2)-2pcs Patte avant gauche et patte arrière droite (Foor 2)</p>	<p><b>17</b></p>  <p>Right Hind Leg(Foor 2)-1pc Patte arrière droite (Foor 2)</p>	<p><b>18</b></p>  <p>Left Front Leg(Foor 2)-1pc Jambe avant gauche (ped 2)</p>
<p><b>22</b></p>  <p>Back bed shoulder-1pc Épaule du lit arrière</p>	<p><b>23</b></p>  <p>Rear Railing-1pc Garde-corps arrière</p>	<p><b>24</b></p>  <p>Rear frame-1pc Cadre arrière</p>
<p><b>26</b></p>  <p>Front Bed Shoulder-1pc Épaule avant du lit</p>	<p><b>27</b></p>  <p>Front railing-1pc Garde-corps avant</p>	<p><b>28</b></p>  <p>Front railing frame-1pc Cadre de garde-corps avant</p>
<p><b>29</b></p>  <p>Front railing-1pc Garde-corps avant</p>	<p><b>31</b></p>  <p>Bed rail support-1pc Support de barrière de lit</p>	

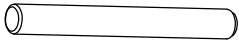
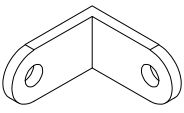

# Hardware List : BW00147

<p><b>A</b></p>  <p>Ø8 x 30 mm Wood dowel-14pcs Cheville en bois</p>	<p><b>B</b></p>  <p>Ø1/4" x 80 mm Hex-Head bolts-48pcs Boulons à tête hexagonale</p>	<p><b>C</b></p>  <p>Ø1/4" x 60 mm Hex-Head bolts-8pcs Boulons à tête hexagonale</p>
<p><b>D</b></p>  <p>Ø1/4" x 12 mm Horizontal-Hole bolts-56pcs Boulons à trou horizontal</p>	<p><b>E</b></p>  <p>U bracket-2pcs Support en U</p>	<p><b>F</b></p>  <p>Ø1/4" x 16 mm T-nut-2pcs Écrou en T</p>
<p><b>G</b></p>  <p>M4 x 35 mm Wood Screws-35pcs Vis à bois</p>	<p><b>H</b></p>  <p>Allen Key-1pc Clé Allen</p>	<p><b>J</b></p>  <p>M4 x 15 mm Wood Screws-16pcs Vis à bois</p>
<p><b>K</b></p>  <p>Metal bracket-2pcs Support en métal</p>	<p><b>L</b></p>  <p>Ø1/4" x 30 mm Hex-Head bolts-1pc Boulons à tête hexagonale</p>	<p><b>M</b></p>  <p>Ø1/4" x 50 mm Hex-Head bolts-1pc Boulons à tête hexagonale</p>
<p><b>N</b></p>  <p>Ø10 x 90 mm Round iron bar-4pcs Cheville en bois</p>	<p><b>O</b></p>  <p>Angle Metal-2pcs Angle en métal</p>	<p><b>P</b></p>  <p>M4 x 30 mm Wood Screws-34pcs Vis à bois</p>

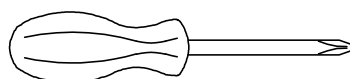
ASSEMBLY TOOLS REQUIRED ( NOT INCLUDED )



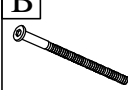

# STEP1:

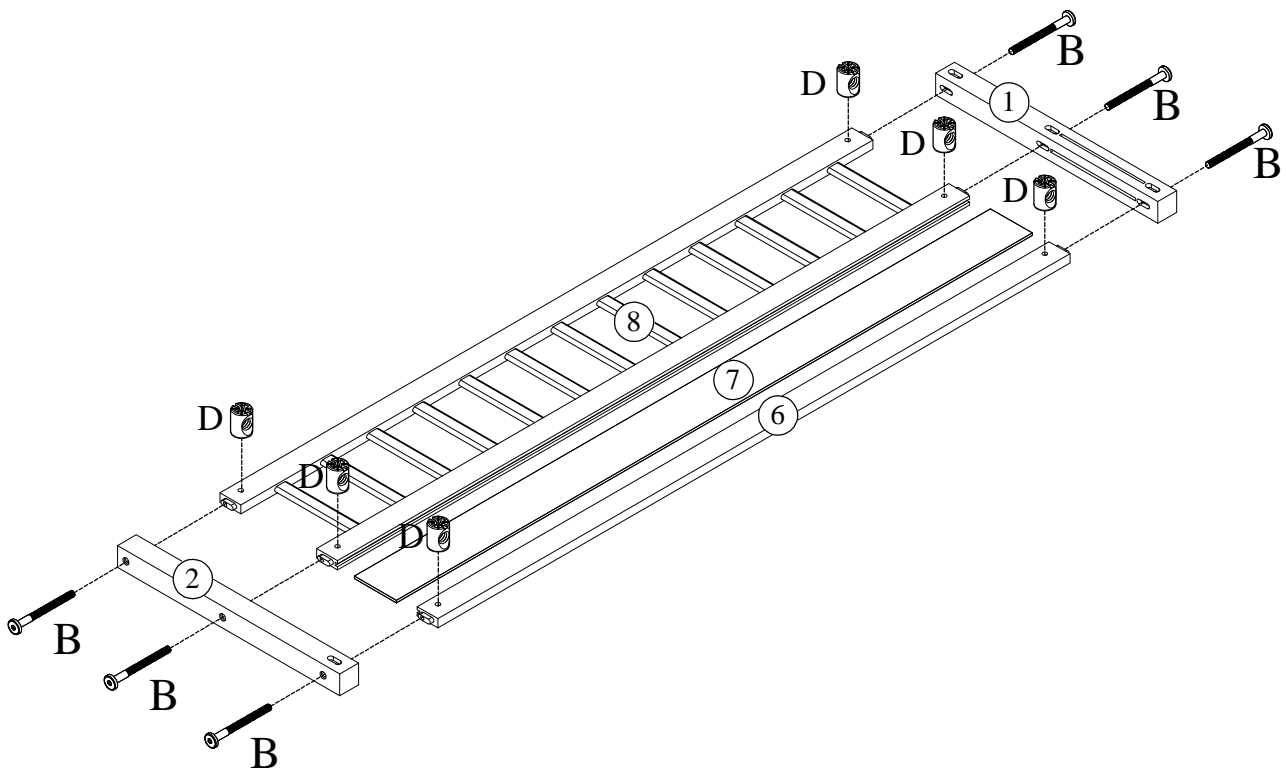
<b>B</b> 	<b>D</b> 
6PCS	6PCS

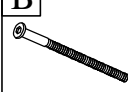

# STEP2:

<b>B</b> 	<b>D</b> 
6PCS	6PCS

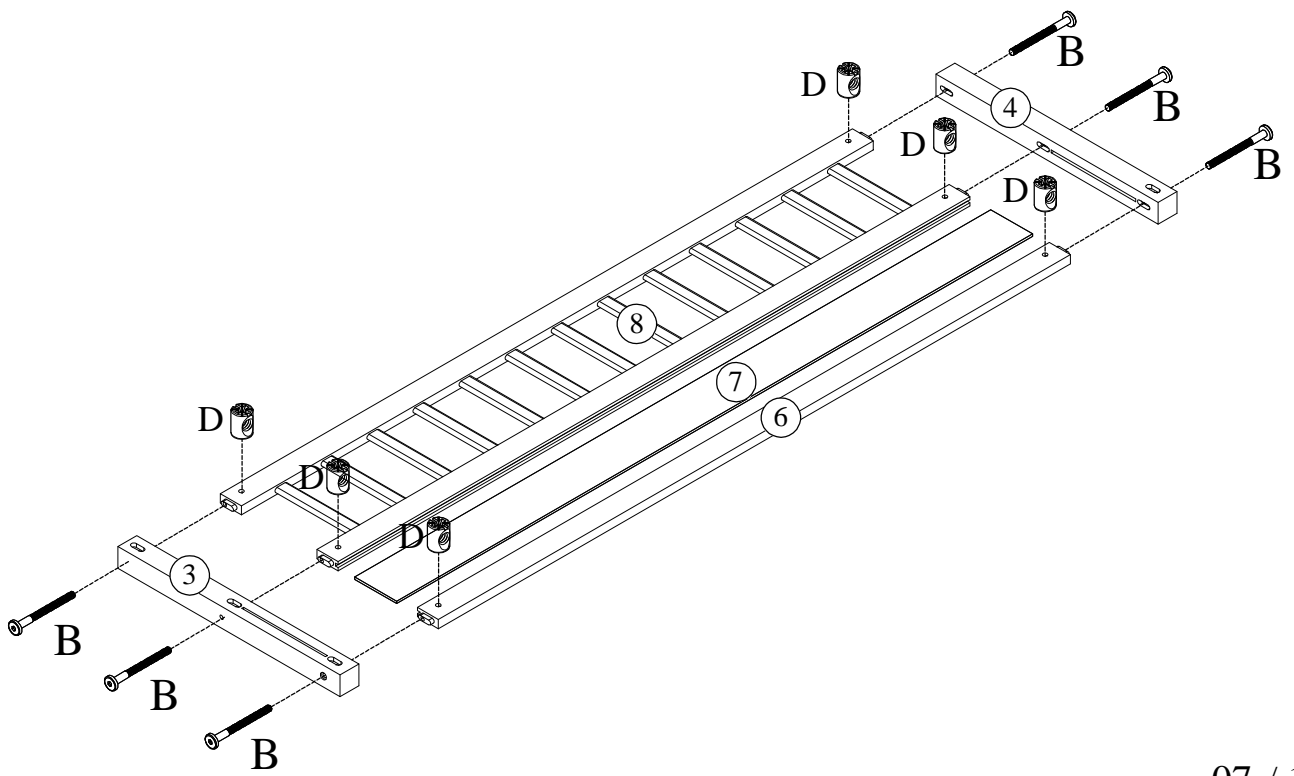

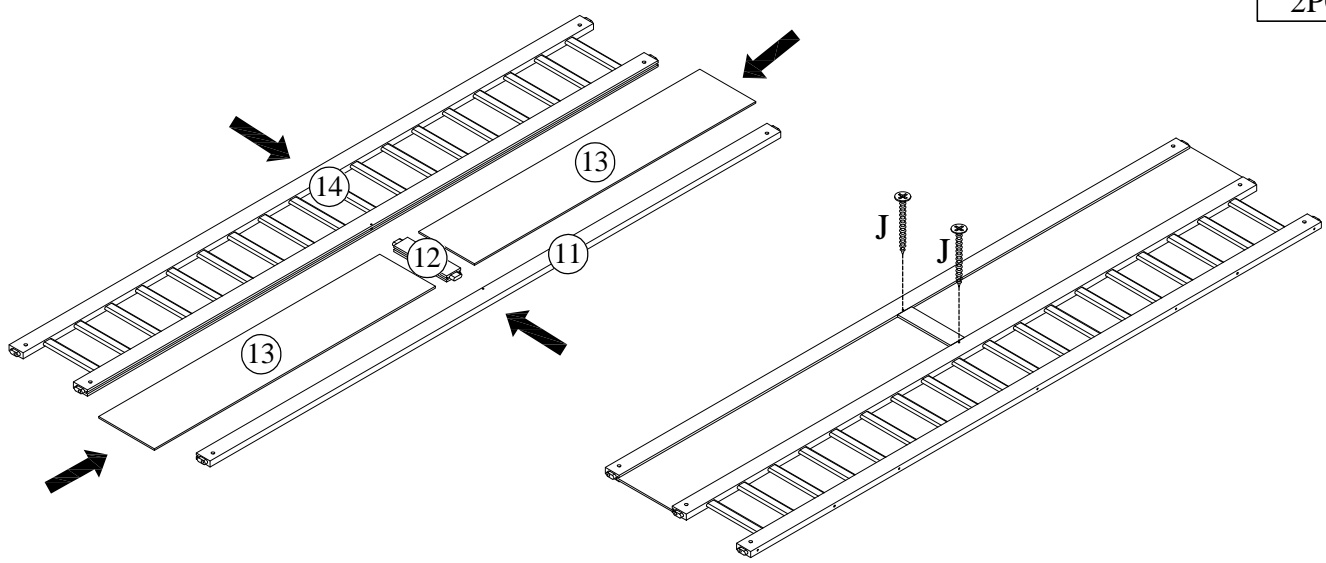

# STEP3:

J

2PCS

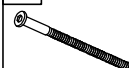

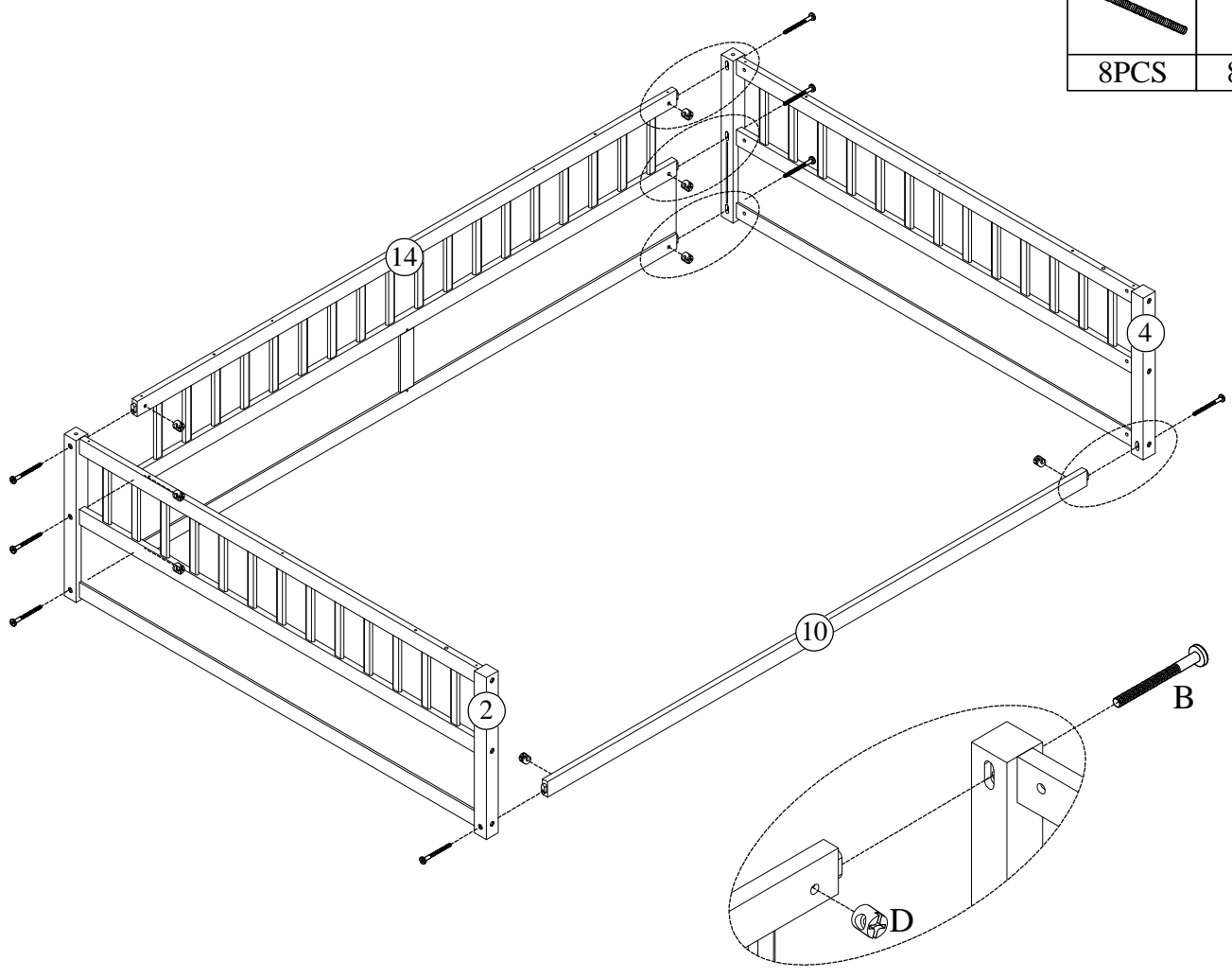

# STEP4:

B	D
	
8PCS	8PCS





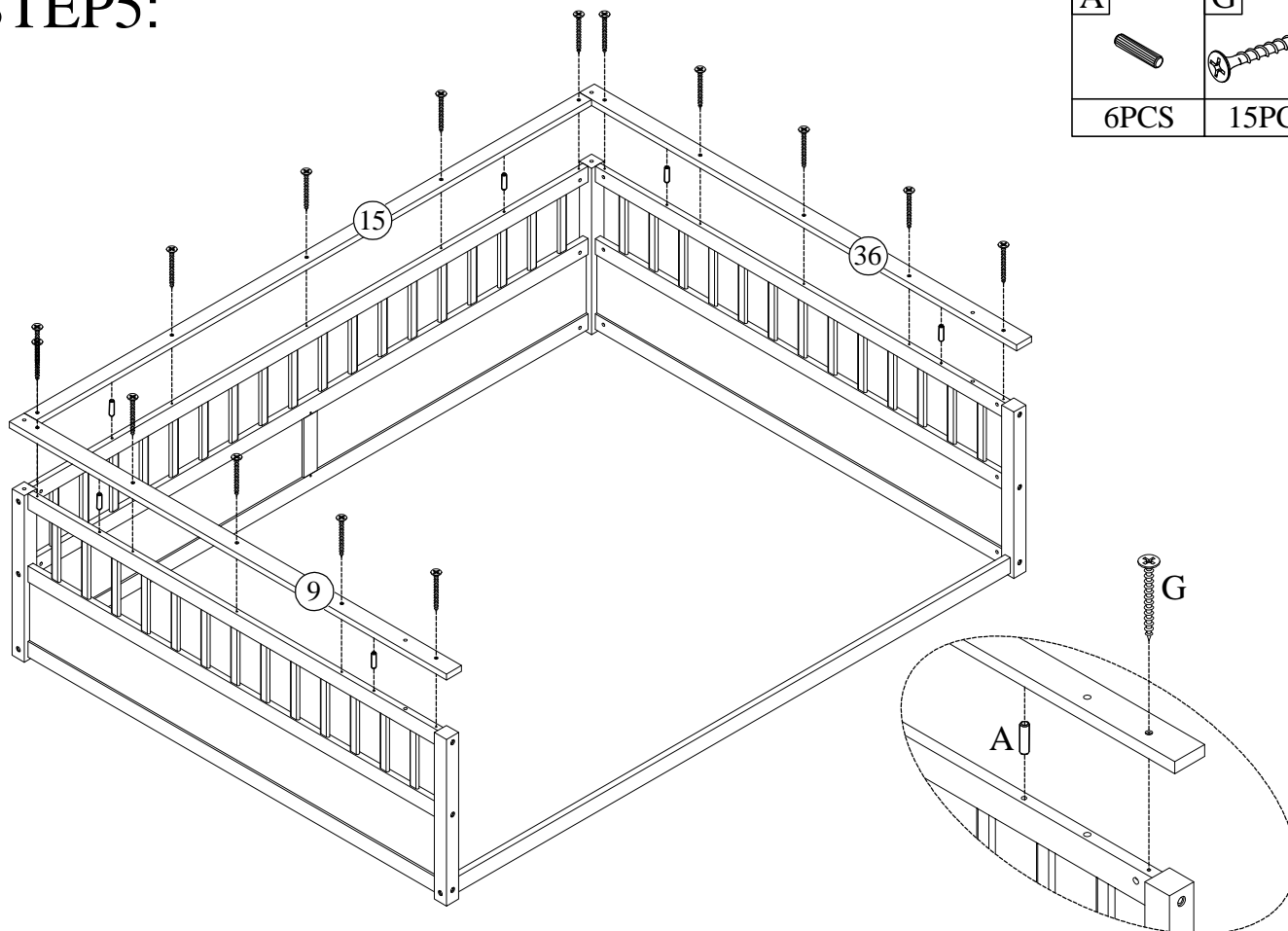

# STEP5:

A	G
	
6PCS	15PCS



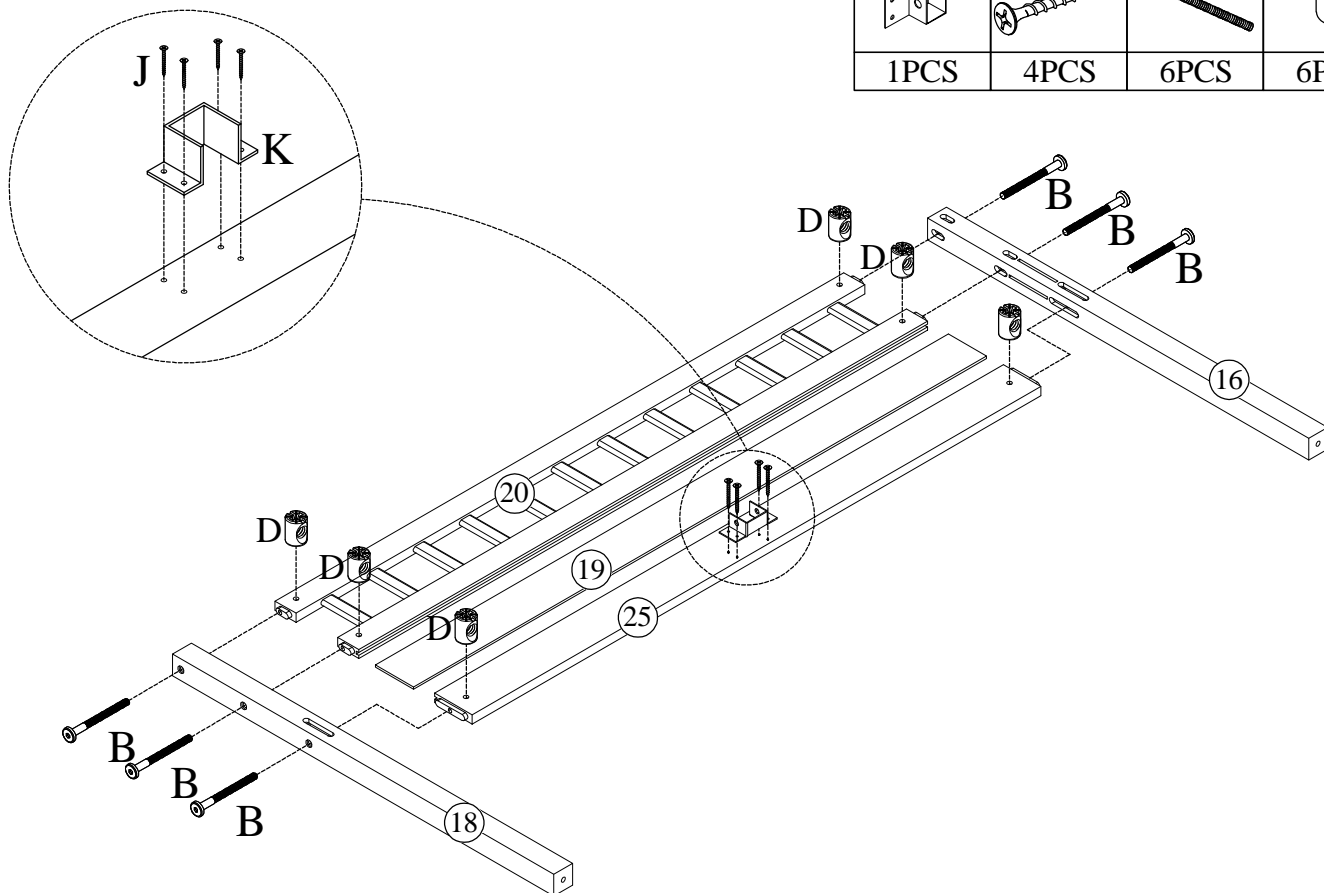

# STEP6:

K	J	B	D
			
1PCS	4PCS	6PCS	6PCS



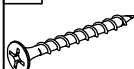
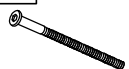

# STEP7:

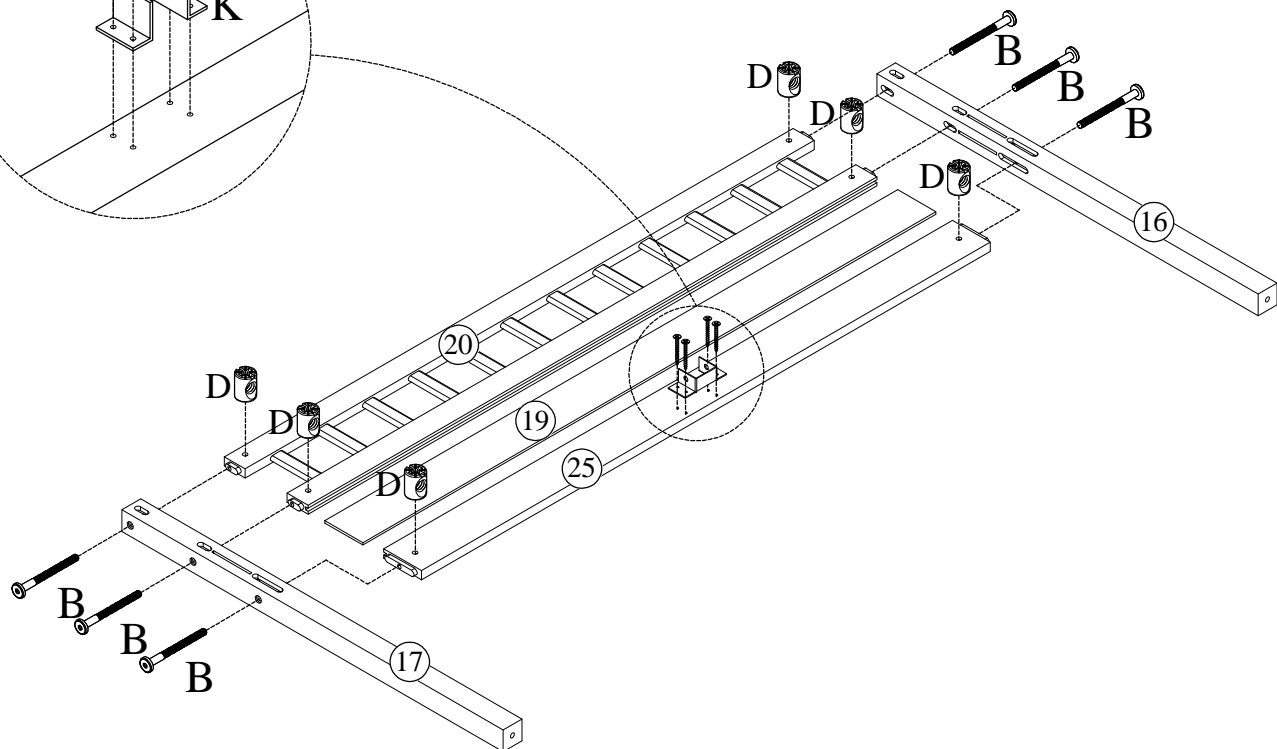
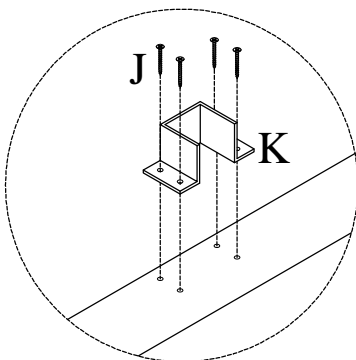
<b>K</b> 	<b>J</b> 	<b>B</b> 	<b>D</b> 
1PCS	4PCS	6PCS	6PCS



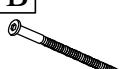

# STEP8:

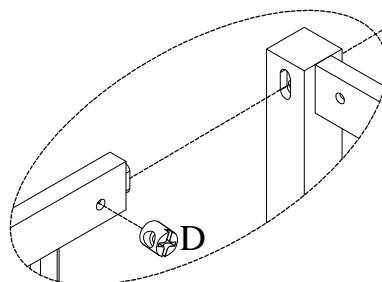
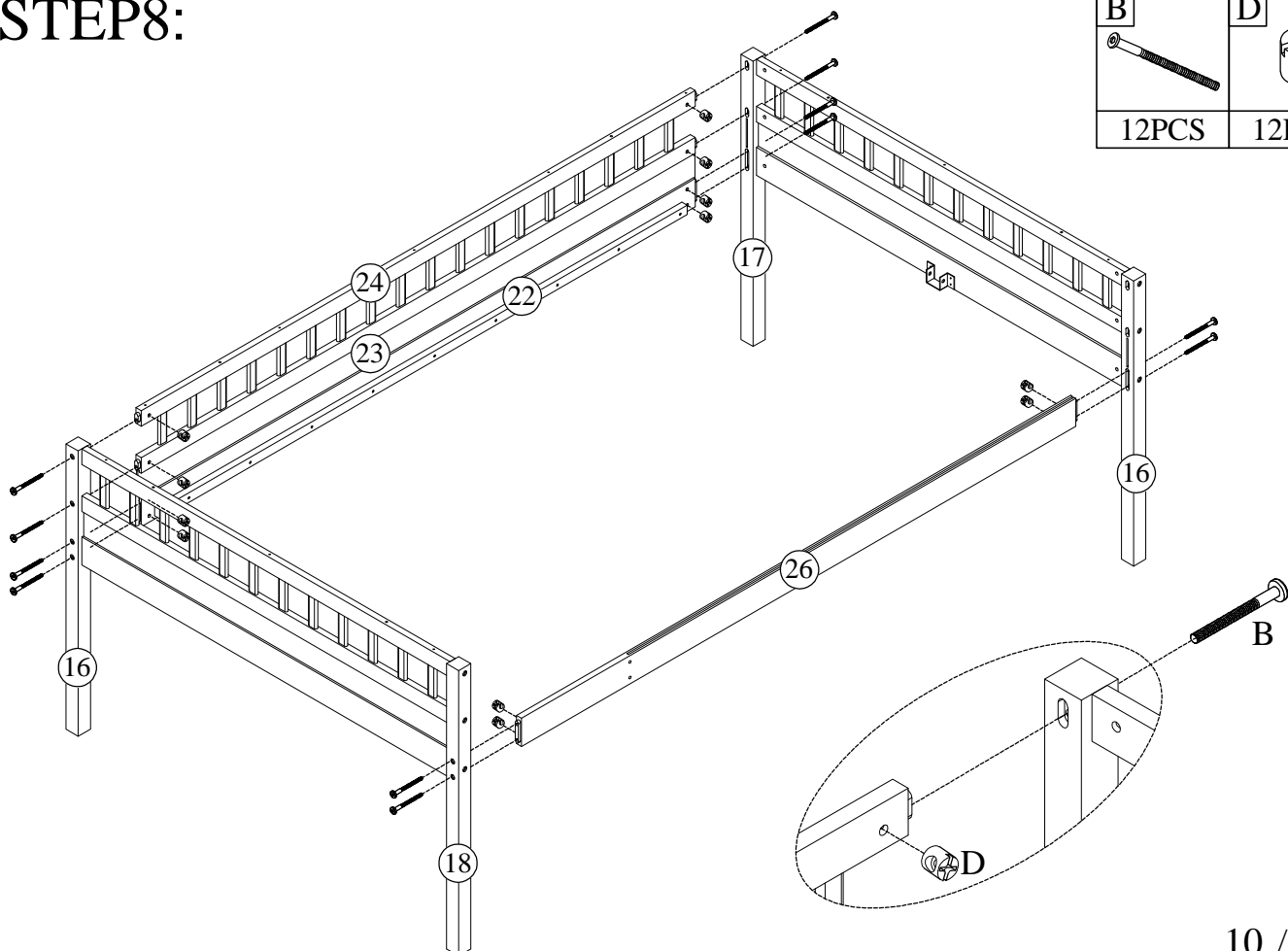
<b>B</b> 	<b>D</b> 
12PCS	12PCS



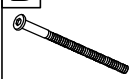

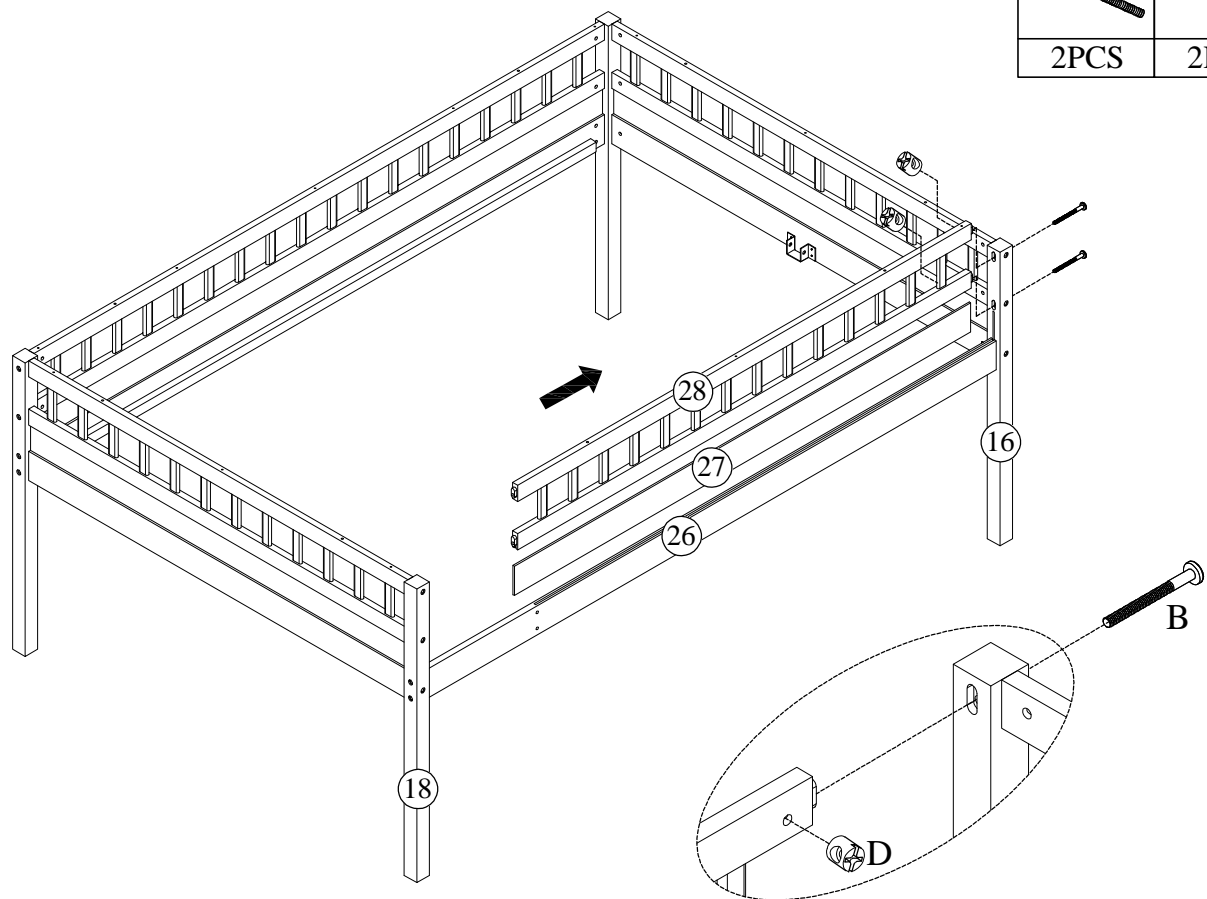

# STEP9:

<b>B</b> 	<b>D</b> 
2PCS	2PCS

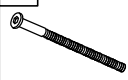

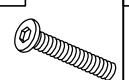

# STEP10:

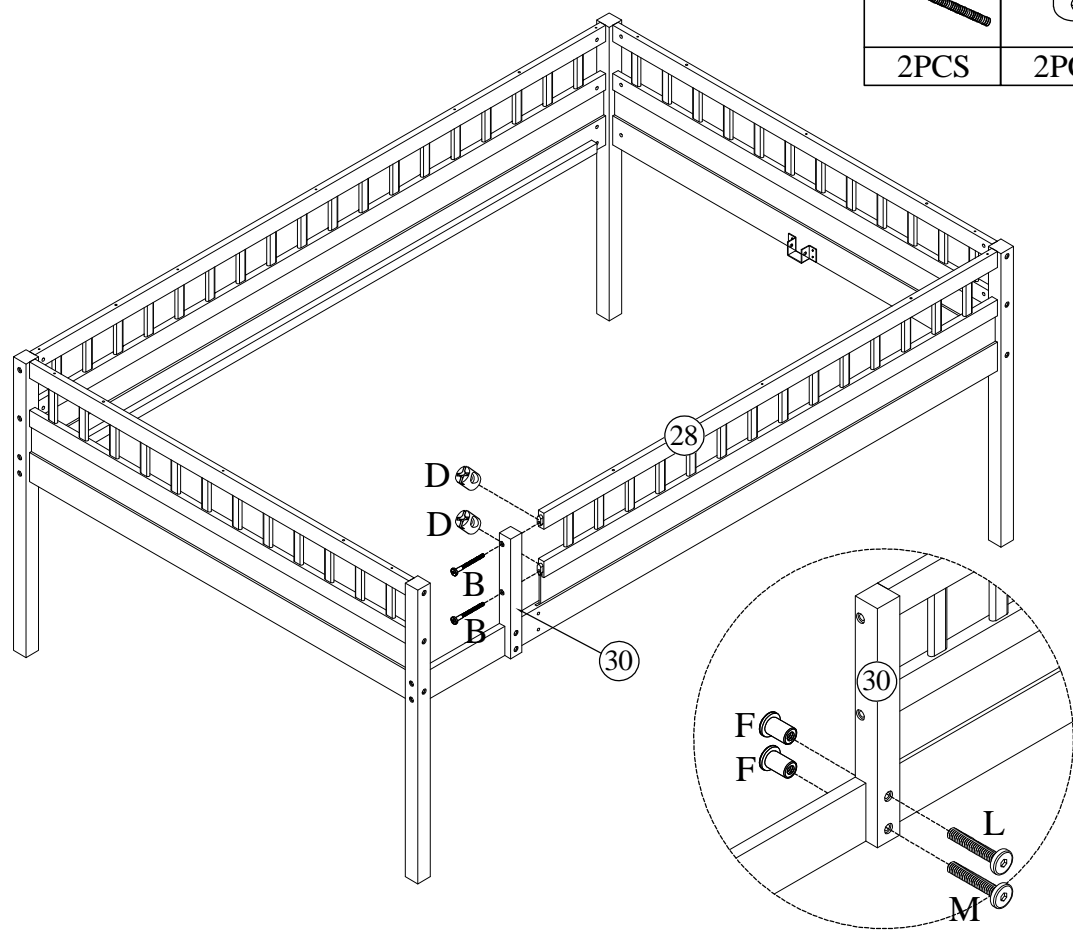
<b>B</b> 	<b>D</b> 	<b>M</b> 	<b>F</b> 
2PCS	2PCS	1PC	2PCS
			<b>L</b> 
			1PC



# STEP 11:

A	G
	
8PCS	20PCS

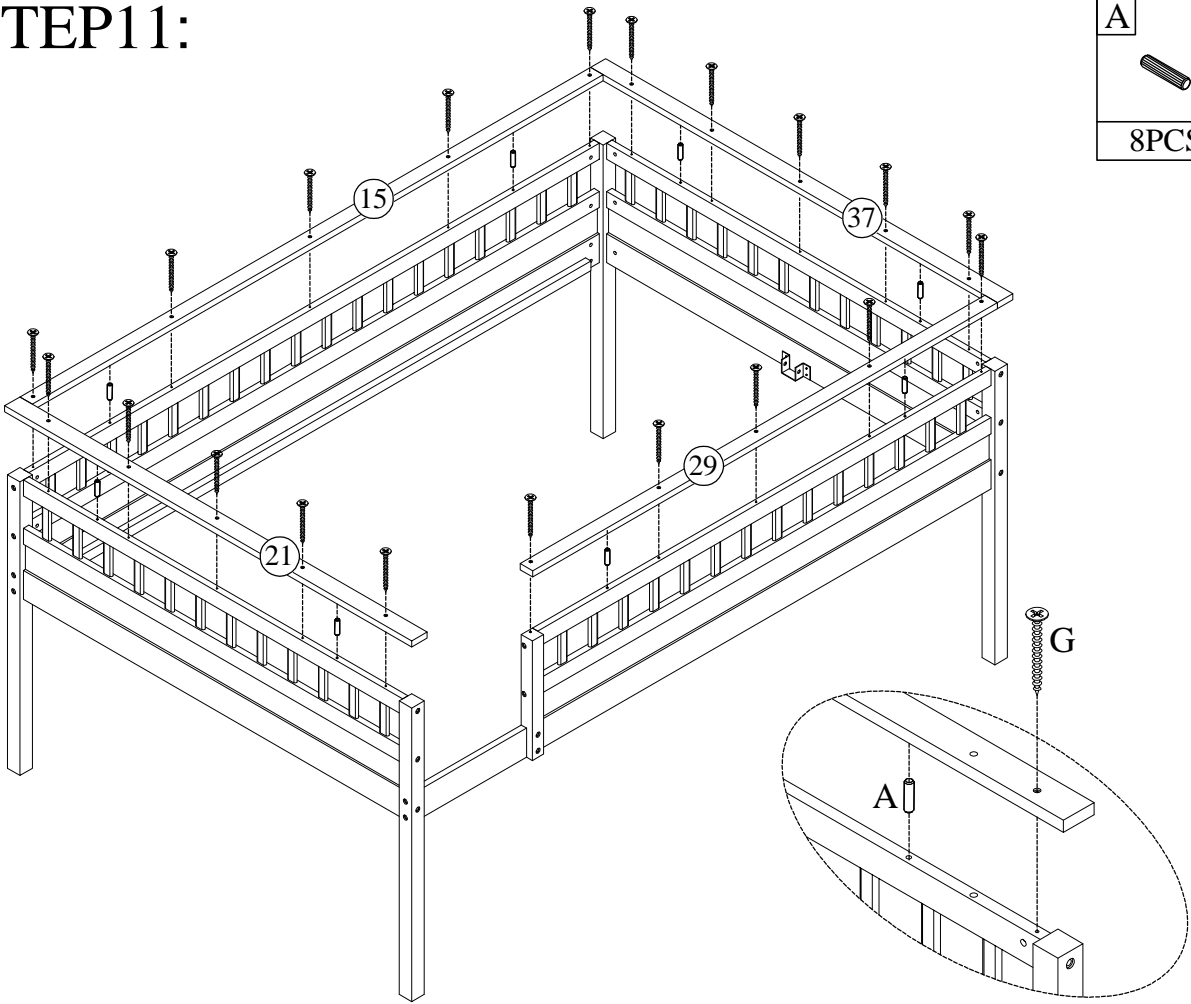

# STEP 12:

P

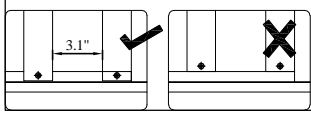
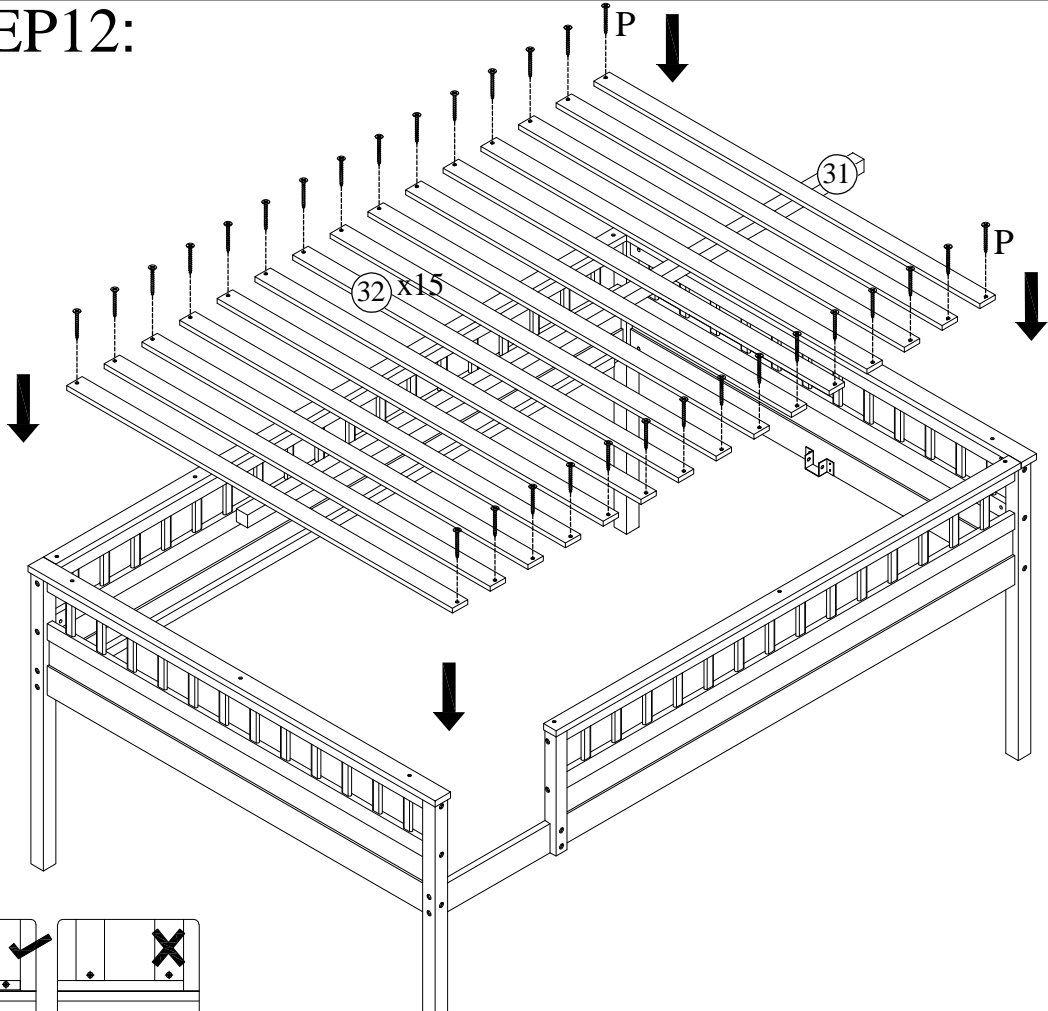
30PCS





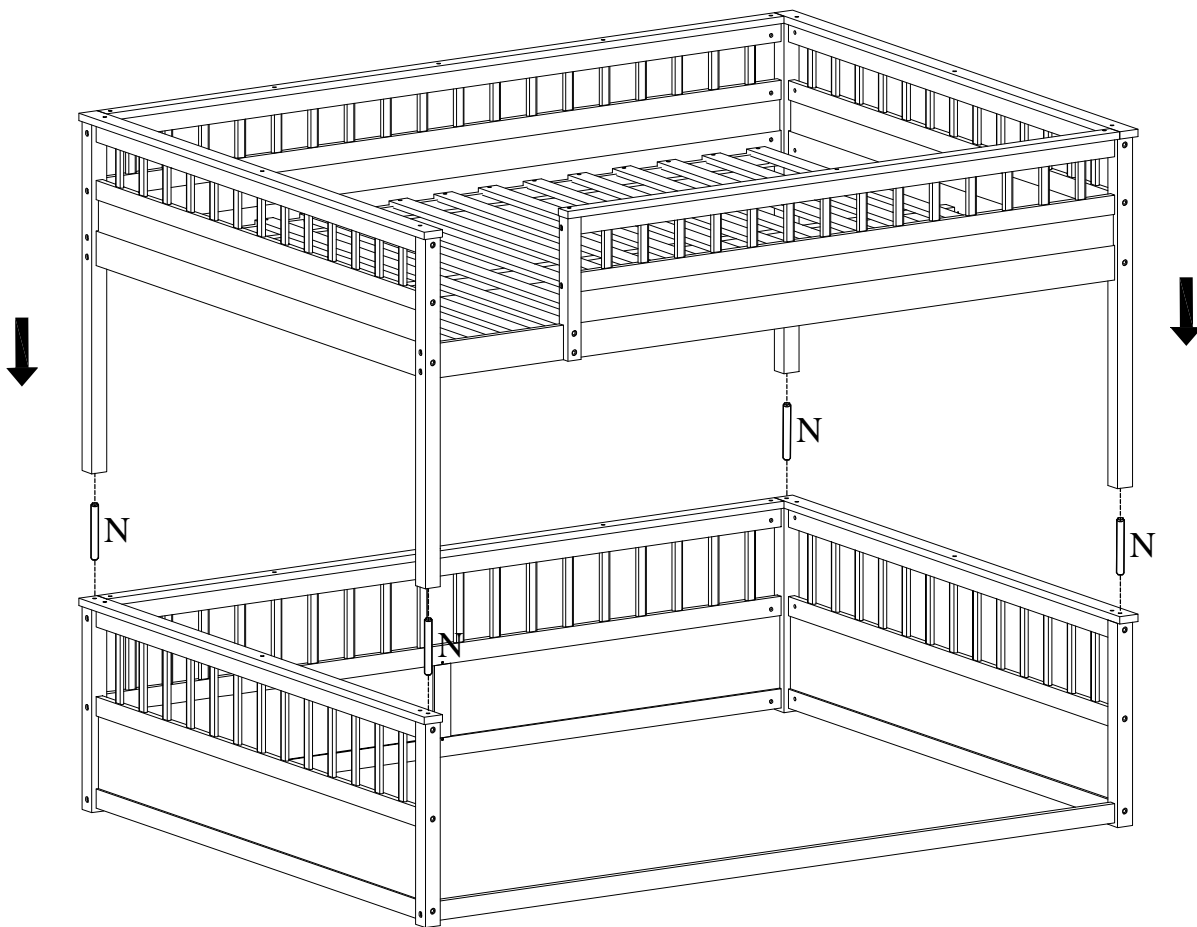

# STEP13:

N	
4PCS	



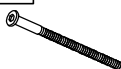

# STEP14:

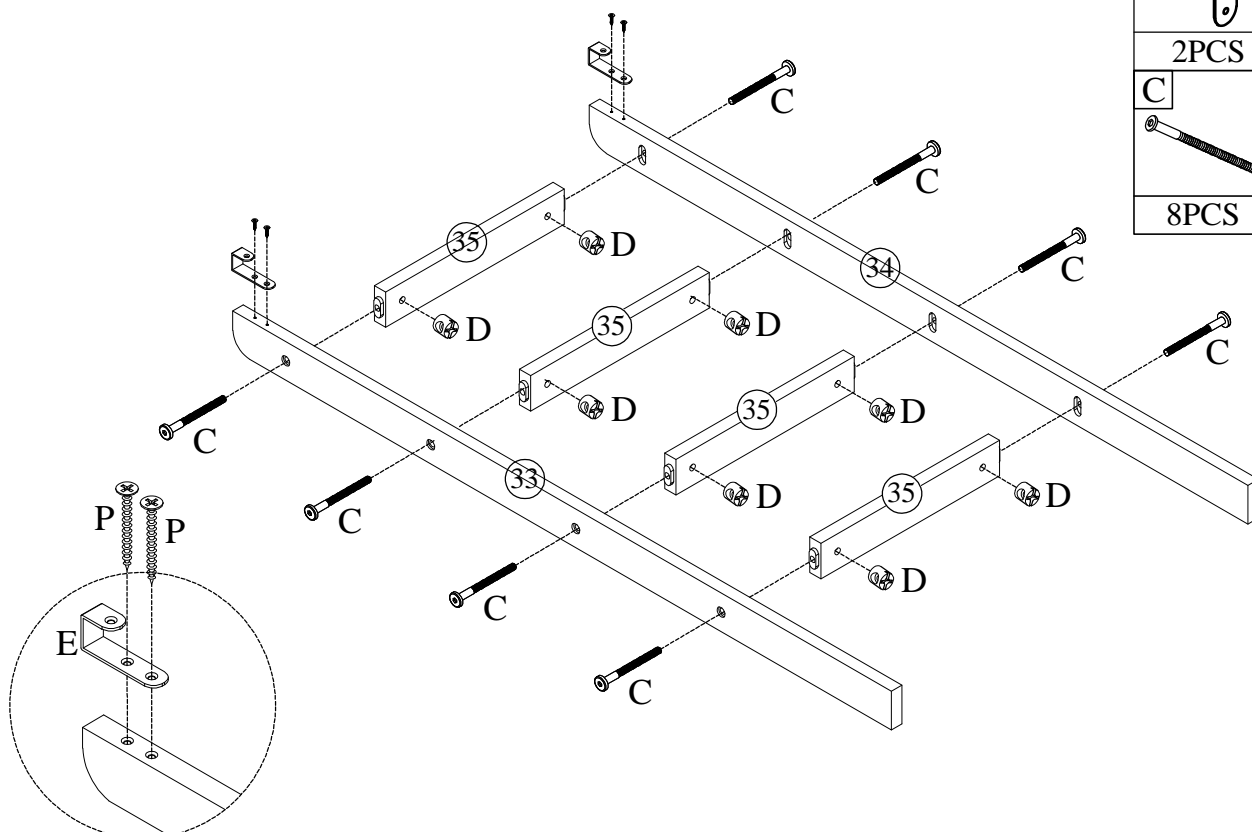
E		P	
2PCS		4PCS	
C		D	
8PCS		8PCS	



# STEP15:

J	O
	
6PCS	2PCS

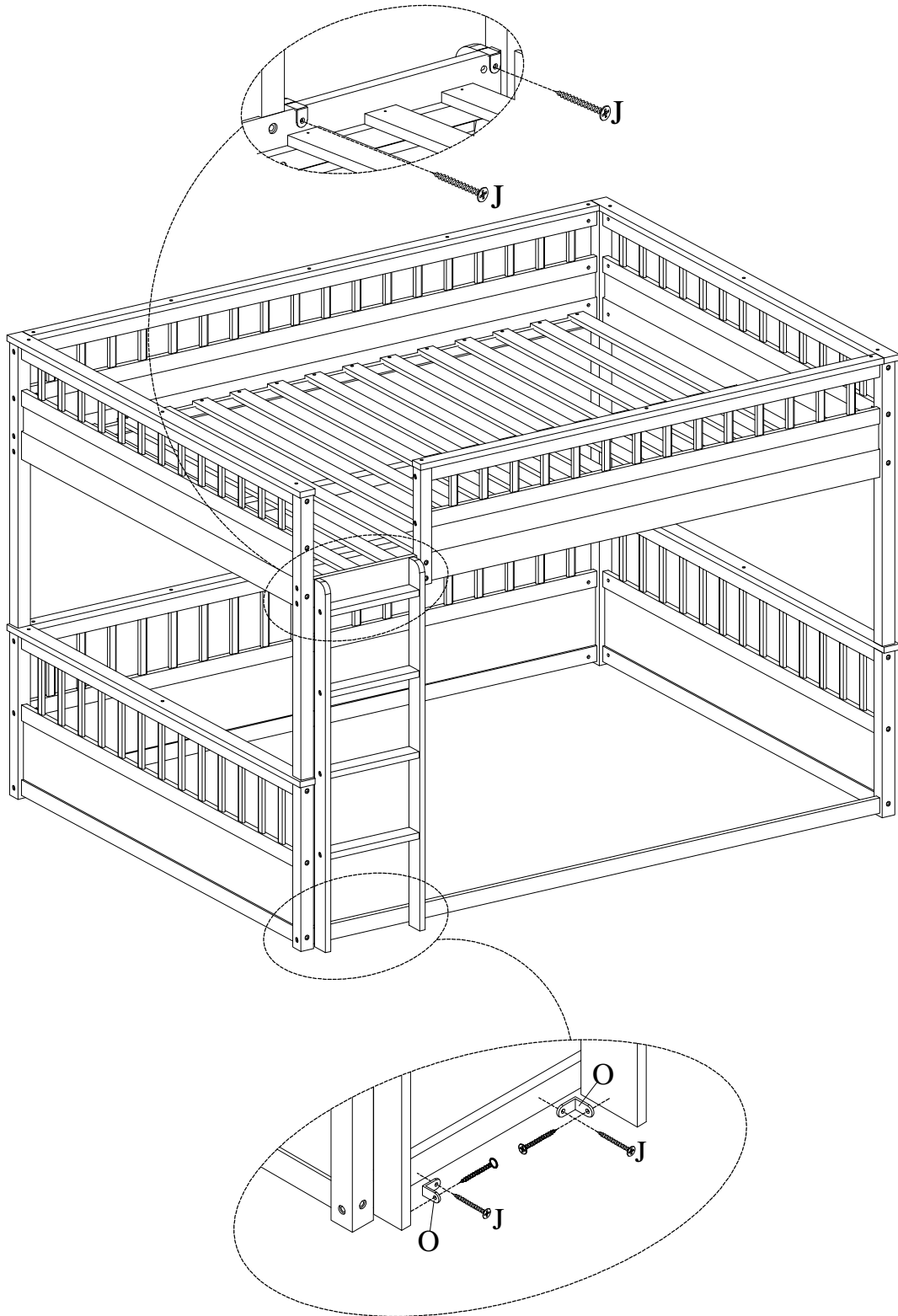

COMPLETED

