

Bed Frame

Assembly Guide

Tip!

DO check for all the components and screws listed in this guide before putting things together.

Return Policy

Your satisfaction is our top priority. If our product fails to satisfy you, please let us know how we can make things right for you.

To be eligible for a full-refund return, the item must be in pristine condition, in the original packaging, with all of the shipped components intact and not yet assembled, and with the item's unique proof of purchase.

Trouble shooting:

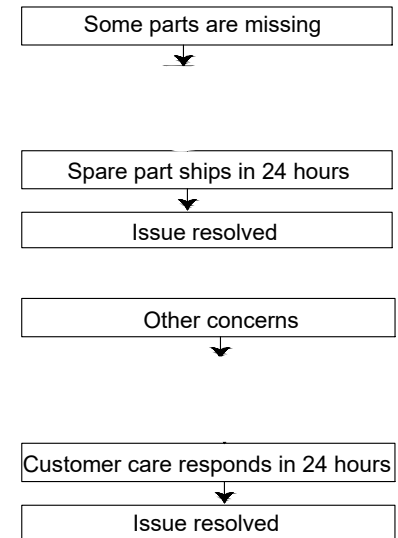

We run our own manufacturer, so rest assured about the quality consistency.

CAUTION!

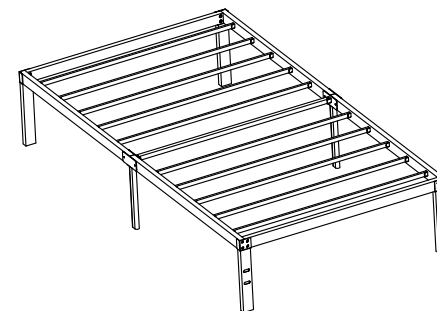



Item Description: Bed Frame

#Number System

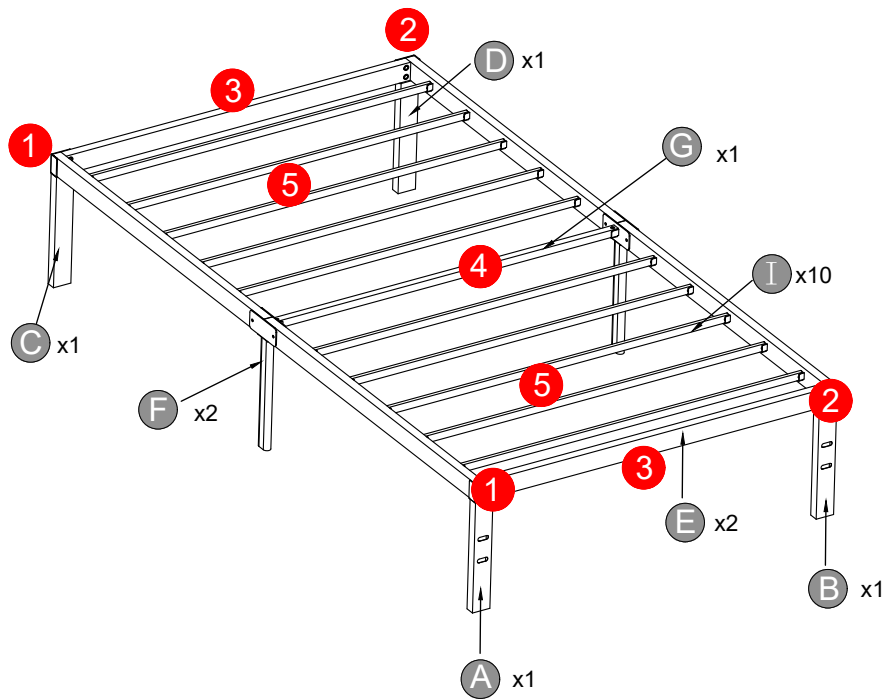
Follow the marked steps for the easiest assembling process
step 1 step 2 step 3 step 4...

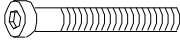
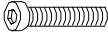

Components					
A		1pc	B		1pc
C		1pc	D		1pc
E		2pcs	F		2pcs
G		1pc	I		10pcs

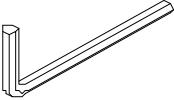
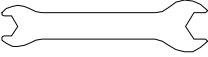

<p>1</p>	 <p>M8x45mm</p>	<p>16pcs</p>	<p>2</p>	 <p>M6x35mm</p>	<p>2pcs</p>
<p>3</p>	 <p>M8</p>	<p>8pcs</p>	<p>4</p>	 <p>Ø8</p>	<p>16pcs</p>
<p>5</p>		<p>1pc</p>	<p>6</p>		<p>1pc</p>

Step 1 Connect F to A and C

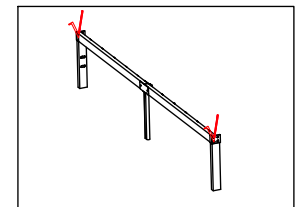
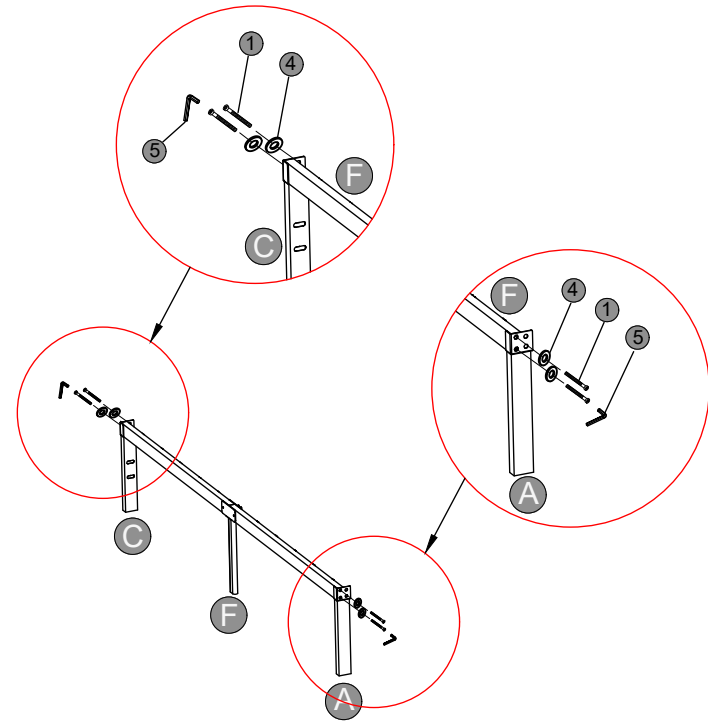
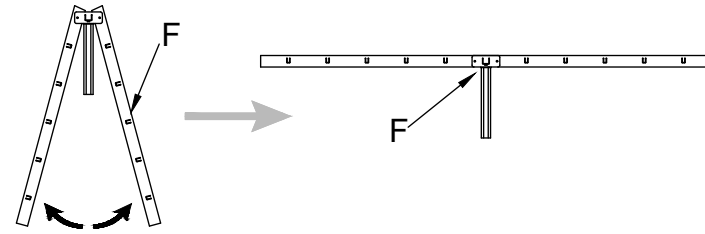
-  1 x4
-  4 x4



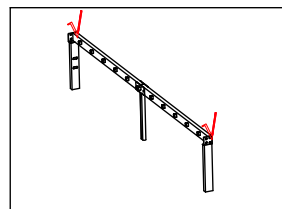
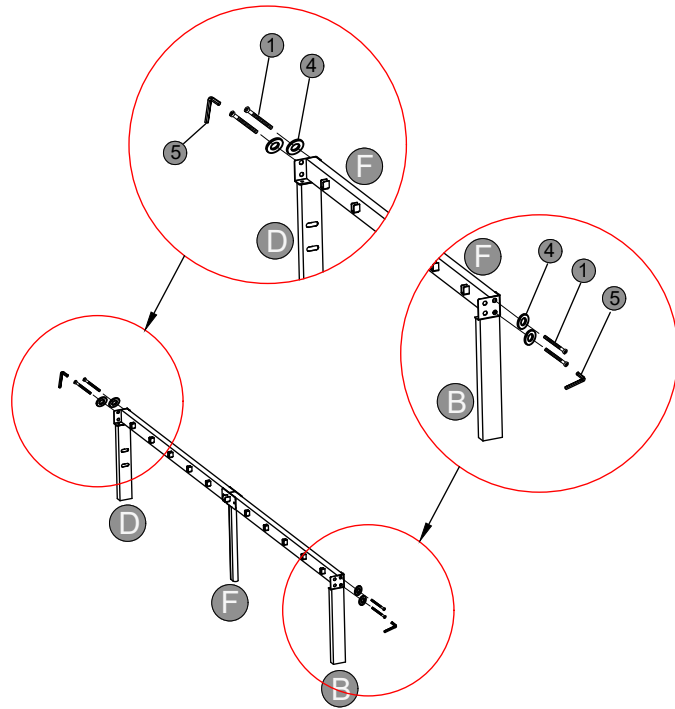
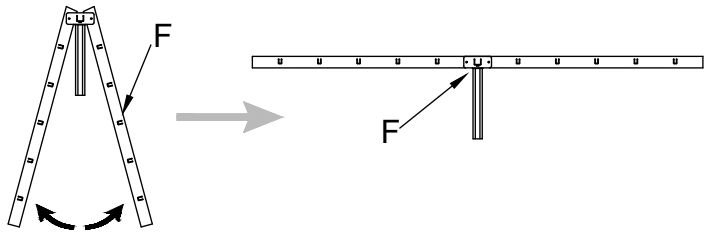

Step 2 Connect **F** to **B** and **D**

	1x4
	4x4



Step 3 Connect **E** to **1** and **2**

	1x8
	3x8
	4x8

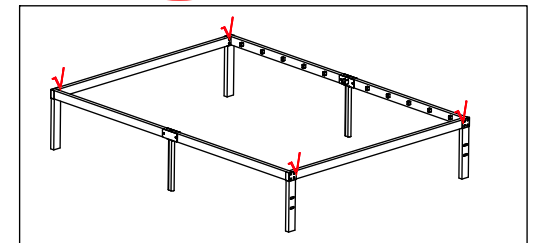
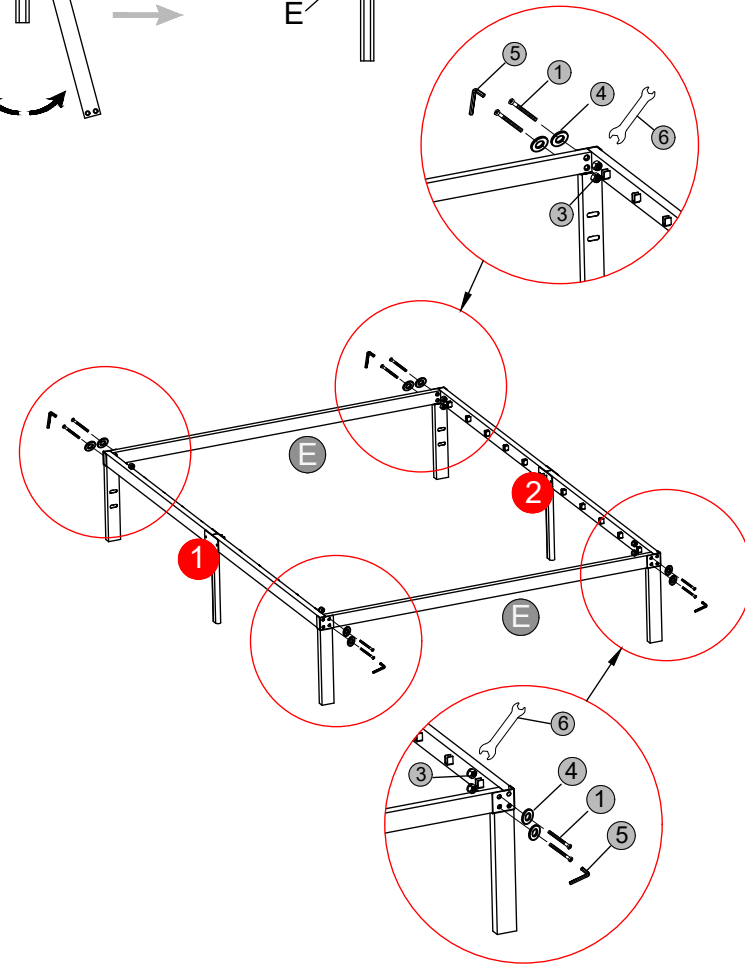
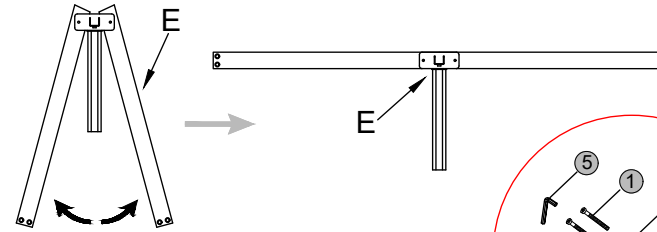

Step 4 Connect **3** to **G**

 **2**x2

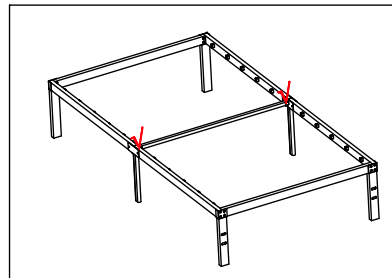
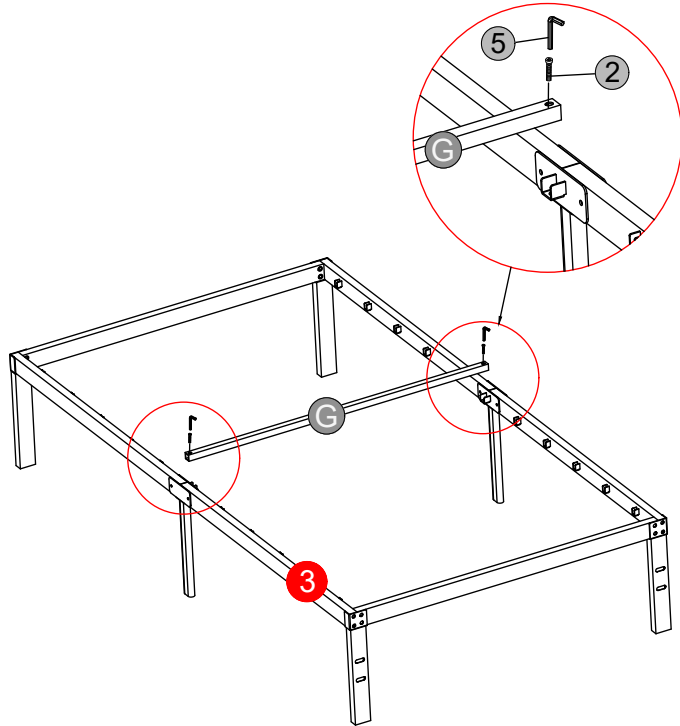

Step 5 Assemble bed slats

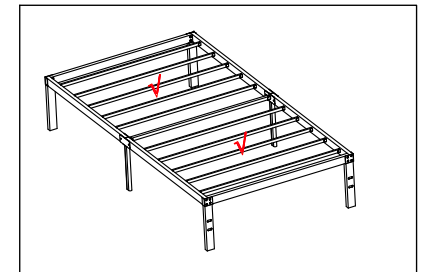
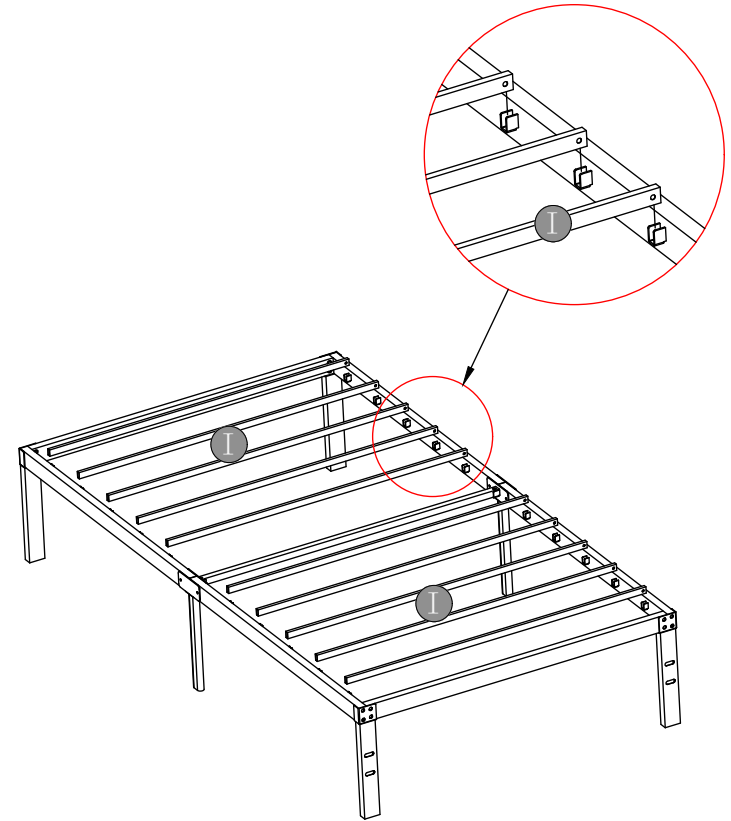

Step 6 Check and tighten all screws

