

# PART LIST

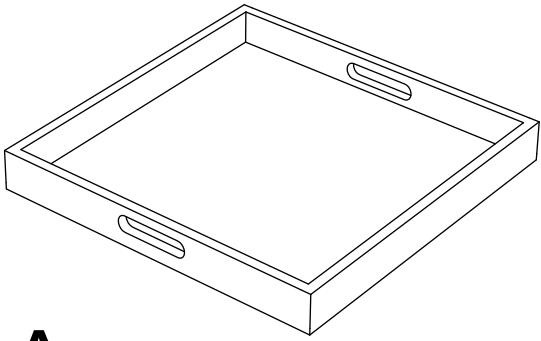

**A** TRAY (1PC)

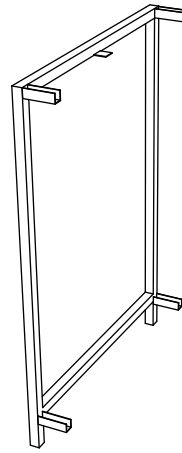

**B** SIDE ASSEMBLY (2PCS)

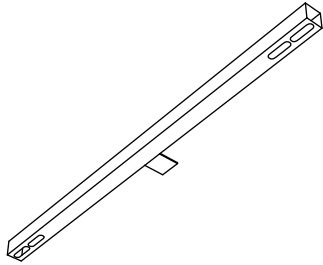

**C** TOP RAIL (2PCS)

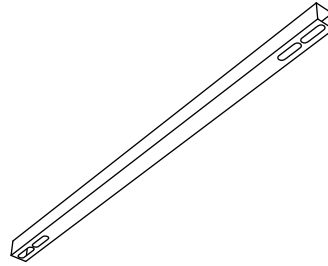

**D** BOTTOM RAIL (2PCS)

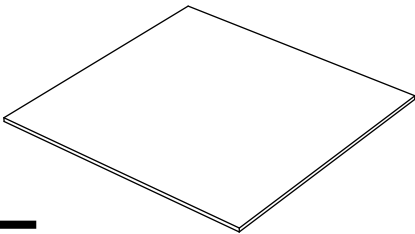

**E** TOP GLASS (1PC)

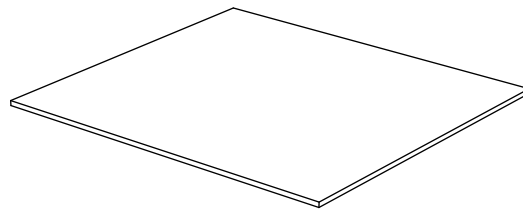

**F** BOTTOM GLASS (1PC)

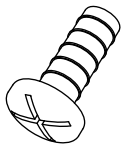

**G** SCREWS (16PCS)



**H** NON-SLIP DISK (8PCS)

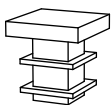

**I** PLASTIC FOOT (4PCS)