

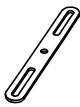
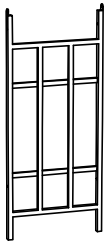
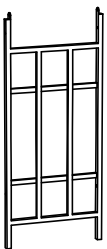
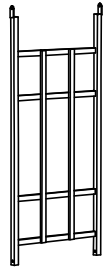
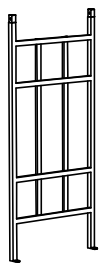
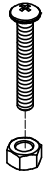

ASSEMBLY INSTRUCTIONS

<p>1</p>  <p>4pcs</p>	<p>2</p>  <p>1pc</p>	<p>3</p>  <p>1pc</p>	<p>4</p>  <p>2pcs</p>	<p>A</p>  <p>2pcs</p>	
<p>a</p>  <p>M6*35mm</p> <p>6pcs</p>	<p>b</p>  <p>M6*30mm</p> <p>8pcs</p>	<p>c</p>  <p>4pcs</p>	 <p>1pc</p>	 <p>1pc</p>	

<p>1</p> <p>a x2</p>  <p>Tighten the screws to 50% tightness</p> 	<p>2</p> <p>a x4</p>  <p>Tighten the screws to 50% tightness</p> 
<p>3</p> <p>b x4</p>  <p>Adjust the balance and width you need, then tighten all screws to 100% tightness</p>	<p>4</p> <p>b x4</p> 

5

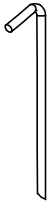
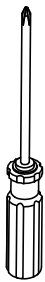
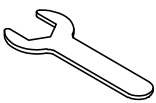
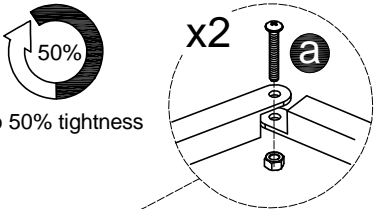
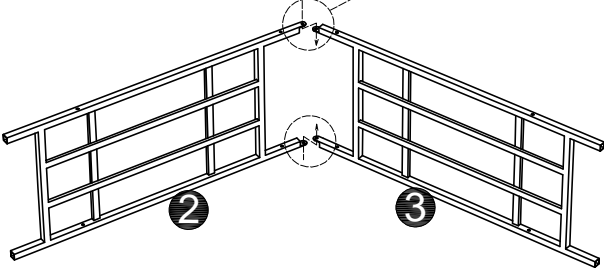
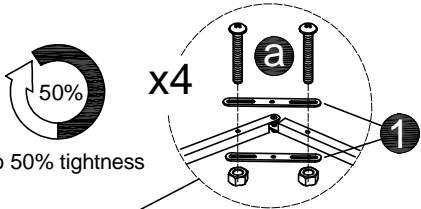
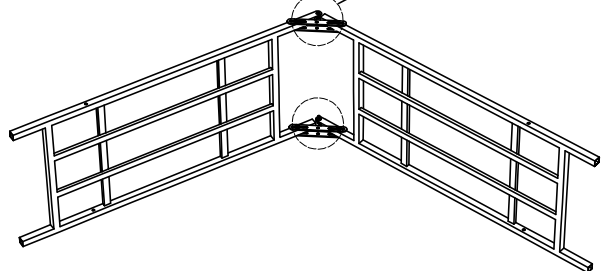
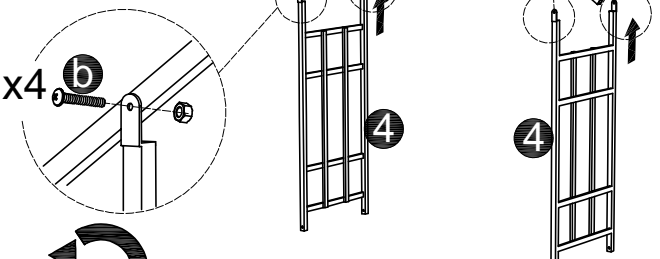
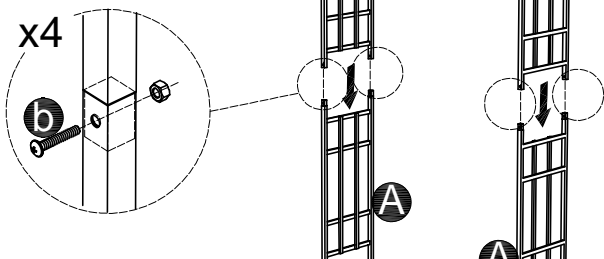
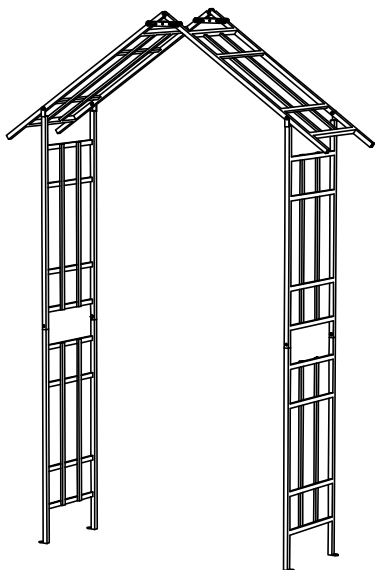

Tighten all screws to 100% tightness

6

C x4

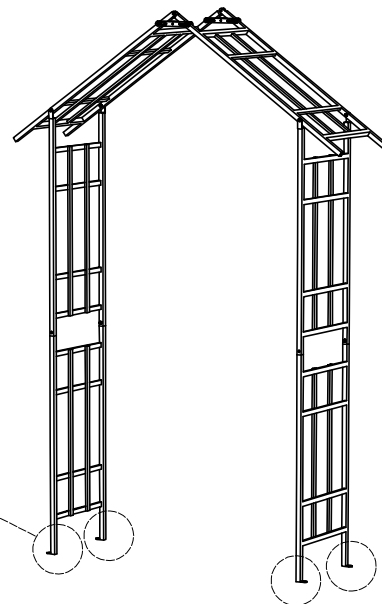

Option-1

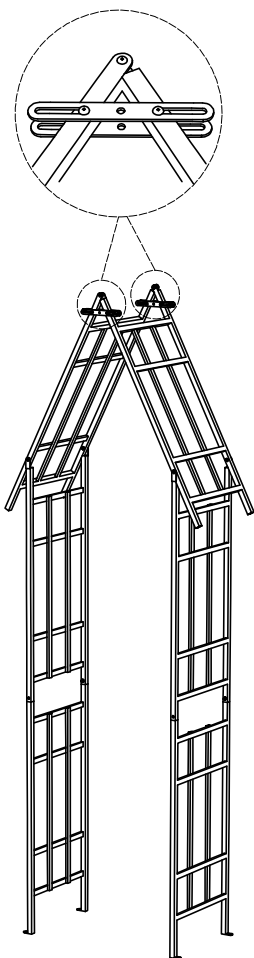

Option-2

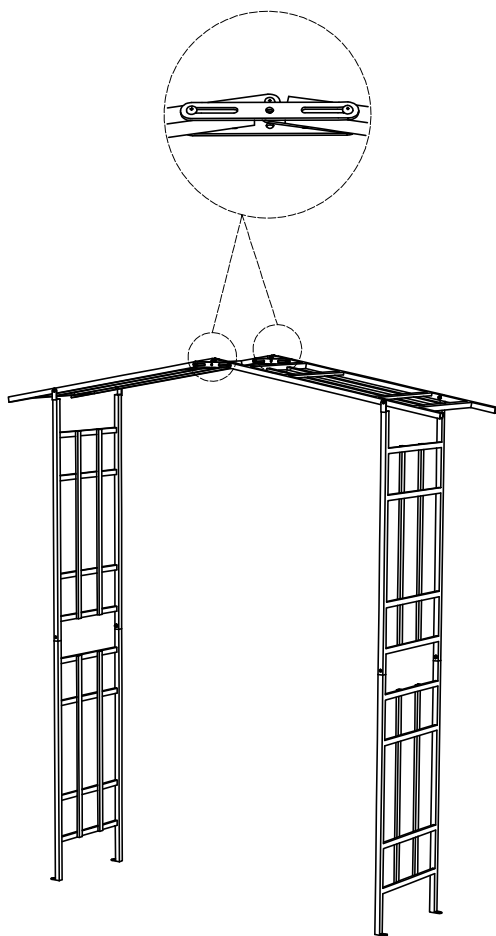

Option-3

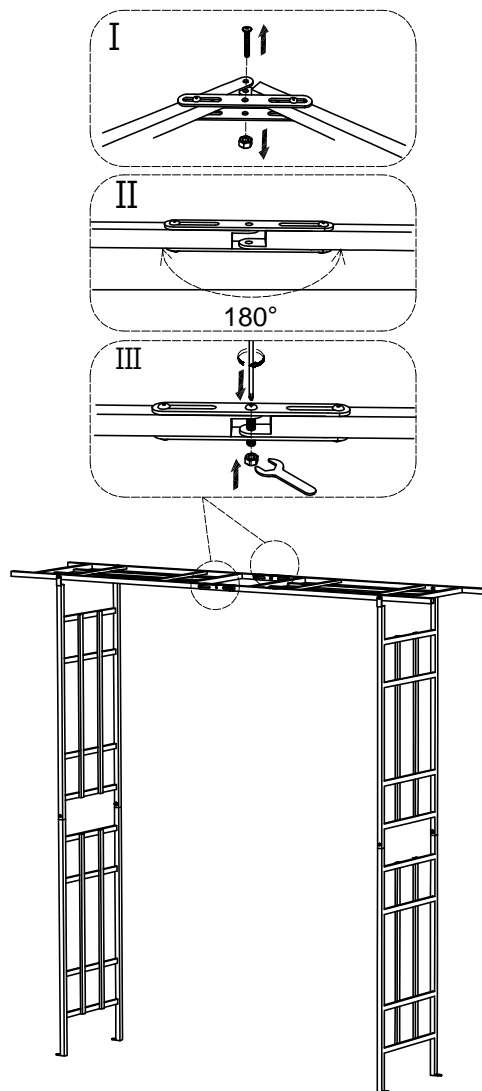

The width of the Arch can be freely adjusted through the top flat iron. Channel widths range from 34.3" to 60.4".