

WARRANTY

We're committed to designing beautiful modern furniture that complements a variety of décor styles and tastes using the highest quality materials and fabrics. Our Manufacturer's warranty covers defects in materials and workmanship for 30days from the products date of delivery. Please email us your order No and contact information to located your order if you need any help.

Are you having difficulty with assembly? Missing parts?

For return, Please check the return policy with the retailer or MarketPlace you bought from.

**Appreciated your purchasing from us.
Pop up your life by our furniture piece!**

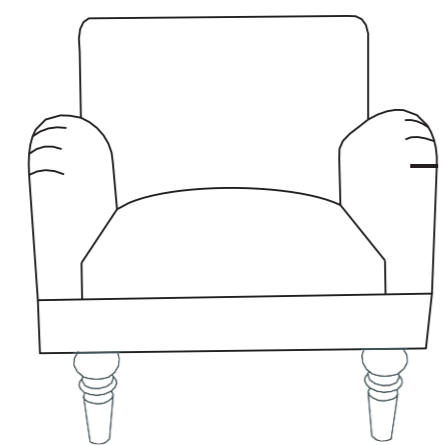

NOTE:

This brochure contains IMPORTANT safety info. Please read and keep for future reference.

8

1

MAINTAINANCE AND WARNING

- Keep furniture away from heat.
- Do not clean furniture with harsh cleansers or polish. Do not use detergents, Solvents, abrasives, spray packs or leather cleaner. Use non-color mild soap with warm water clean spills(Mix 1:10 soap to water)
- Do not place furniture under direct sunlight, material will possibly fade overtime.
- Do not use on site dry Cleaning machine.
- Children should not climb or jump on the furniture.
- Do not write on furniture without a padded barrier to protect the surface.
- Not for commercial use, For residential use only.

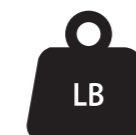

Weight Limitation
220LBS

2

PARTS LIST

A*1

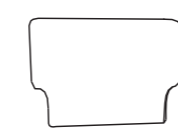

B*2

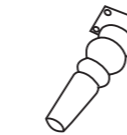

C*1



D*1



E*1



3

HARDWARE LIST

F * 14

M6*25mm



G*1



SPARE

F*1



Be sure to check all packing material carefully for small parts, which may have come loose inside the carton during shipment.

4

ASSEMBLY INSTRUCTIONS

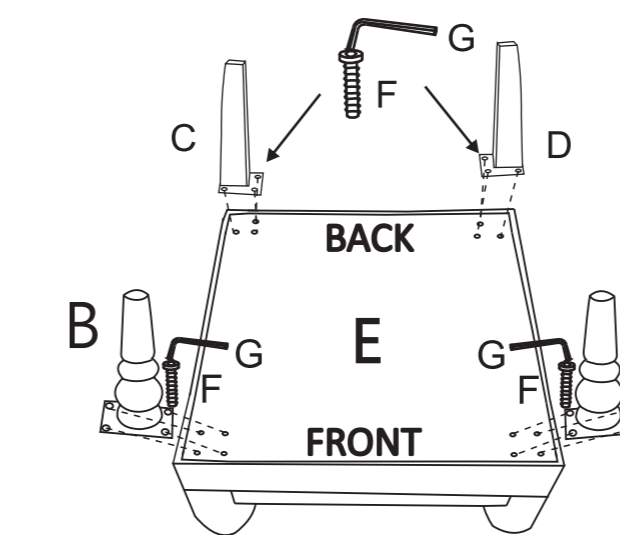
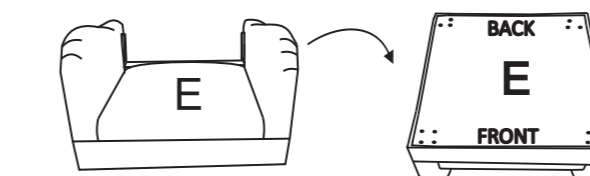

STEP 1 : Place seat E upside down on clean padded surface. Use bolt F, allen key G to attach legs B/C/D to bottom of the seat E, make sure all parts align then fasten all bolts to secure.

5

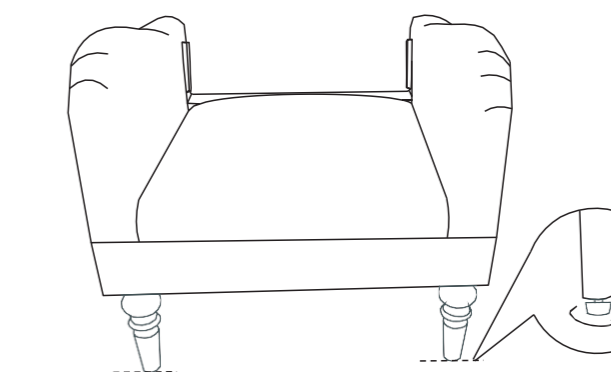

STEP2 : Adjust the levelers to set the whole chair leveled.

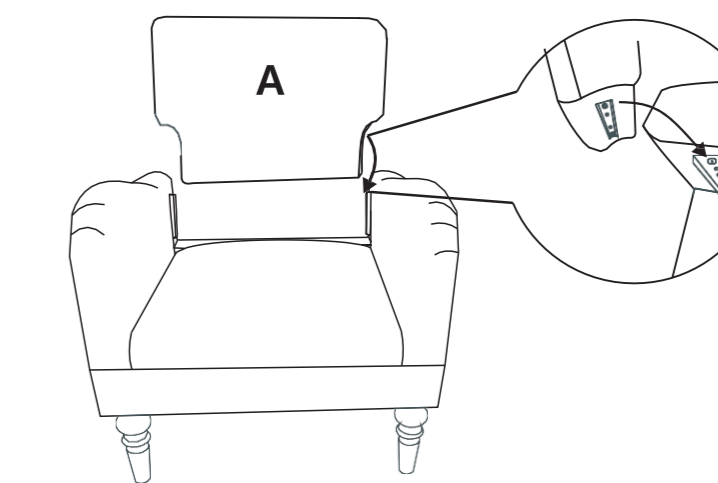

STEP3 : Align male and female metal bracket then insert backrest A and push it all the way down to secure.

6

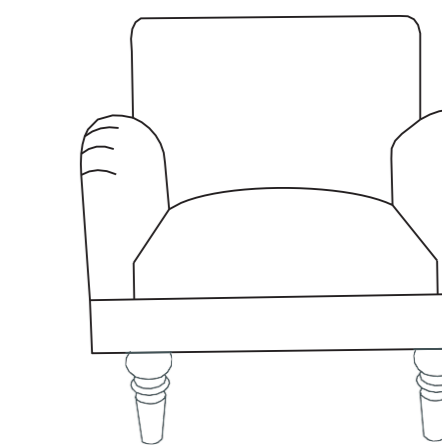

STEP4 : Assembly completed

7