

ASSEMBLY INSTRUCTION

Ax1

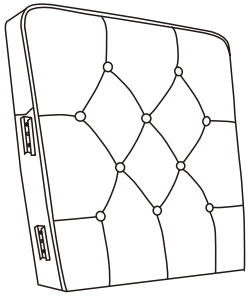

Bx1

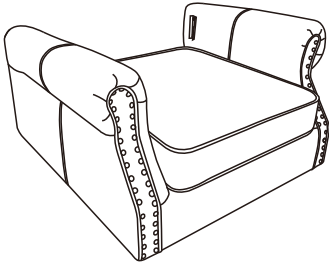

Cx1

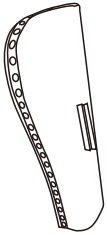

Dx1

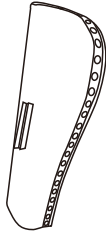

Ex2

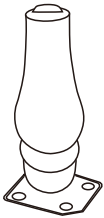

Fx2

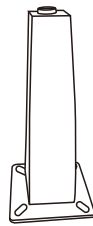

Gx12

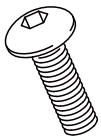

Hx2

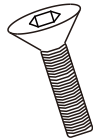

Ix1



①

FRONT

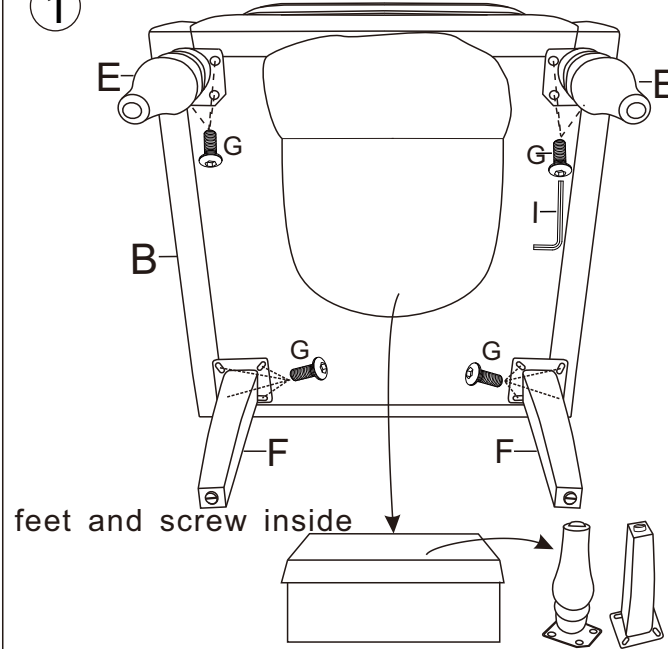

③

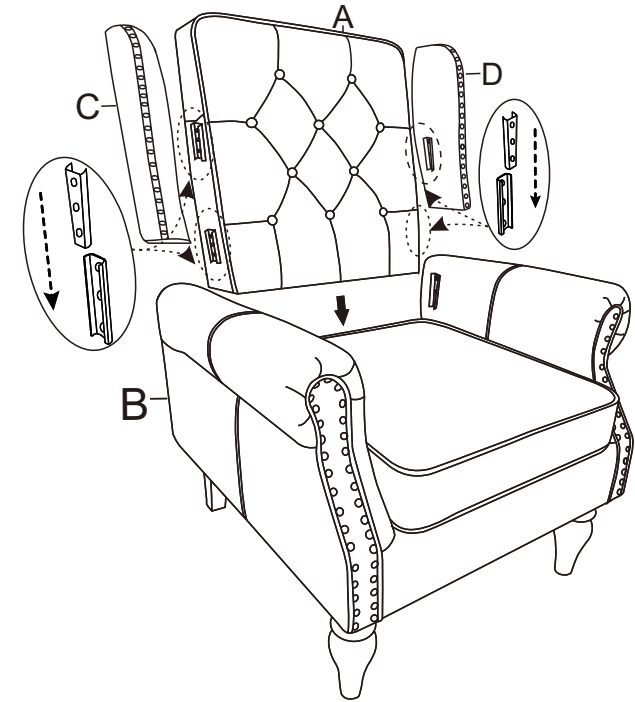

②

