

edishinē

Ceiling Fan With Light

SKU: HCFM04A

[Instruction Manual]

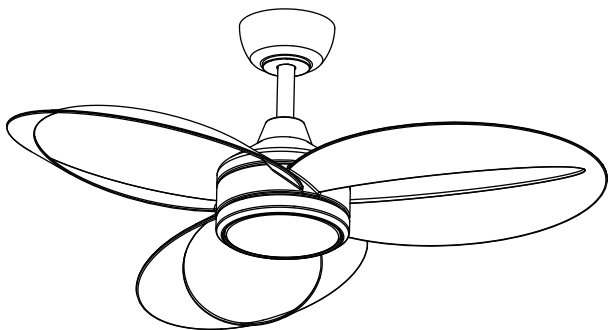

Please pay attention to the warning signs
Read the instructions with caution before operating
and keep it properly

CAUTIONS AND WARNINGS

READ THIS ENTIRE MANUAL CAREFULLY BEFORE BEGINNING INSTALLATION. SAVE THESE INSTRUCTIONS.

Use only edishine replacement parts.

1. To reduce the risk of personal injury, attach the fan directly to the support structure of the building according to these instructions, and use only the hardware supplied.
2. To avoid possible electrical shock, Disconnect the power by turning off the circuit breakers to the outlet box and associated wall switch before installing your fan location. If you cannot lock the circuit breakers in the off position, securely fasten a prominent warning device, such as a tag, to the service panel.
3. All wiring must be in accordance with national and local electrical codes and ANSI/NFPA 70. If you are unfamiliar with wiring, use a qualified electrician.
4. To reduce the risk of personal injury, do not bend the blade attachment system when installing, balancing, or cleaning the fan. Never insert foreign objects between rotating fan blades.
5. To reduce the risk of fire, electrical shock, or motor damage, do not use a solid-state speed control with this fan, Use only our speed controls.

NOTE: The important safety precautions and instructions appearing in the manual are not meant to cover all possible conditions and situations that may occur. It must be understood that common sense and caution are necessary factors in the installation and operation of this fan.

Parts Inventory





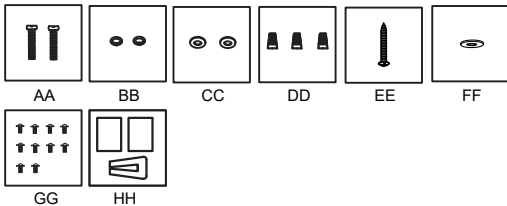



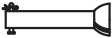
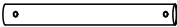

Carefully open the package. Remove items from styrofoam inserts. Remove motor housing and place on carpet or styrofoam to avoid damage to finish. Check again parts list that all parts have been included.

Hardware Included

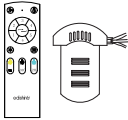

AA	Mounting bracket screws	2
BB	Spring washers	2
CC	Flat washers	2
DD	Plastic wire nuts	3
EE	Cable screw	1
FF	Flat washer	1
GG	Blade screws	10
HH	Balancing kit	1

Package contents

								
A	Mounting bracket	1	B	Canopy	1	C	Canopy cover	1
								
D	6" Downrod	1	E	10" Downrod	1	F	Coupling cover	1
								
G	Motor cover	1	H	Motor	1	I	Remote control	1
								
J	Light kit	1	K	Light cover	1	L	Blade	3

MOUNTING BRACKET ASSEMBLING

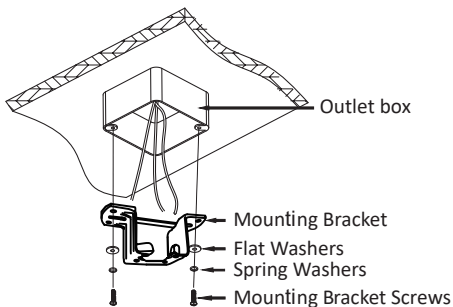

Warning: Failure to disconnect power supply prior to installation may result in serious injury. For safety and best operating results, recommend you have a qualified electrician install this fan.

Secure mounting bracket to outlet box by tightening mounting screws & washers.

The ceiling fan must be installed in a location with a minimum of 300mm spacing from the tip of the blade to the nearest objects or walls. Secure the mounting bracket to the ceiling joist or structure that is capable of carrying a load of at least 15.9kgs, with two long screws provided. Ensure at least 30mm of the screws is threaded into the support.

Note: For ease of wiring feed house wires through mounting bracket.

MOTOR COVER ASSEMBLING

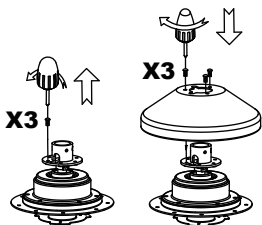

Remove 3 screws from motor, and then install motor cover to motor with 3 screws.

DOWNROD / BALL ASSEMBLING

①

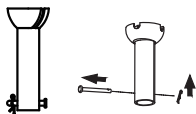

②



③

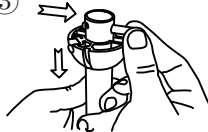

④

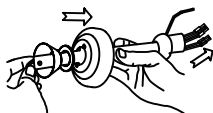

⑤



⑥

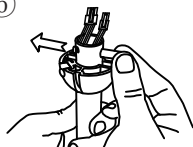

⑦

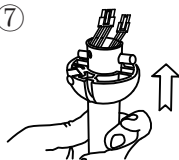

⑧

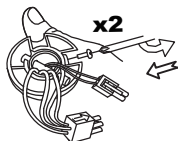

⑨

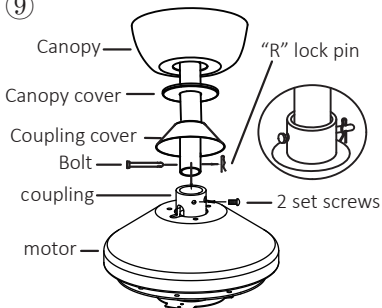

Remove the "R" lock pin,bolt and 2 set screws from the downrod and then take down the hanger ball.

Slide the canopy onto the downrod, followed by the canopy cover and coupling cover.

Feed the motor wire plugs up through the inside of the downrod, then tighten the 2 set screws for hanger ball firmly.

Insert the downrod into the coupling. Gently push the bolt through the holes aligned with the base of the coupling and downrod. Insert "R" lock pin into bolt and secure downrod with 2 set screws.

CAUTION: DO NOT force the bolt. Gently wiggle and rotate it until it glides through both holes.

BLADES ASSEMBLING

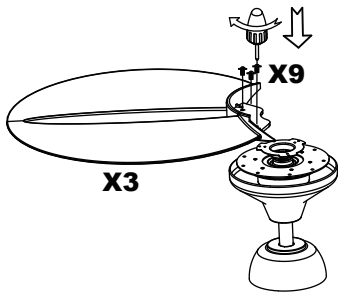

One blade at a time, align the blade with the 3 holes in the motor.
Tighten screws securely.

LIGHT KIT ASSEMBLING

①

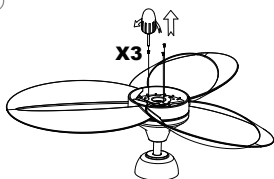

②

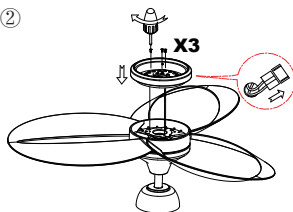

③

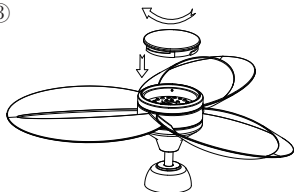

Remove 3 screws from the motor.

Insert the motor plug into the LED board slot, and then install the light kit to motor with 3 screws.

Align groove in the light cover with ridge in the light kit. Twist light cover clockwise until it is secure.

HANG THE FAN INTO MOUNTING BRACKET

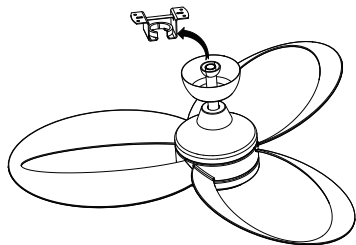

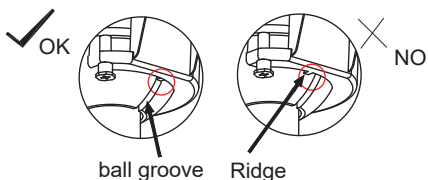

align ball groove on hanger ball with ridge on hanger bracket.
Ensure hanger ball sitting into hanger bracket correctly.
If fan doesnot sit properly,hold the downrod and twist it until fan
has been secured into hanger bracket.

WARNING: Failure to align ball groove with ridge may result in serious injury.

CABLE ASSEMBLING

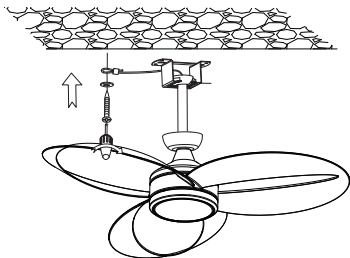

Install the cable to the ceiling with screw and washer provided.

MAKE ELECTRICAL CONNECTIONS

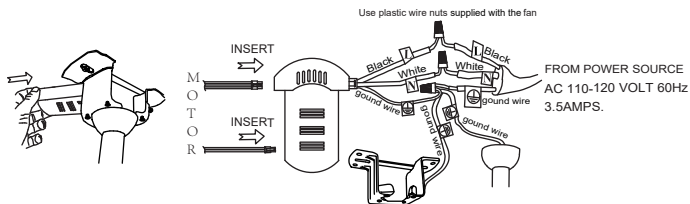

WARNING: To avoid possible electrical shock, be sure electricity is turned off at the main fuse box before wiring.

Insert the receiver into the mounting bracket with the flat side of the receiver facing the ceiling.

Make the wire connection between the Fan and power supply. Make sure all connections are secured.

CANOPY AND CANOPY COVER ASSEMBLING

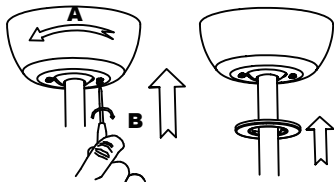

Slide the canopy up to ceiling and align the keyhole slots on the canopy with the 2 preassembled screws on the hanger bracket.

Twist clockwise until it locks. Tighten two screws to fix the canopy securely.

Attach the canopy cover to secure it onto the canopy

size of product

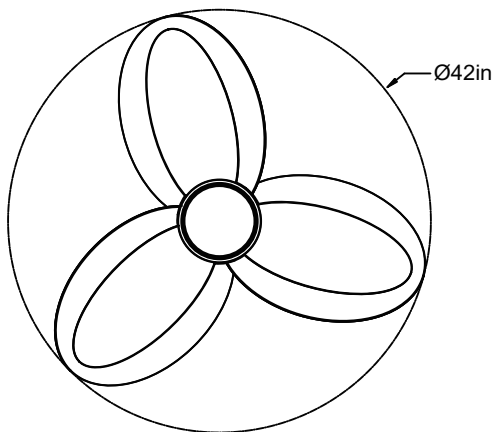
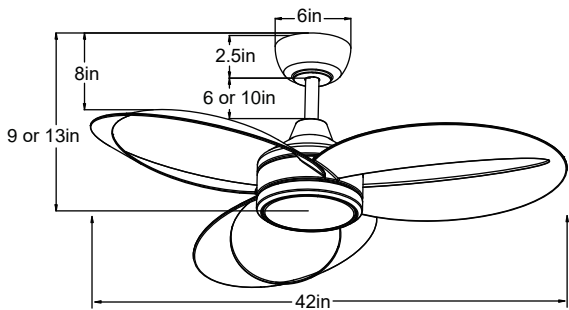

Remote Control Operation

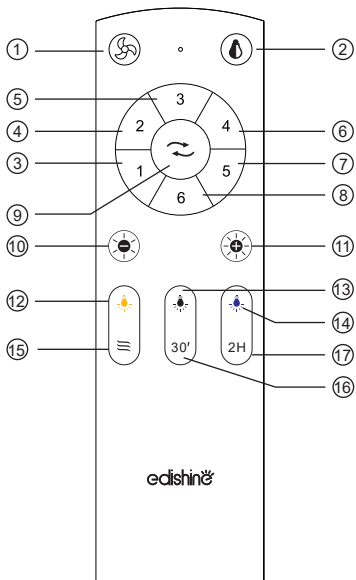

Q: How to control the fan to turn on/off?

A: Please press button 1  to turn the fan on/off.

Q: How to control the light to turn on/off?

A: Please press button 2  to turn on/off the light.

Q: How to adjust the airflow of the fan?

A: Please press button 3/4/5/6/7/8  respectively. Edishine provides you with 1-6 levels of wind speed gears, providing you with multi-level comfortable airflow options.

Q: How to achieve the reversible control function of the fan?

A: Please press button 9 , you can choose to achieve downward airflow in summer and upward airflow in winter, for air convection, to bring you a comfortable ambient temperature.

Q: How to adjust the brightness?

A: Please press button 10/11   respectively to realize the diminishing/increasing of the light brightness to bring you a comfortable ambient brightness.



Q: How to adjust the color temperature?

A: Please press button 12/13/14    respectively, edishine provides you with 3000K/4000K/5000K color temperature choices.

Q: How to realize the automatic cycle adjustment of wind speed?

A: Please press button 15 , edishine provides you with fan 1-5 speeds of airflow automatic circulation adjustment, closer to the natural wind state, ensures more comfortable living environment.

Q: How to set the timer function?

A: Please press button 16/17  , edishine offers you a choice of timing function for 30min and 2H.

Functional Operation

Q: How to pair/unpair the remote control with the fan?

A:

Pair: Turn on the wall switch. Within 10 seconds of the fan being powered on, press and hold button 1  on the remote control for 3 seconds. When you hear a “beep” sound, pairing is successful.

Unpair: Turn on the wall switch. Within 10 seconds after the fan is powered on, press and hold remote control button 1  for 3 seconds. When you hear a long “beep”, the pairing is released.

Q: How to pair/unpair 1 remote control with multiple ceiling fan with light?

A: Simultaneously power multiple ceiling fan with light, repeat the above steps to complete.



Q: How to achieve the opening/closing of the buzzer sound?

A:



Turn On: Press and hold remote control button 2  for 3 seconds. When you hear a "beep" sound, the buzzer is turned on.

Turn Off: Press and hold remote control button 2  for 3 seconds. When you hear a long "beep" sound, the buzzer is turned off.

Q: How to set the timing?

A: Press buttons 16/17  , and when you hear a "beep" sound, the corresponding timing operation will be activated (Note: To ensure the success of the timing function, do not turn off the buzzer of the timing button).

Q: How to cancel the timing?

A: Within 3 seconds, press twice button 16  or button 17 .

When you hear a long "beep" sound, the timing function will be canceled.

One Year Limited Warranty

Supported by our professional R&D team and QC team, we provide One Year Warranty for materials and workmanship from the purchase date. Please note that the warranty does not cover damage caused by personal misuse or improper installation.

Please attach your Order ID and Name so that our dedicated customer service team can help you better.