

Tools Recommended

**EN\_IMPORTANT, RETAIN FOR FUTURE REFERENCE: READ CAREFULLY.**

**FR\_IMPORTANT: A LIRE ATTENTIVEMENT ET À CONSERVER POUR CONSULTATION ULTÉRIEURE.**

**ES\_IMPORTANTE, LEA Y GUARDE PARA FUTURAS REFERENCIAS.**

**PT\_IMPORTANTE, RETER PARA REFERÊNCIA FUTURA: LEIA ATENTAMENTE.**

**DE\_WICHTIG! SORGFÄLTIG LESEN UND FÜR SPÄTER NACHSCHLAGEN AUFBEWAHREN.**

**IT\_IMPORTANTE! CONSERVARE IL PRESENTE MANUALE PER FUTURO RIFERIMENTO E LEGGERLO ATTENTAMENTE.**

**BOX  
1-2**

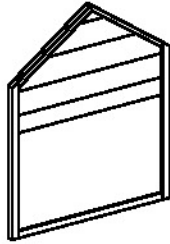

② 1pc

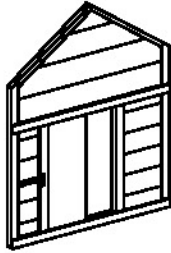

③ 1pc



④ 2pcs

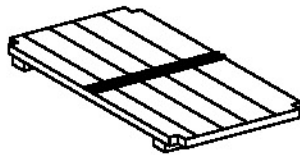

⑦ 2pcs

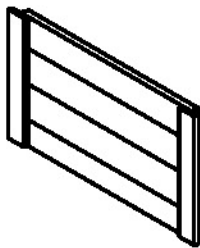

⑧ 2pcs

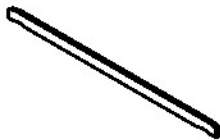

⑩ 2pcs

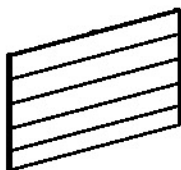

⑭ 1pc

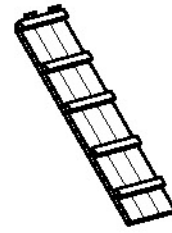

⑮ 1pc

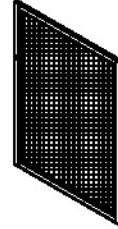

⑯ 1pc

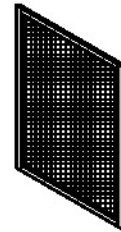

⑰ 2pcs

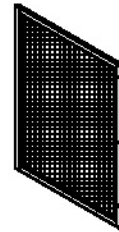

⑱ 2pcs

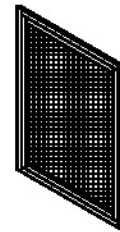

⑲ 1pc

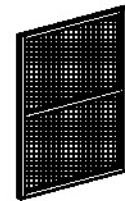

⑳ 1pc

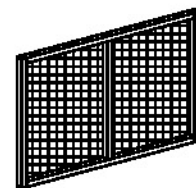

㉓ 1pc

**BOX  
1-2**

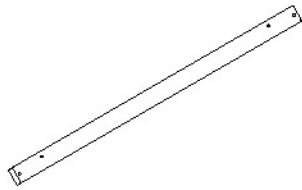

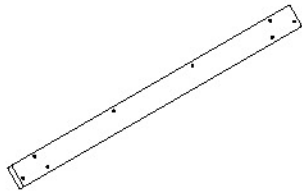

24 1pc



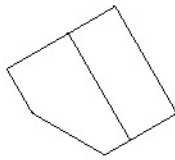









25 1pc

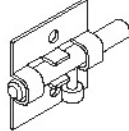

26 2pcs

A	 3.5*50	22pcs +2
B	 3.5*35	40pcs +2

C	 3.5*30	20pcs +1
D	 3*25	4pcs
E	 3*16	48pcs +2
F	 $\phi 6*45$	8pcs +1
G		1pc
H		3pcs
I		1pc
J		2pcs
K		3pcs
L		1pc

**BOX  
2-2**

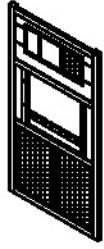

① 2pcs

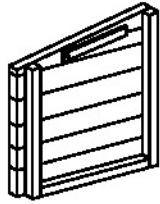

⑤ 2pcs

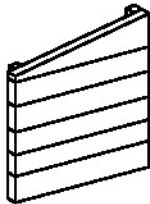

⑥ 2pcs

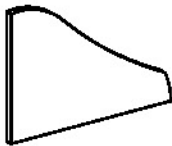

⑨ 2pcs

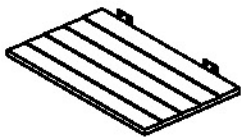

⑪ 2pcs



⑫ 1pc

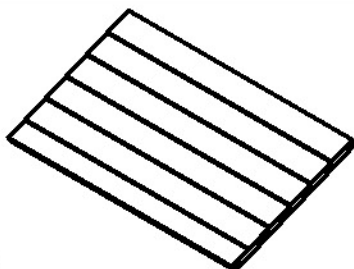

⑬ 2pcs

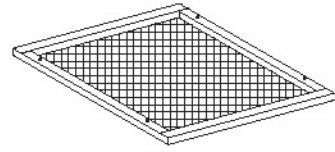

⑳ 2pcs

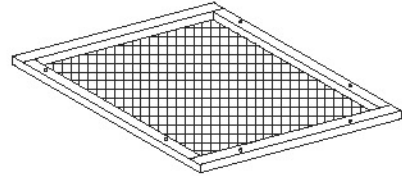

㉒ 1pc

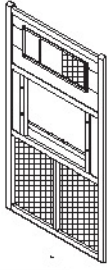

①x02

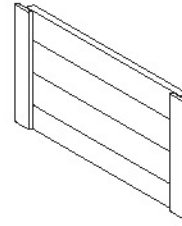

⑧x02

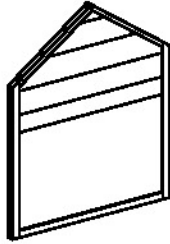

②x01

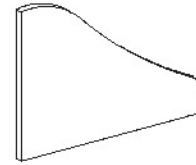

⑨x02

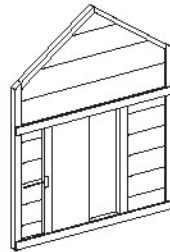

③x01

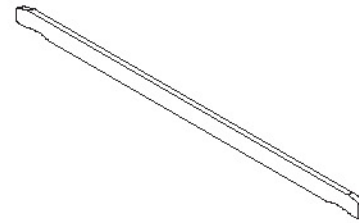

⑩x02



④x02

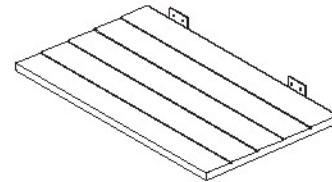

⑪x02

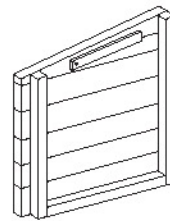

⑤x02

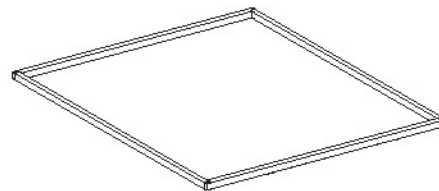

⑫x01

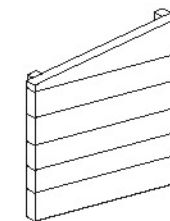

⑥x02

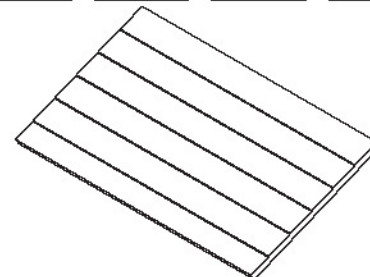

⑬x02

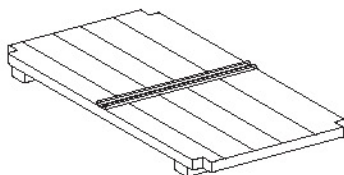

⑦x02



⑭x01



15 x01

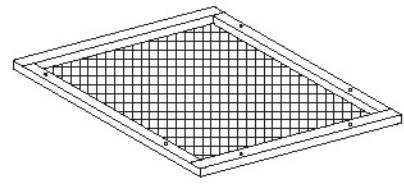

22 x01

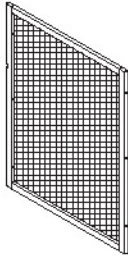

16 x01

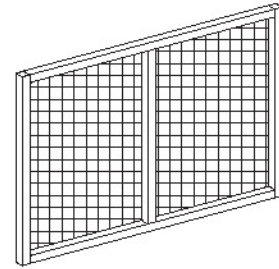

23 x01

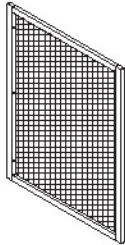

17 x02

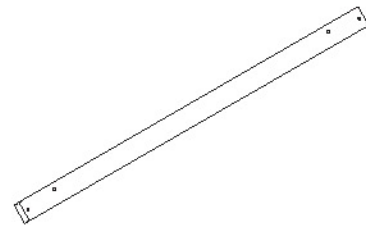

24 x01

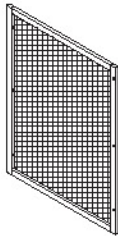

18 x02

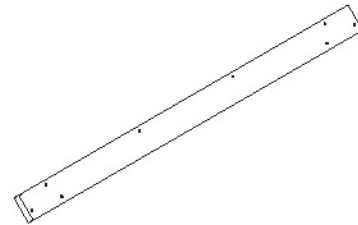

25 x01

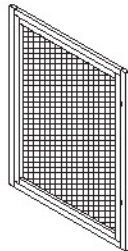

19 x01

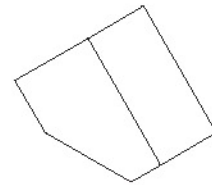

26 x02

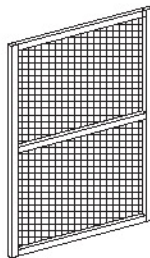

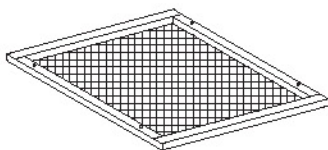

20 x01



21 x02

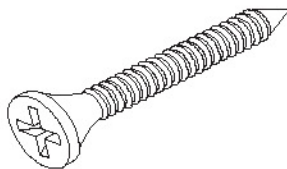
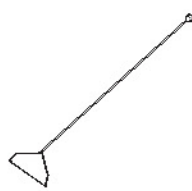
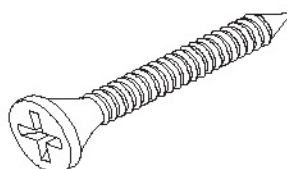

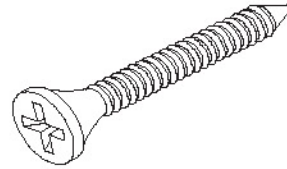
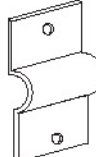
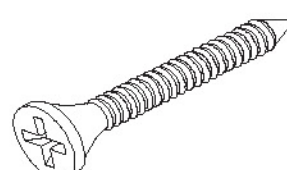
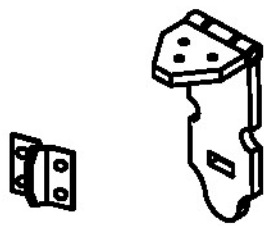
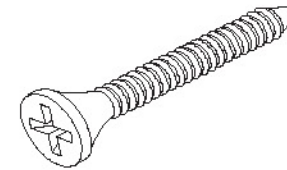
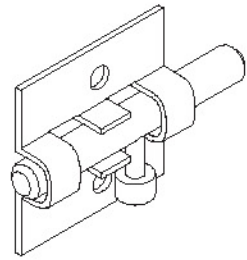
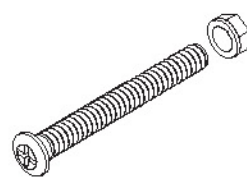
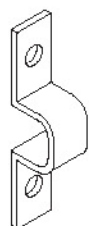
<p><b>A</b> x22+2(spare)</p>  <p>M3.5*50</p>	<p><b>G</b> x01</p> 
<p><b>B</b> x40+2(spare)</p>  <p>M3.5*35</p>	<p><b>H</b> x03</p> 
<p><b>C</b> x20+1(spare)</p>  <p>M3.5*30</p>	<p><b>I</b> x01</p> 
<p><b>D</b> x04</p>  <p>M3*25</p>	<p><b>J</b> x02</p> 
<p><b>E</b> x48+2(spare)</p>  <p>M3*16</p>	<p><b>K</b> x03</p> 
<p><b>F</b> x08+1(spare)</p>  <p>M6*45</p>	<p><b>L</b> x01</p> 

**EN** Do not confuse similar screws.  
**FR** Ne pas confondre des vis similaires.  
**ES** No confunda tornillos similares.  
**PT** Não confundir parafusos semelhantes.  
**DE** Verwechseln Sie ähnliche Schrauben nicht.  
**IT** Non confondere le viti simili.

**NOTE**

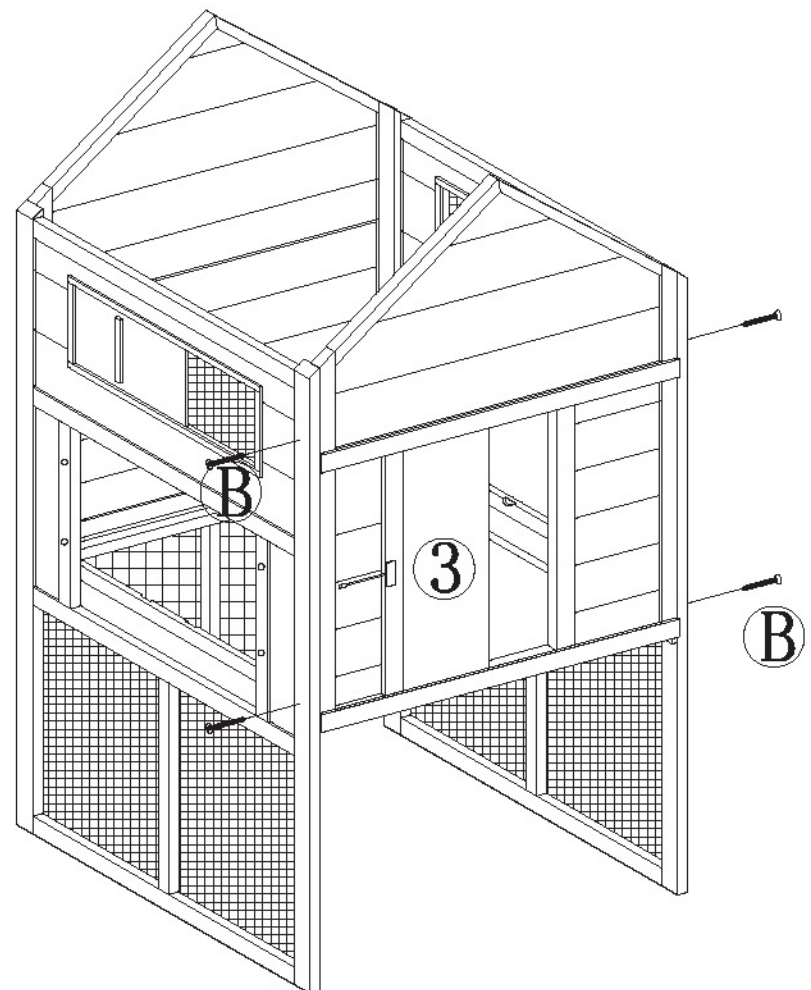
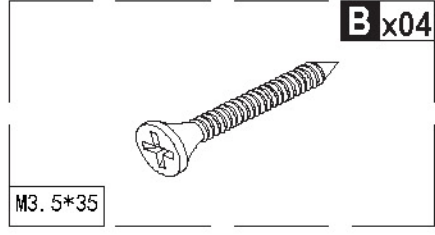
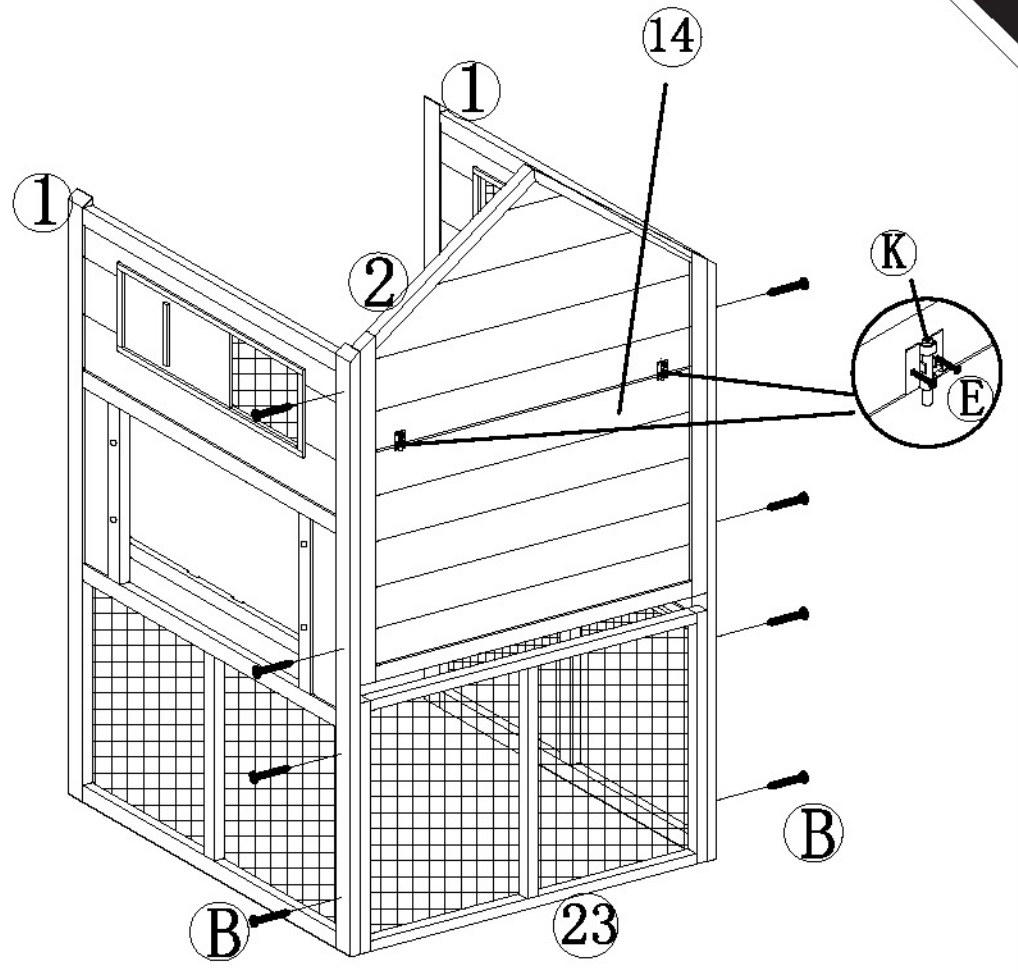
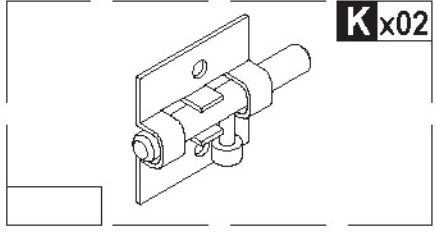
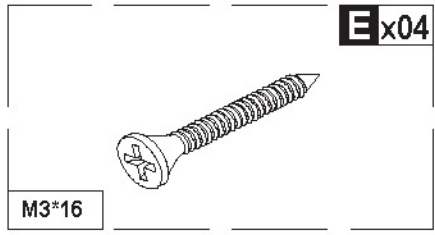
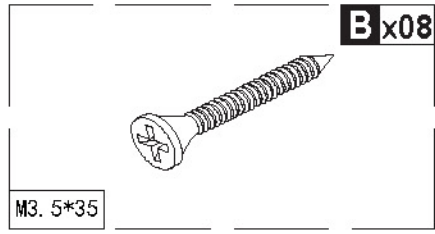

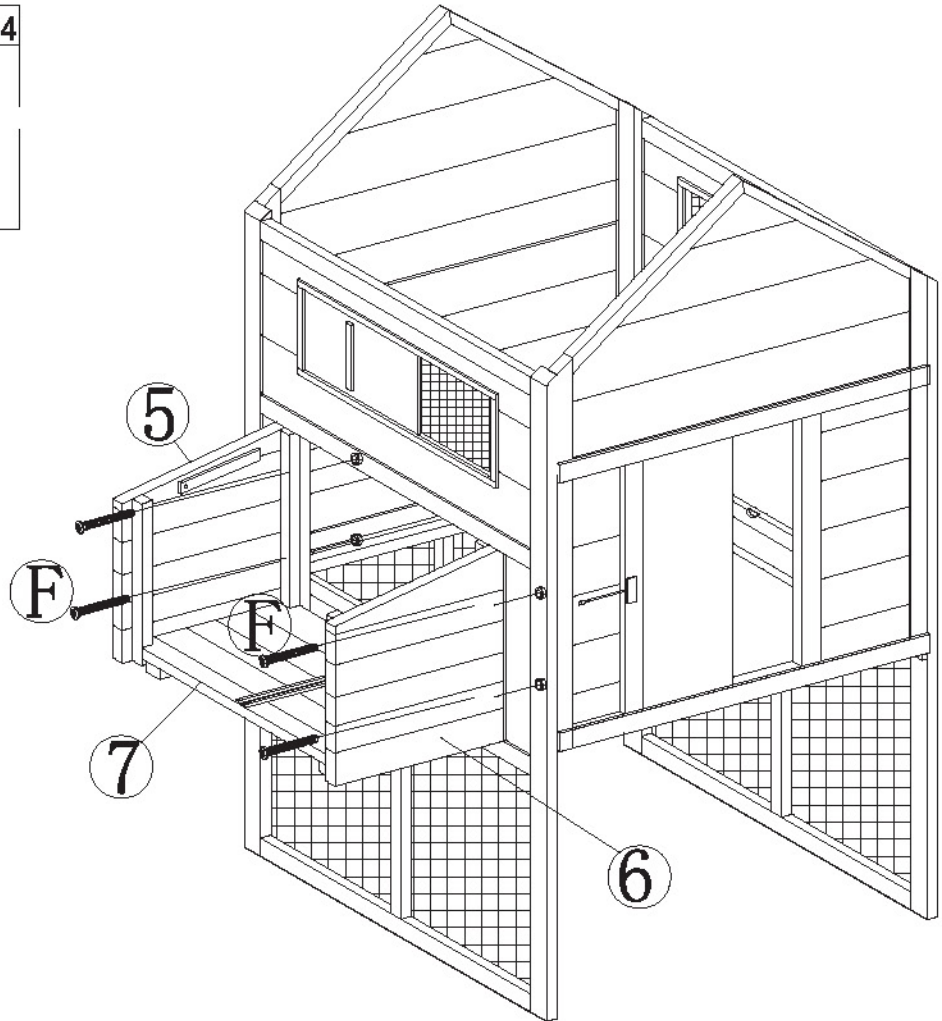
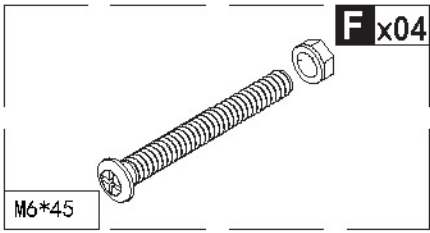
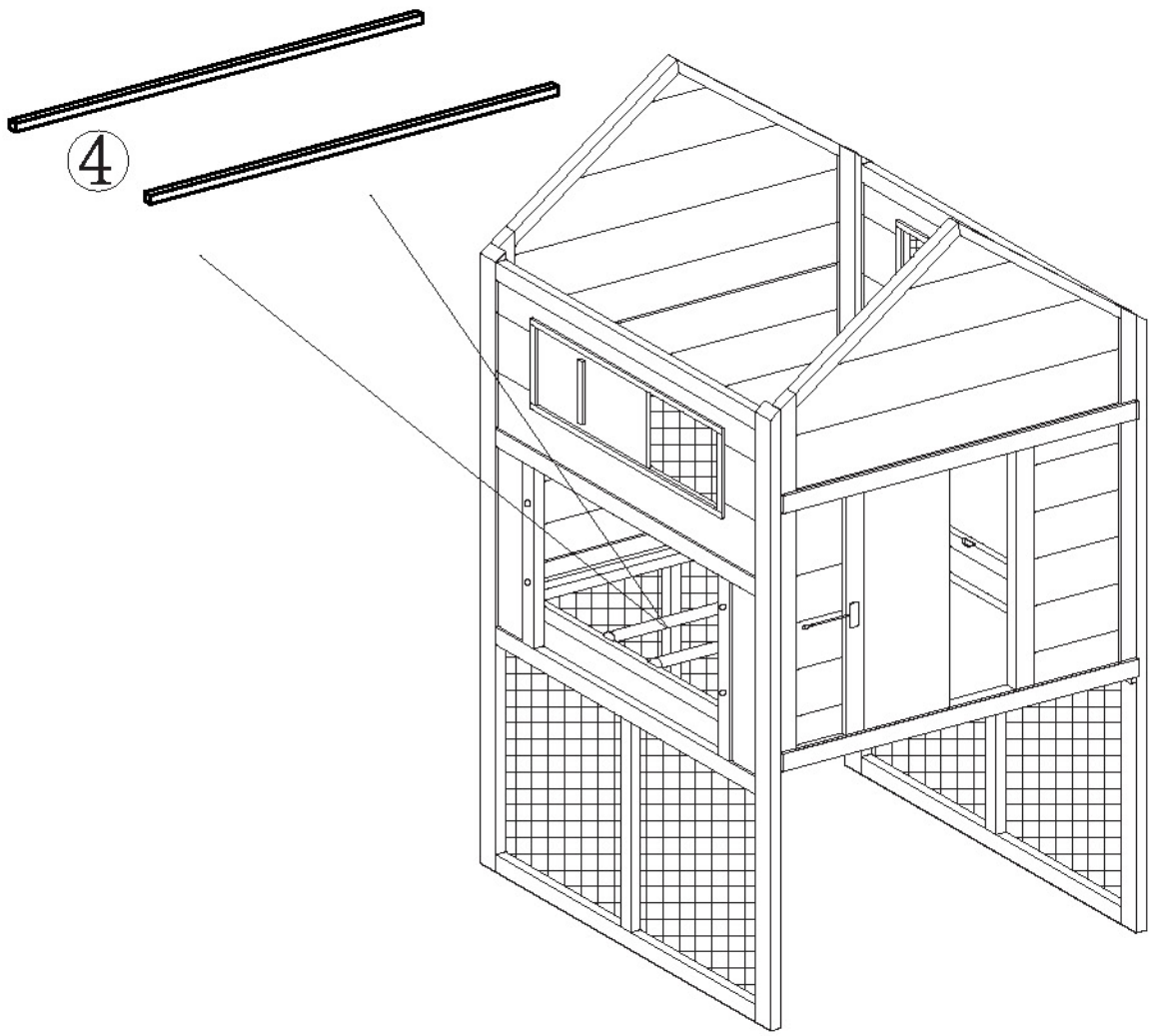

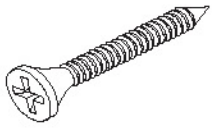

**B**x04

M3. 5\*35

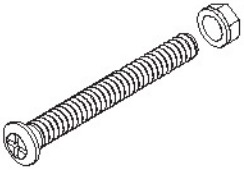
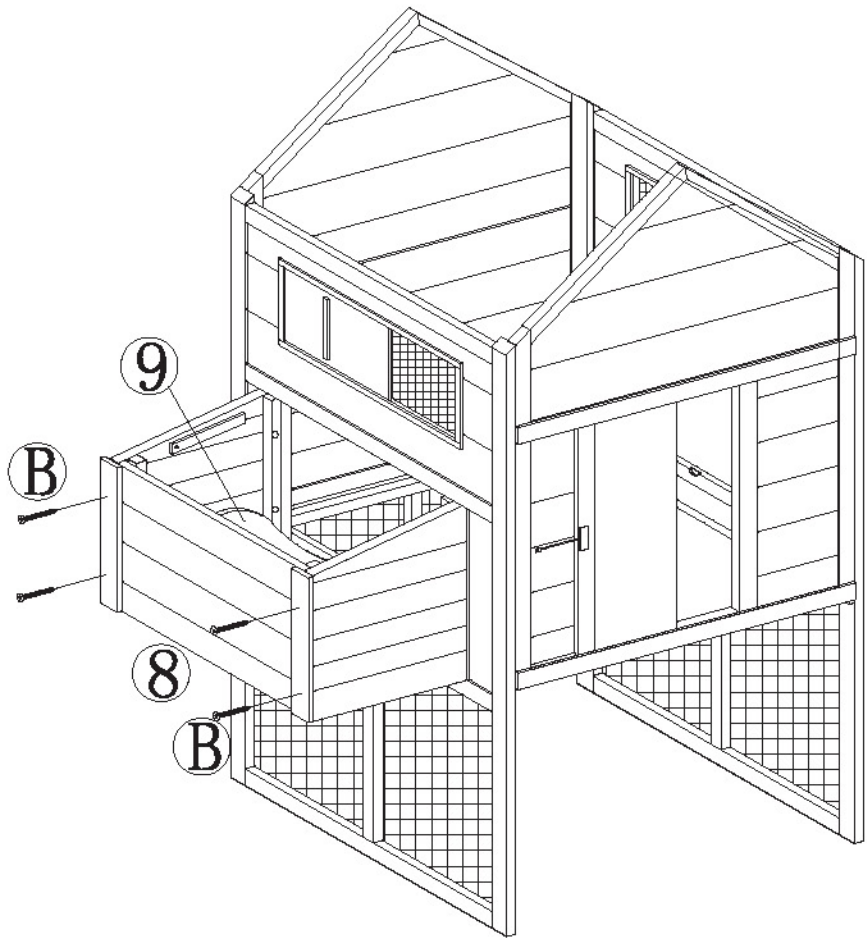

**F**x04

Ø6\*45

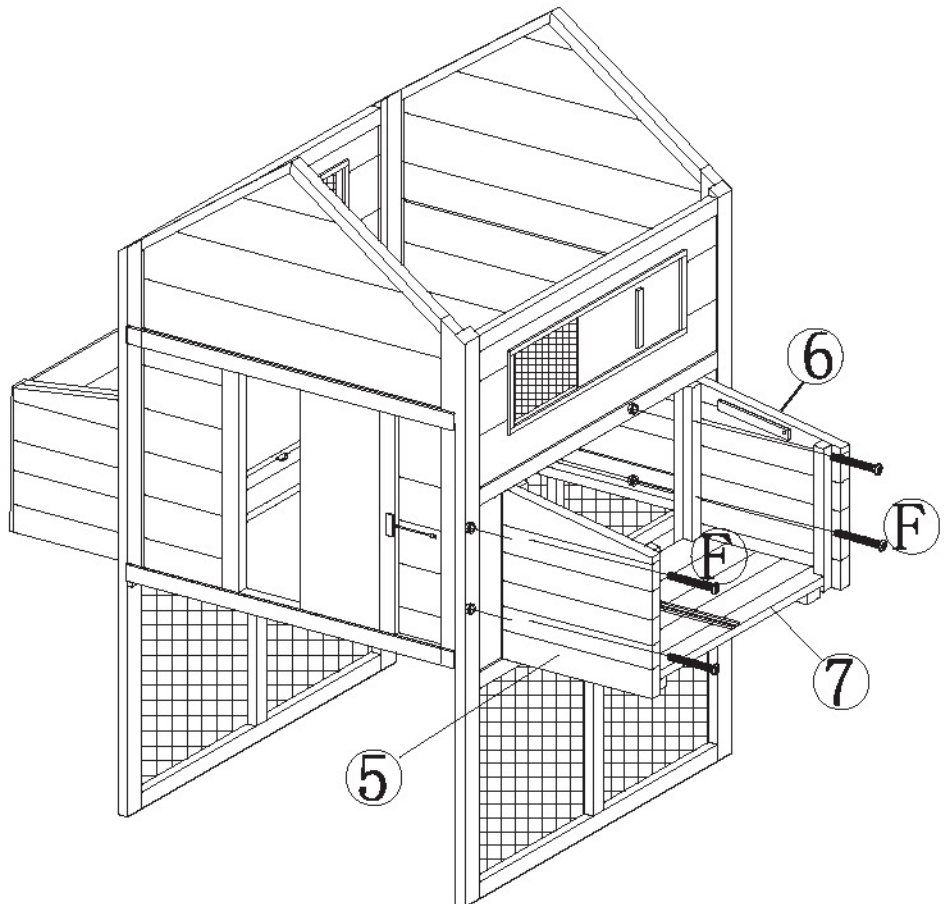

**B**x04

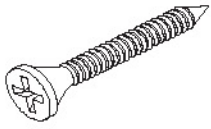

M3. 5\*35

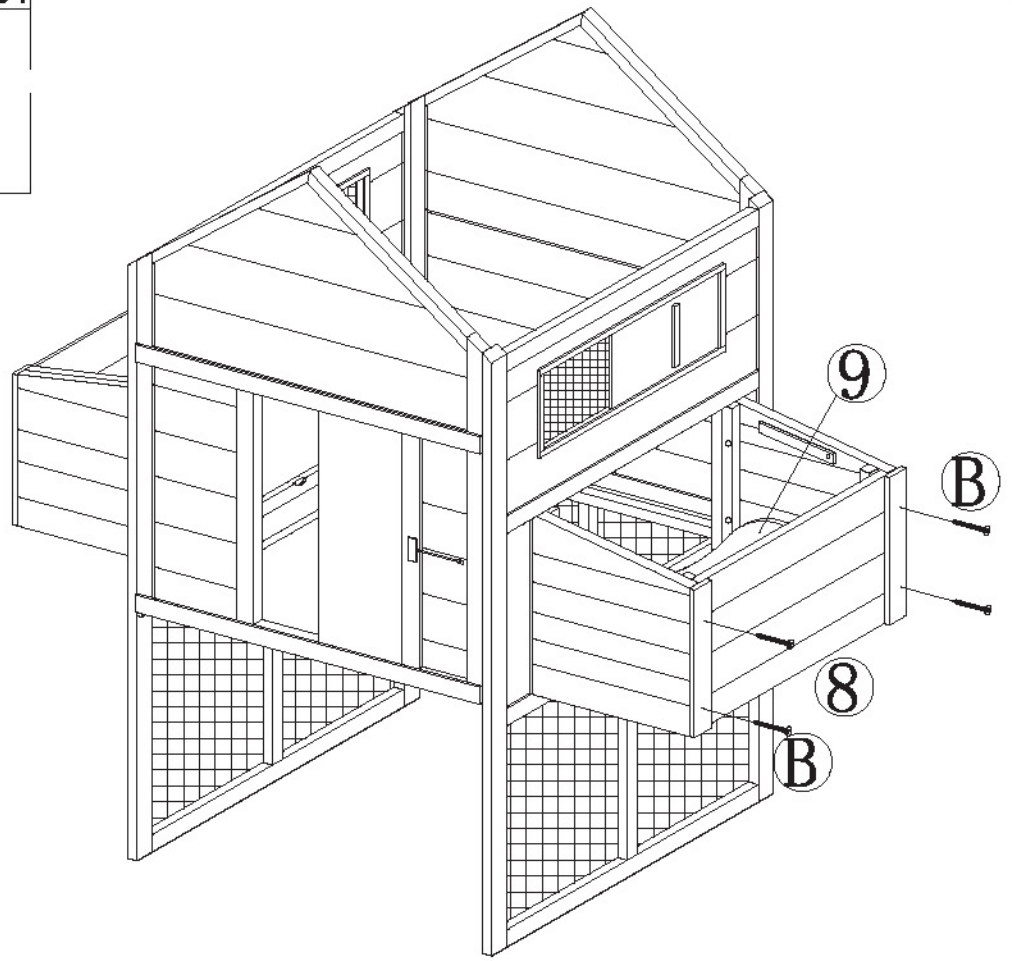

**C**x02

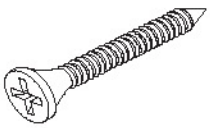

M3. 5\*30

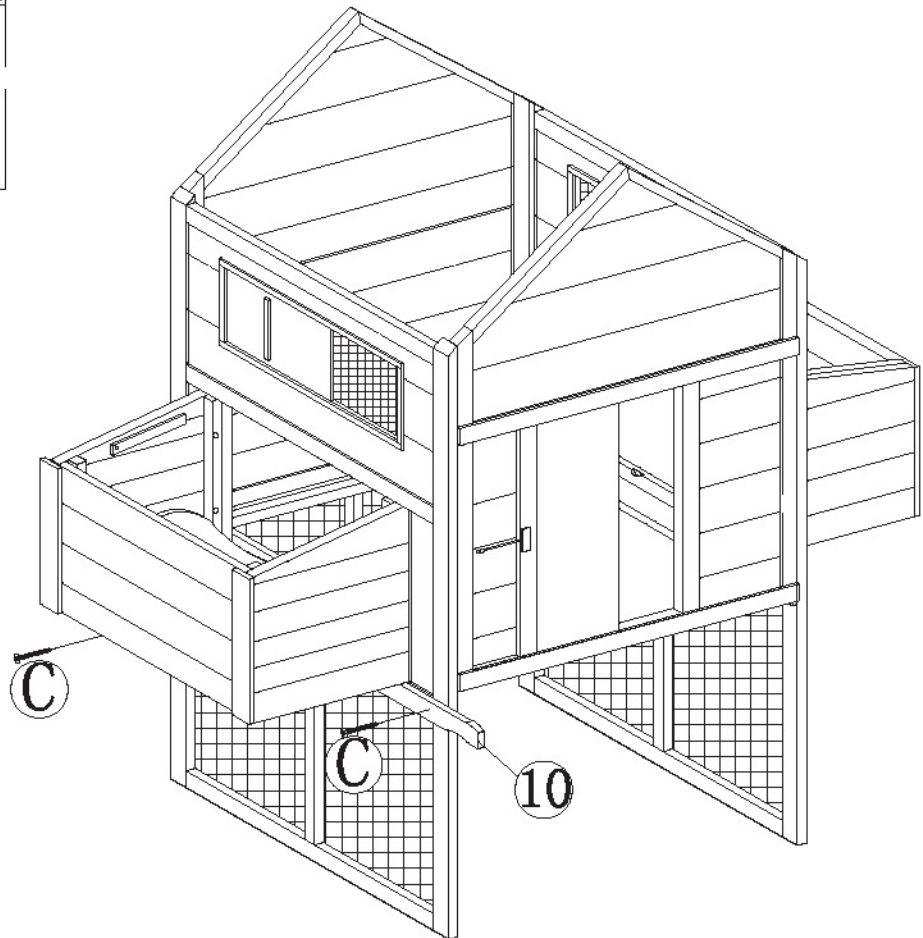

**C**x02

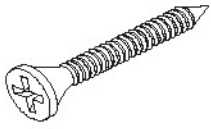

M3. 5\*30

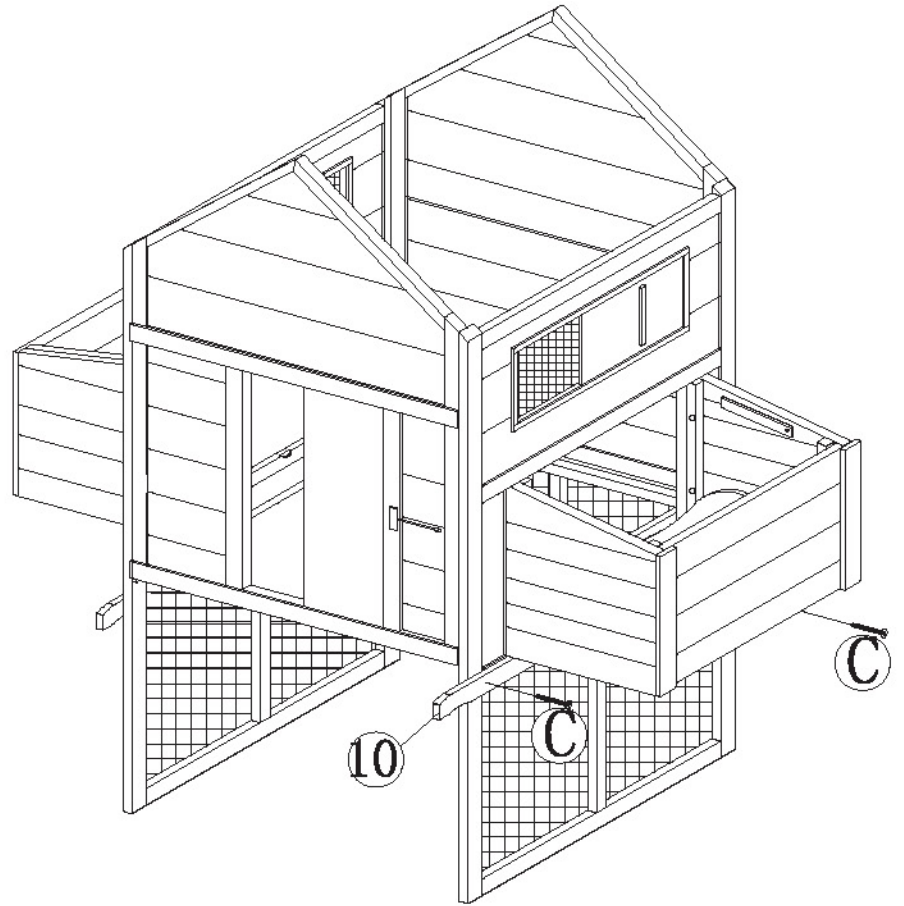

**E**x11

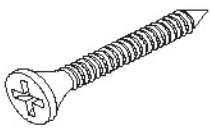

M3\*16

**J**x01

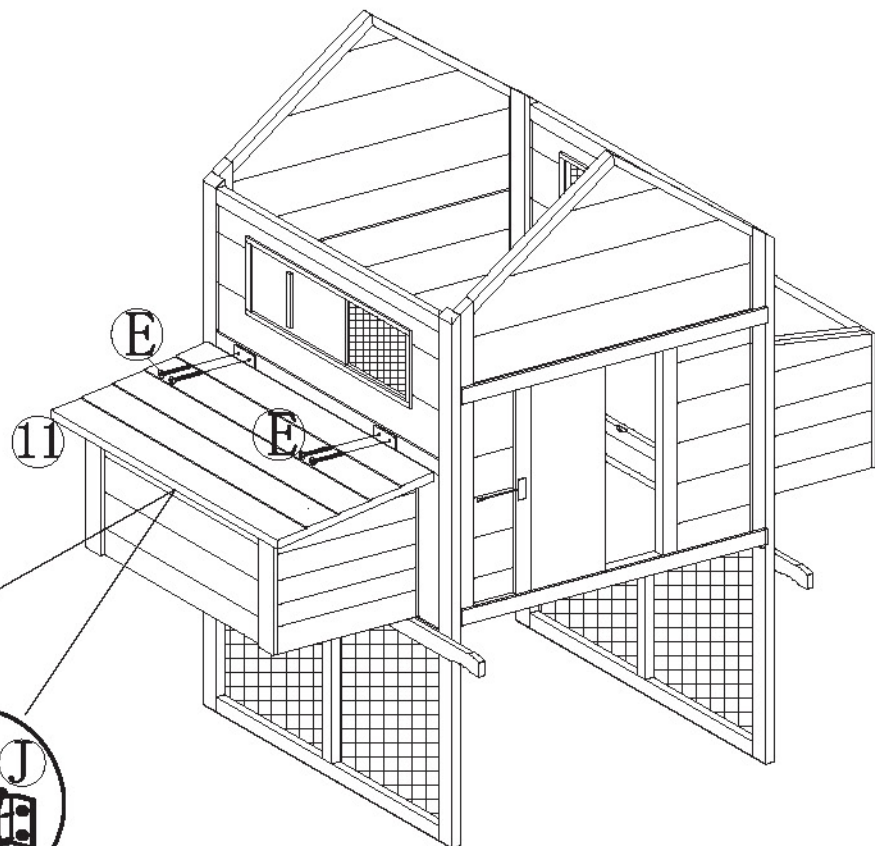
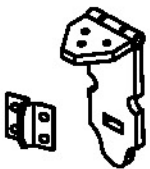

**E**x11

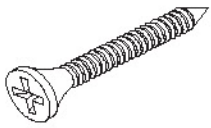

M3\*16

**J**x01

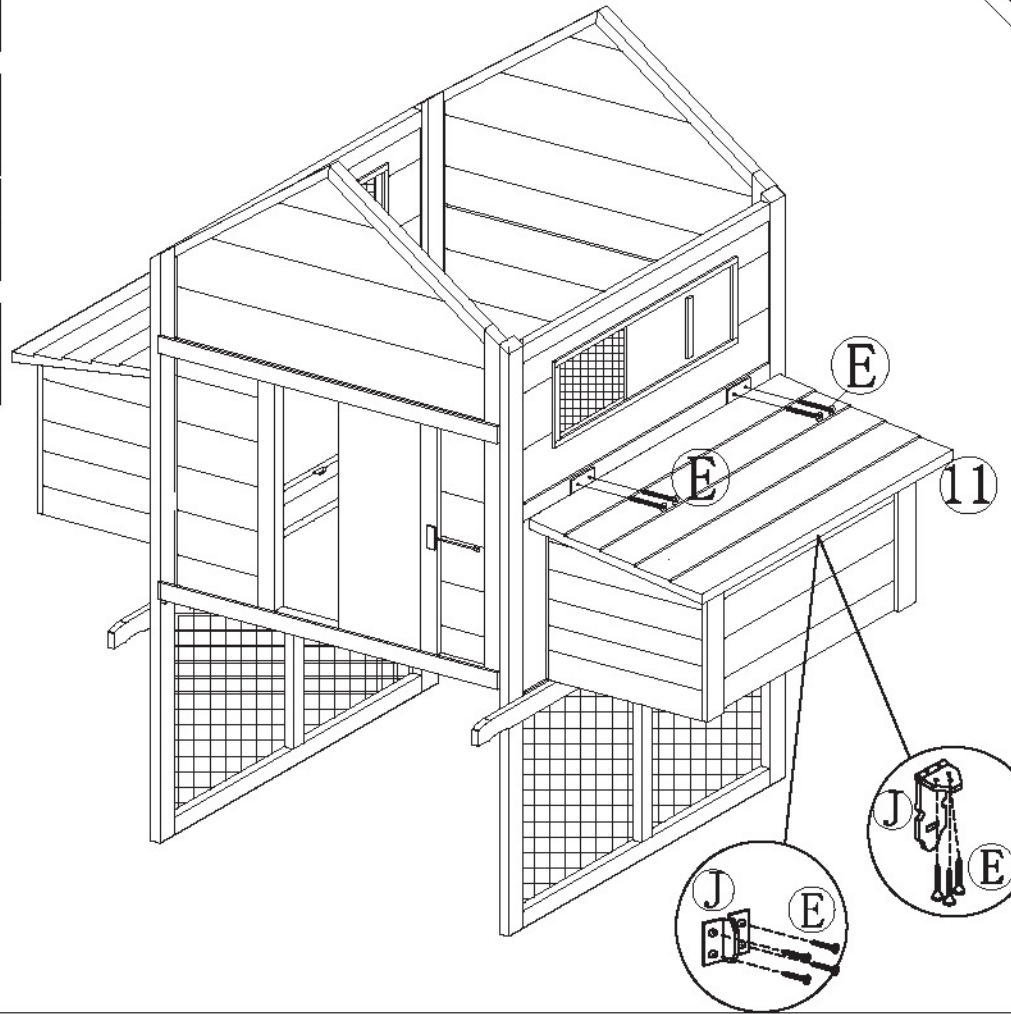
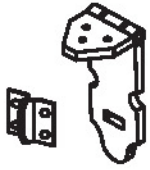

**E**x12

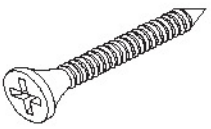

M3\*16

**H**x03

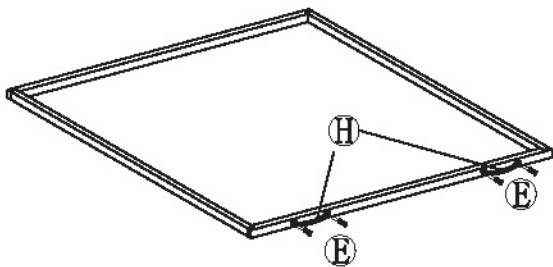
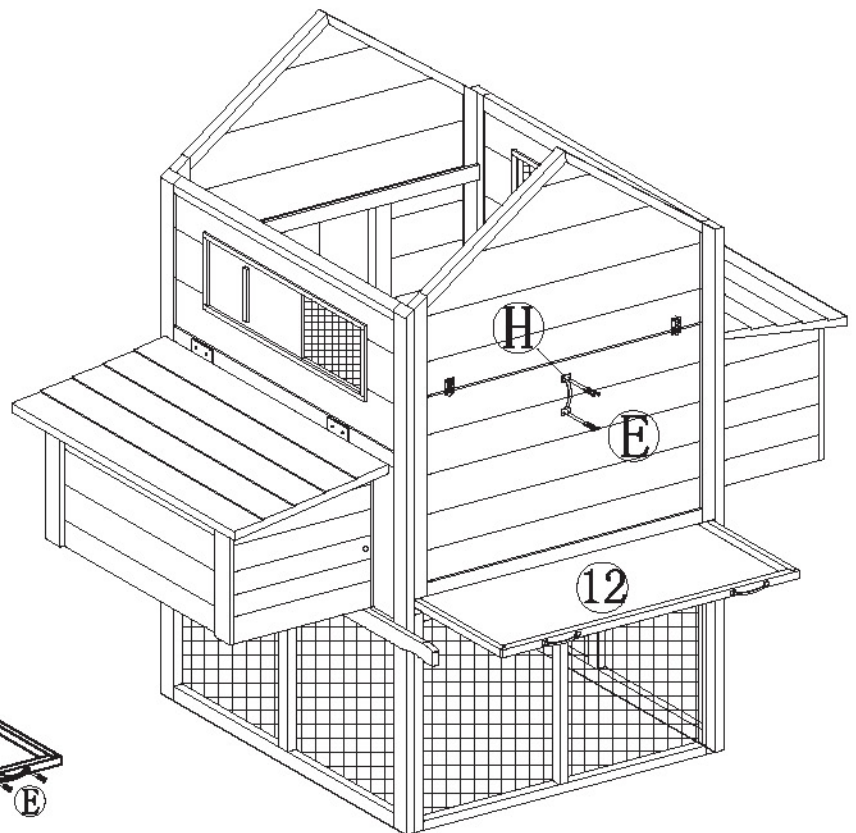

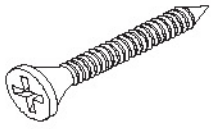

Cx08

M3. 5\*30

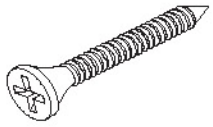
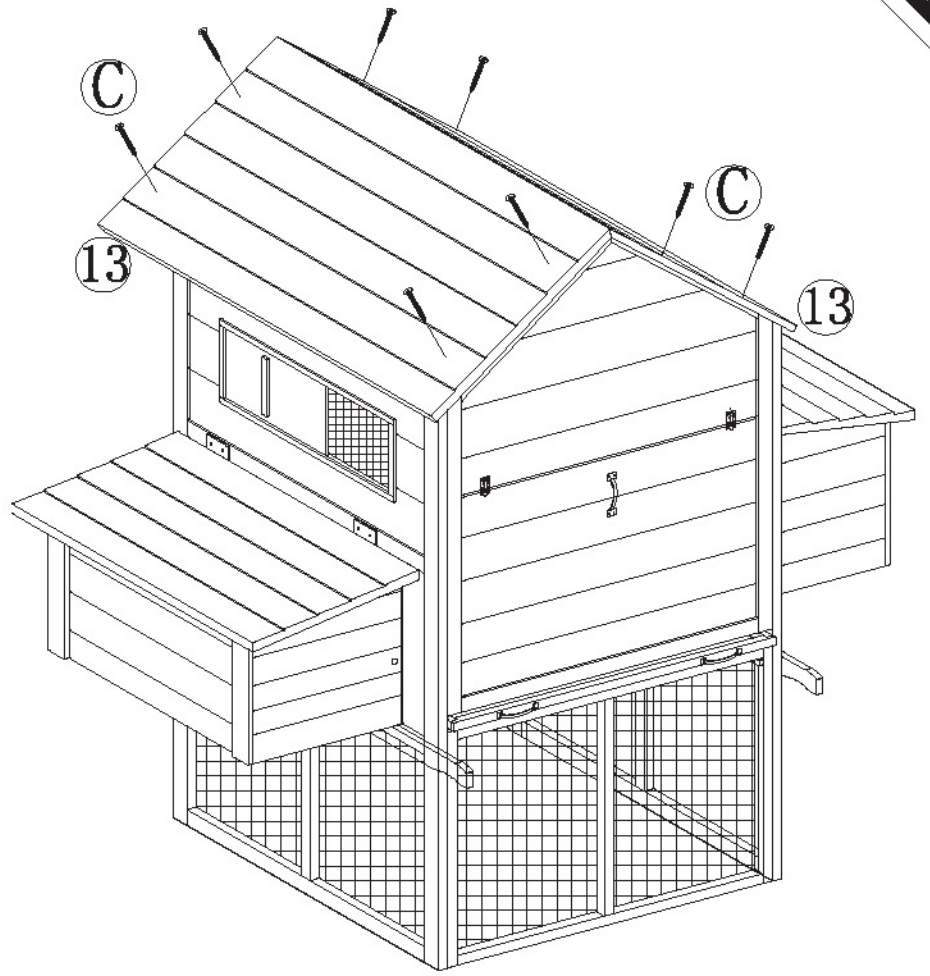

Cx08

M3. 5\*30

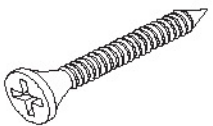

Dx04

M3\*25

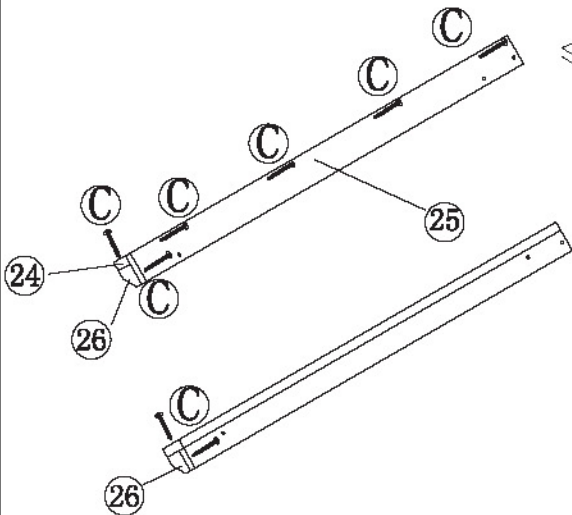
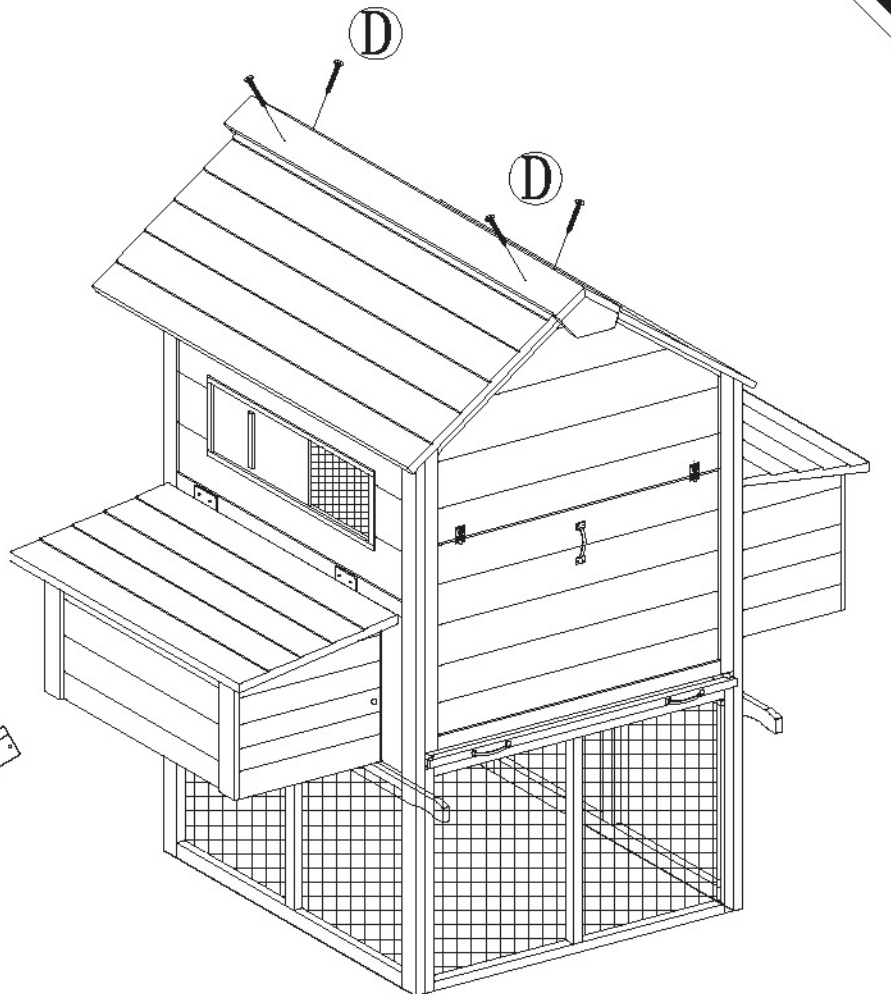

**E**x06

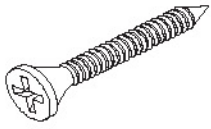

M3\*16

**G**x01

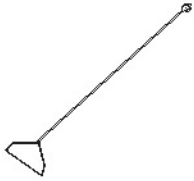

**I**x01

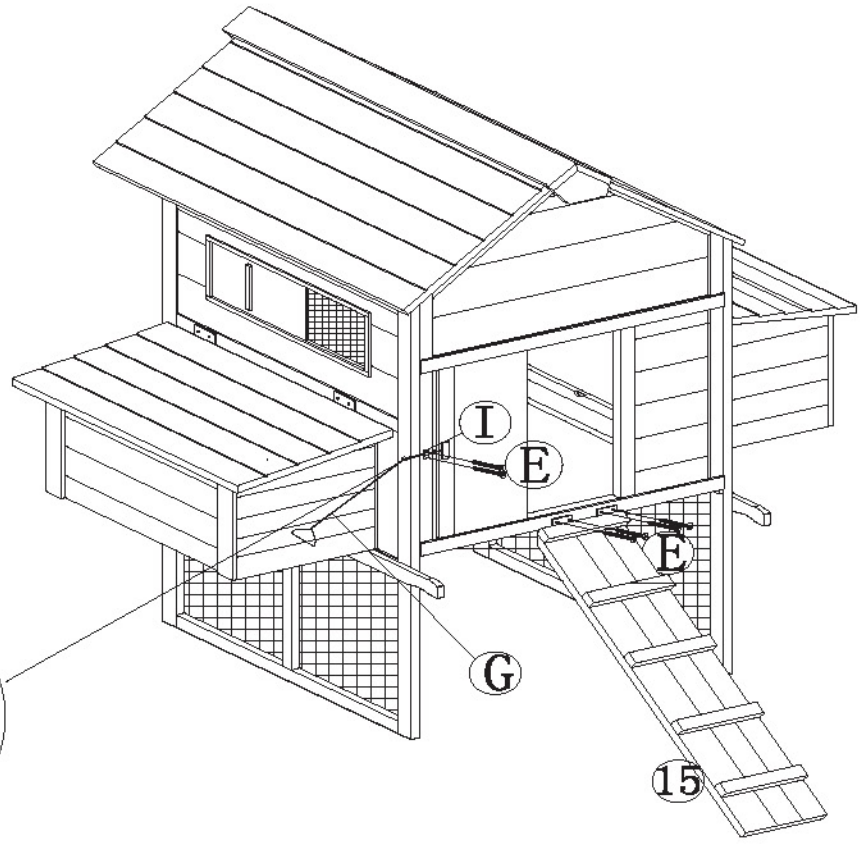
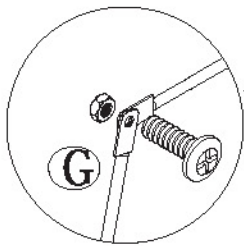
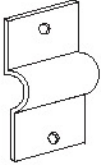

**A**x06

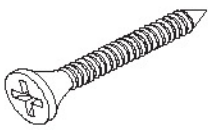

M3. 5\*50

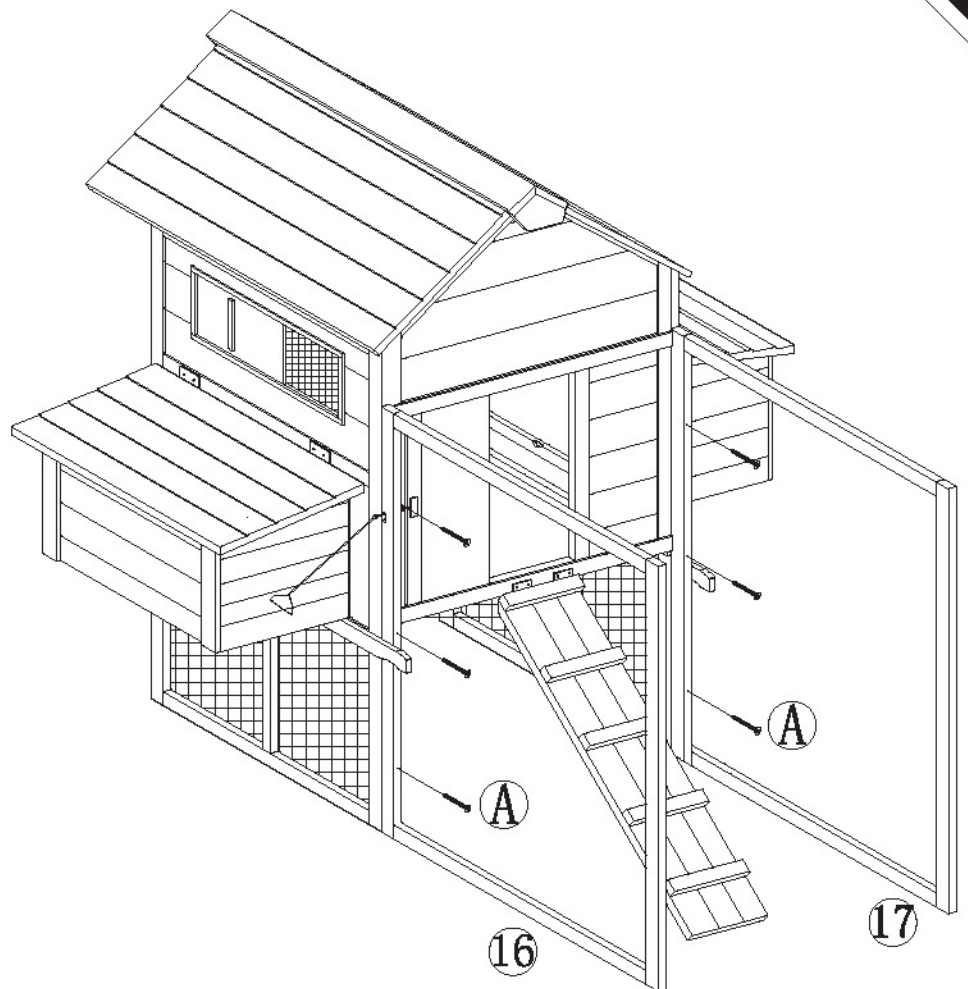

**A**x06

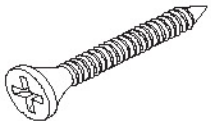

M3. 5\*50

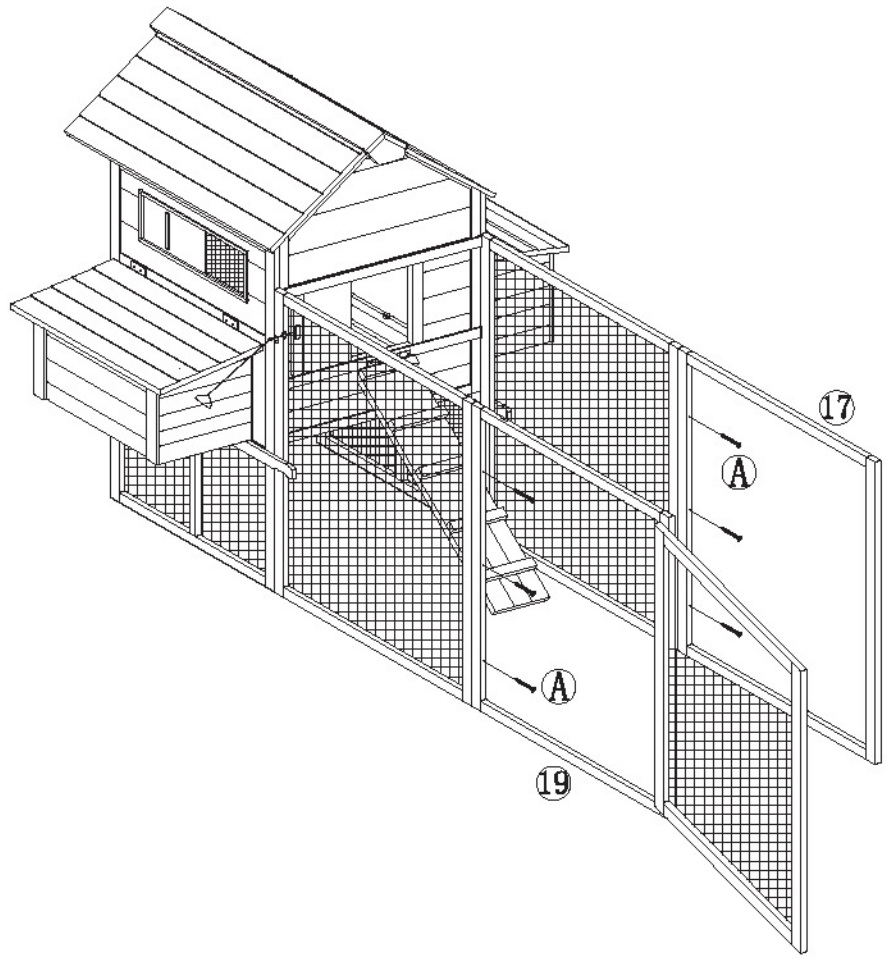

**A**x06

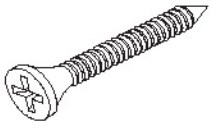

M3. 5\*50

**E**x04

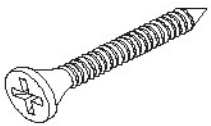

M3\*16

**K**x01

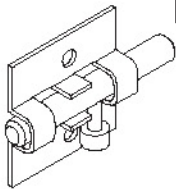

**L**x01

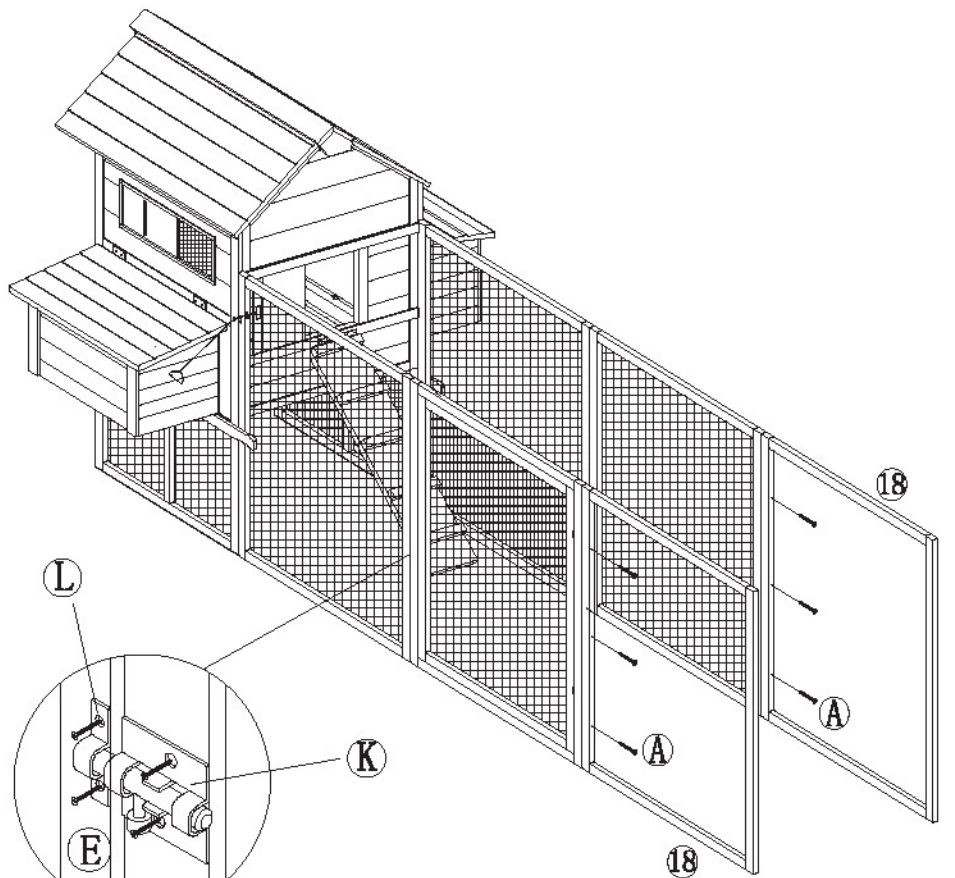
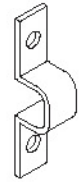

**A**x04

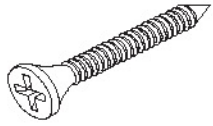

M3. 5\*50

**B**x06

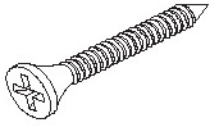

M3. 5\*35

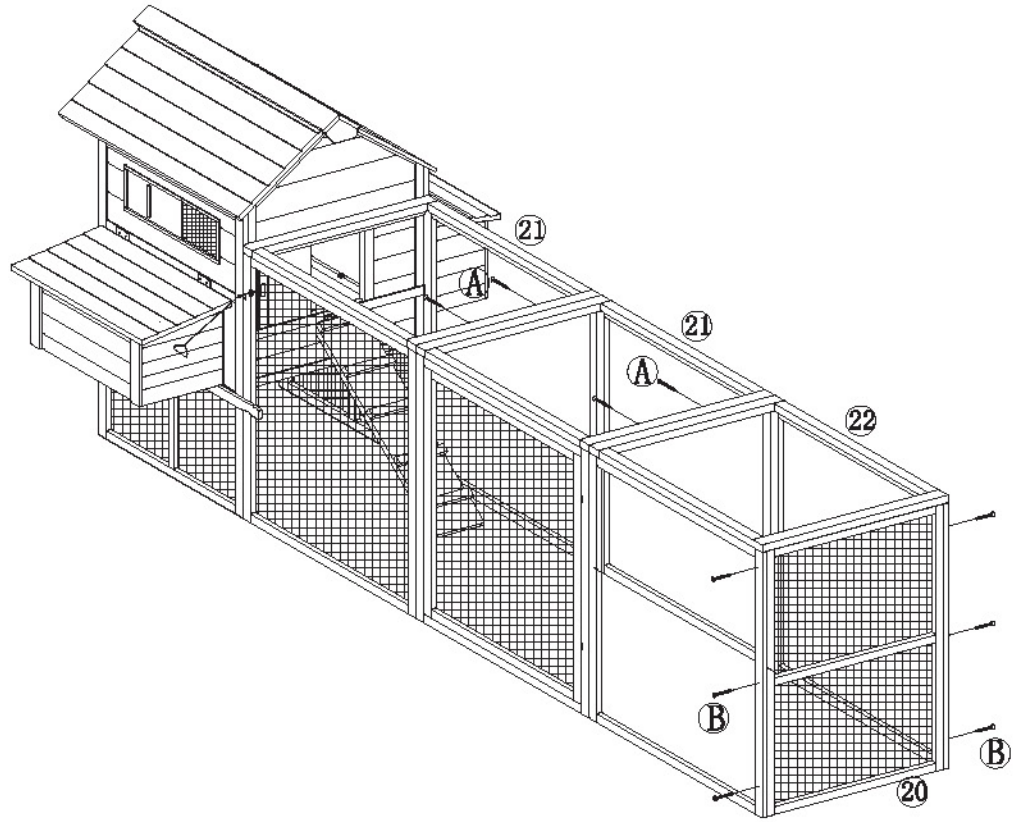

**B**x14

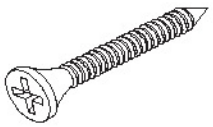

M3. 5\*35

