

Assembly Instruction

Accent Cabinet

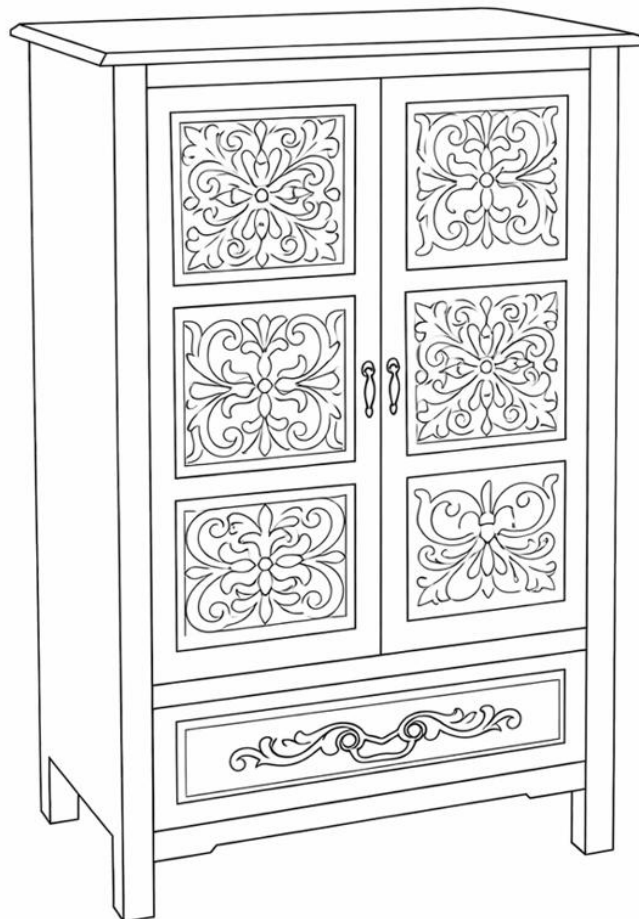













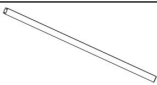



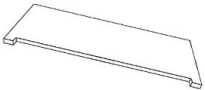
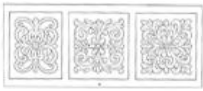
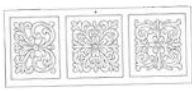

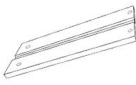
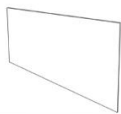





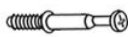





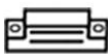

⚠ WARNING:

- Read all instructions carefully and completely before assembly and use.
- Retain for future reference.
- **DO NOT use power tools.**
- **DO NOT over-tighten hardware.**
- Periodically check all hardware and re-tighten as necessary.
- DO NOT sit or stand on product. Use only for intended purpose.
- DO NOT exceed 80 lbs for the tabletop and 30 lbs for shelf, 10 lbs for drawer, evenly distributed.

Parts List

Check all parts before assembly

Item no.	Reference image	QTY.	Item no.	Reference image	QTY.	Item no.	Reference image	QTY.
A.		1	B.		1	C.		1
D.		2	E.		1	F.		1
G.		1	H.		1	I.		1
J.		1	K.		1	L.		1
M.		1	N.		1	O.		1
P.		1						
H1.		2+1	H2.		14+2	H3.	 19mm	4+1
H4.		2+1	H5.		4+1	H6.		4+1
H7.	 25mm	4+1	H8.		12+2	H9.		1
H10.		1	H11.		2	H12.		1
H13.		2+1	H14.		2+1	H15.		4
H16.		2	H17.		4+1	H18.		4+1
H19.		4+1	H20.	 12mm	2+1	H21.	 14mm	4+1

Step 1: Put the Top (B) on a soft surface to protect the finish.

Attach the Magnet (H16) to Wooden strip (A) with screw (H3) by Spanner (H10). Attached Wooden strip (A) to panel (B) with Hex bolt (H1)& washer (H2) by Allen Key (H9) as shown below. Leave hardware loose in this step.

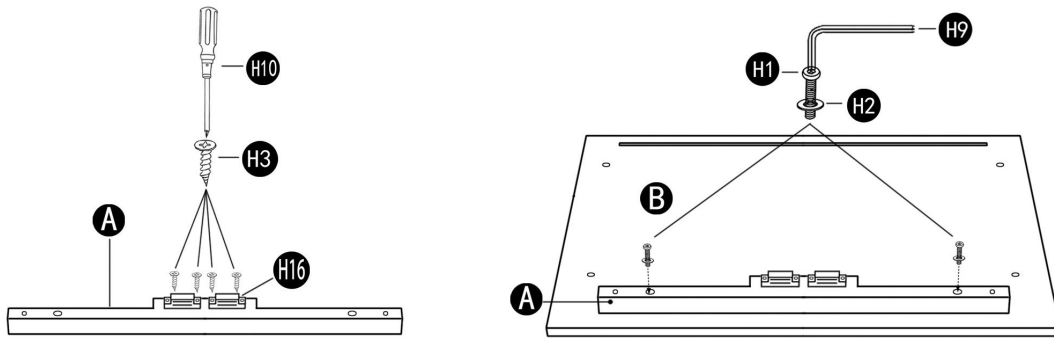

Step 2: Attach Panel (C) to Panel (B) with Hex bolt (H8)& washer (H2) by Allen Key (H9) as shown below. Insert Panel (D)& Wooden strip (E) to Panel (B) as shown below. Attach Panel (F) to Panel (B) with Hex bolt (H8)& washer (H2) by Allen Key (H9) as shown below. Leave hardware loose in this step.

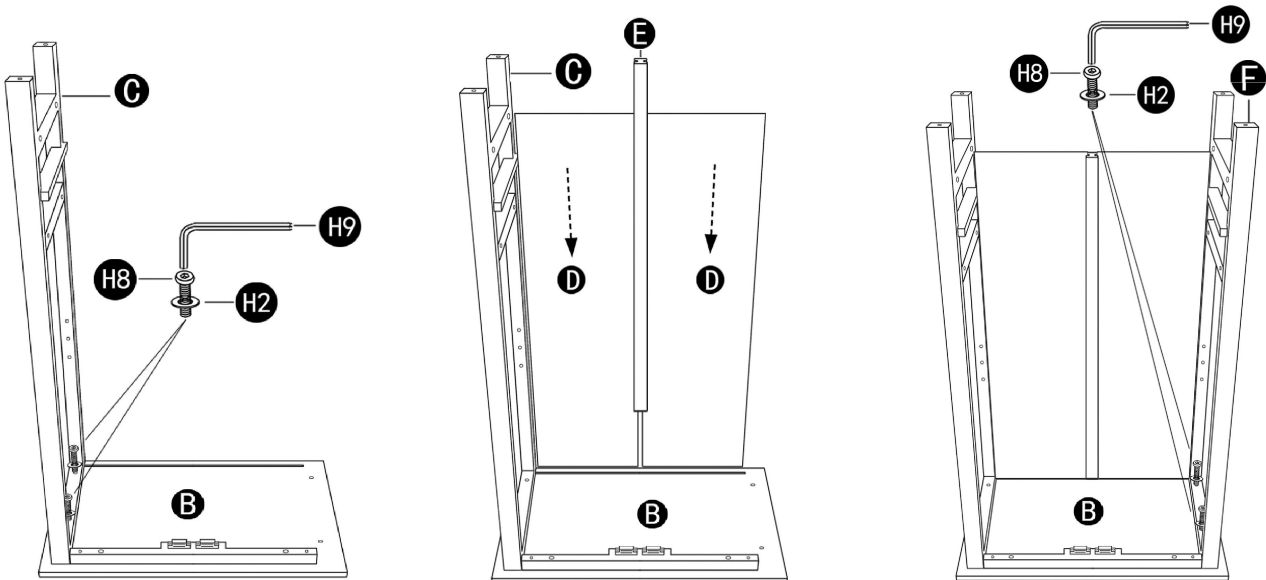

Step 3: Attach the Panel (G&H) to Panel (C&F) with Hex bolt (H8)& washer (H2) by Allen Key (H9). Attach the Foot pad (H15) to the bottom of the legs. Fully tighten all bolts from Step 1 to 3.

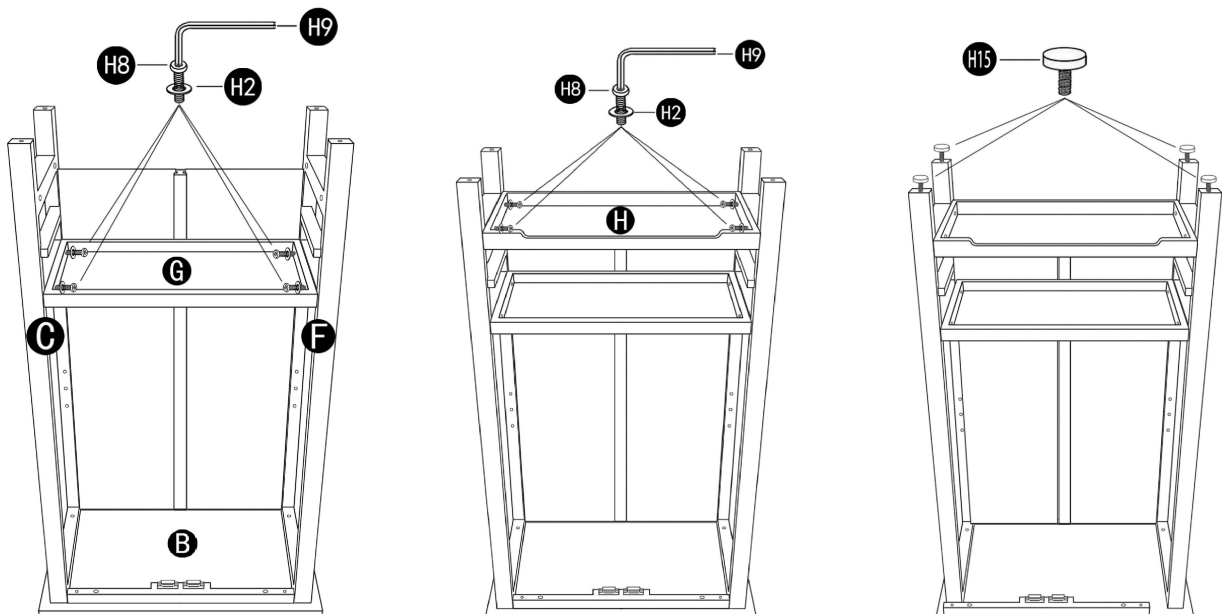

Step 4: Insert the Shelf Pin (H17) to the Panel (C&F). Place the Shelf (I) into inside.
(Each side panel with 6 adjustable holes.)

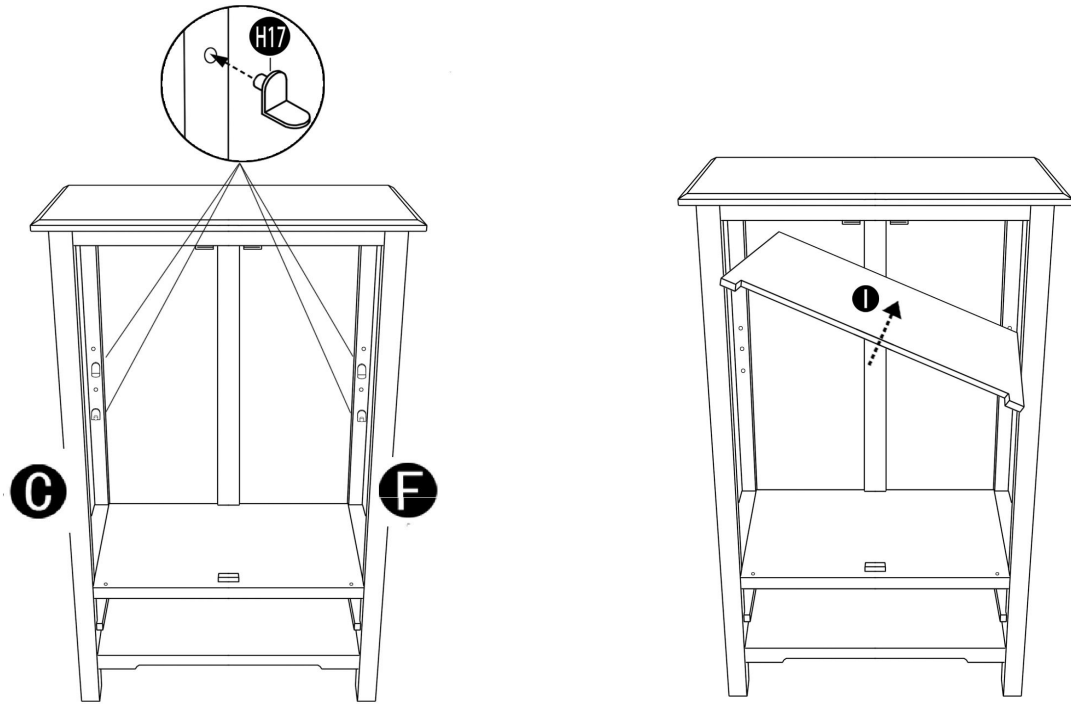

Step 5: Attach the door handle (H11) to each door using screw (H13) and tighten with the spanner (H10). Insert the bottom door pin (H18) into the hole on the cabinet first, then press down the top door pin (H18) to secure the door in place.

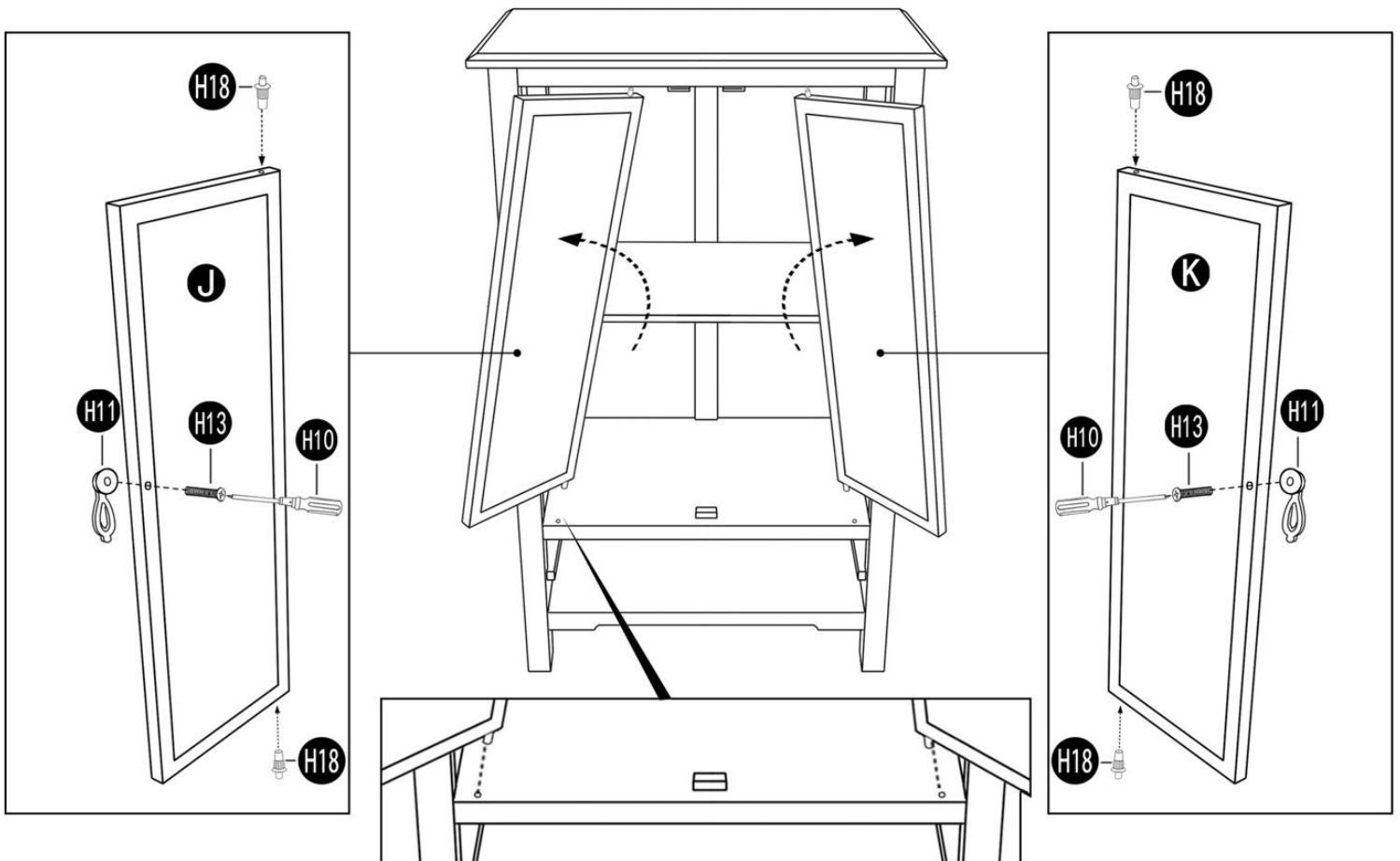

Step 6: Put the drawer's panel (L/M/N/O/P) on a soft surface to protect the finish.

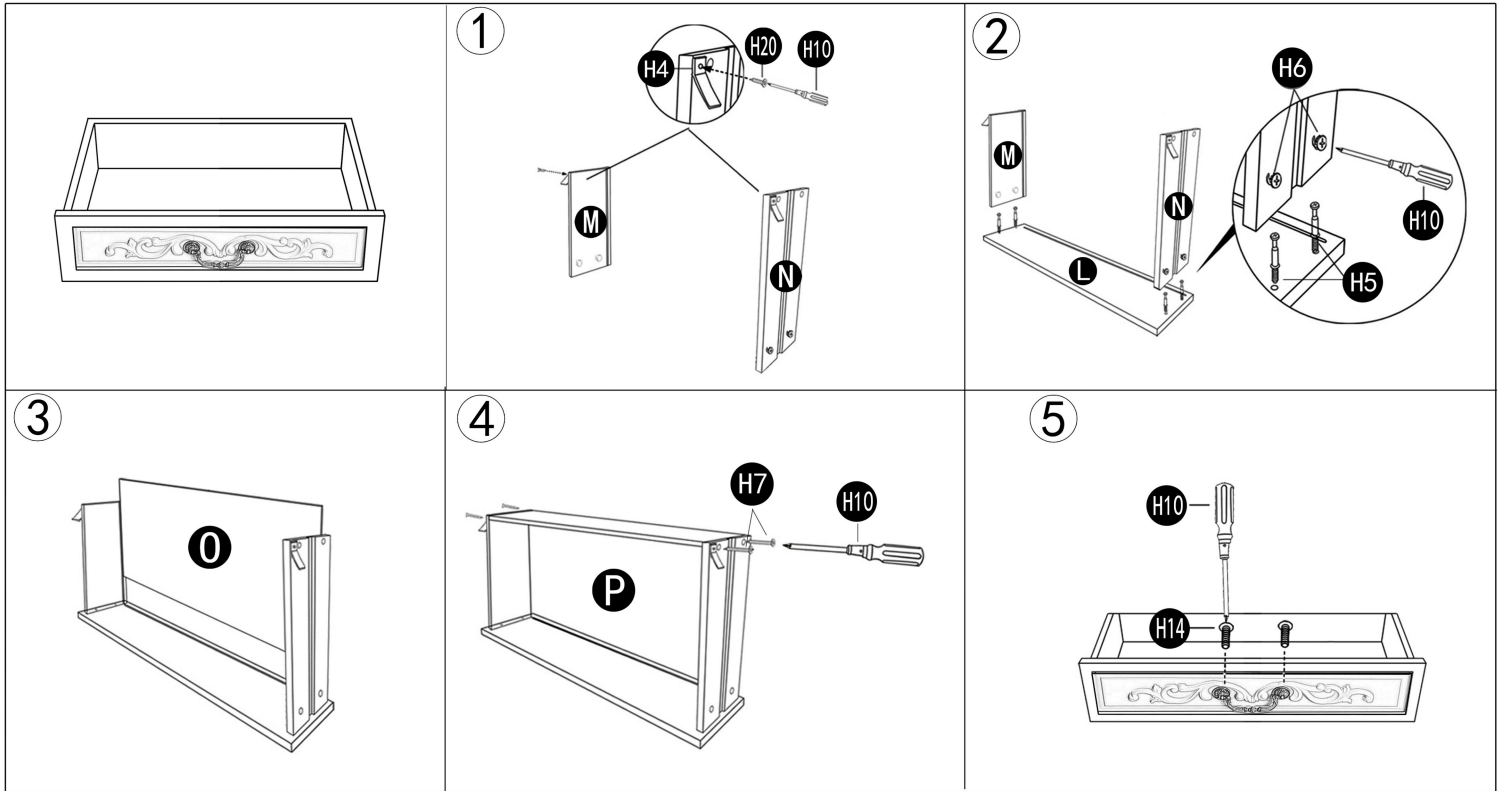

Step 7: Attach (H19) to the back of the main body to enhance the stability with (H21) by Spanner (H10) as shown below.

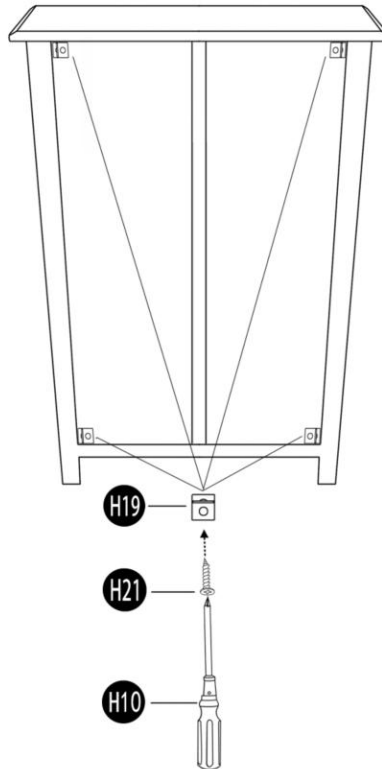

Step 8: Place the drawer to the main Body. Assembly finished.

If you encounter any issues during installation or use, please email us, including your order ID and a detailed description of the problem. If possible, please provide relevant images to expedite assistance. We will strive to resolve any issues promptly.