

Door Mirror

Instruction Manual

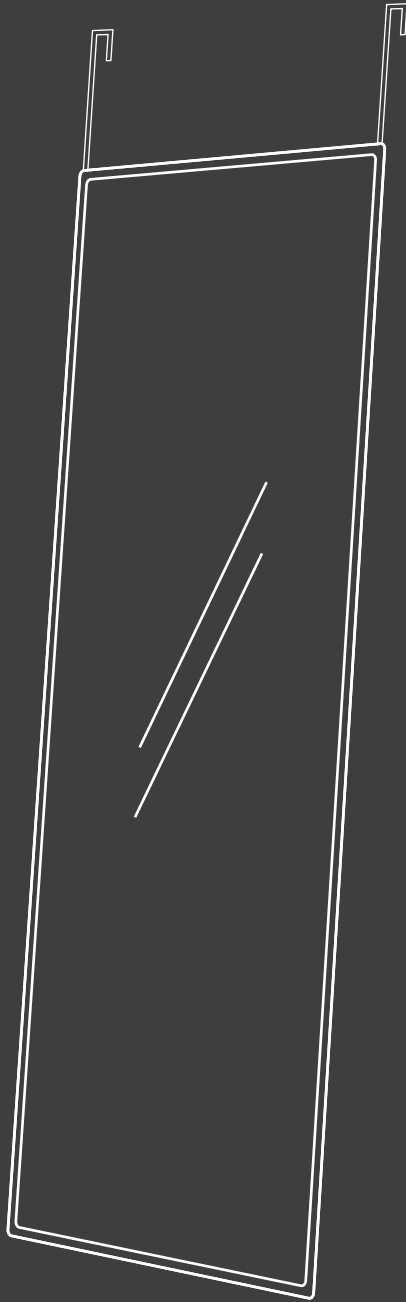

1 Before Assembly

Assembly Tips

- Check the list of contents before assembly to ensure that all parts are included in the package.
- Make sure the wall can bear the weight of the mirror.
- Do not use string or chain to hang the mirror.

Care Advice

- Before using, clean with warm water and a soft, lint-free cloth.
- Check all the screws and bolts are tight every three months or as needed.
- Clean with an ammonia-free glass cleaner or detergent.
- Avoid spraying cleaners directly onto the mirror.

Note: This product contains fragile glass. Do not knock or squeeze it.

Disclaimer



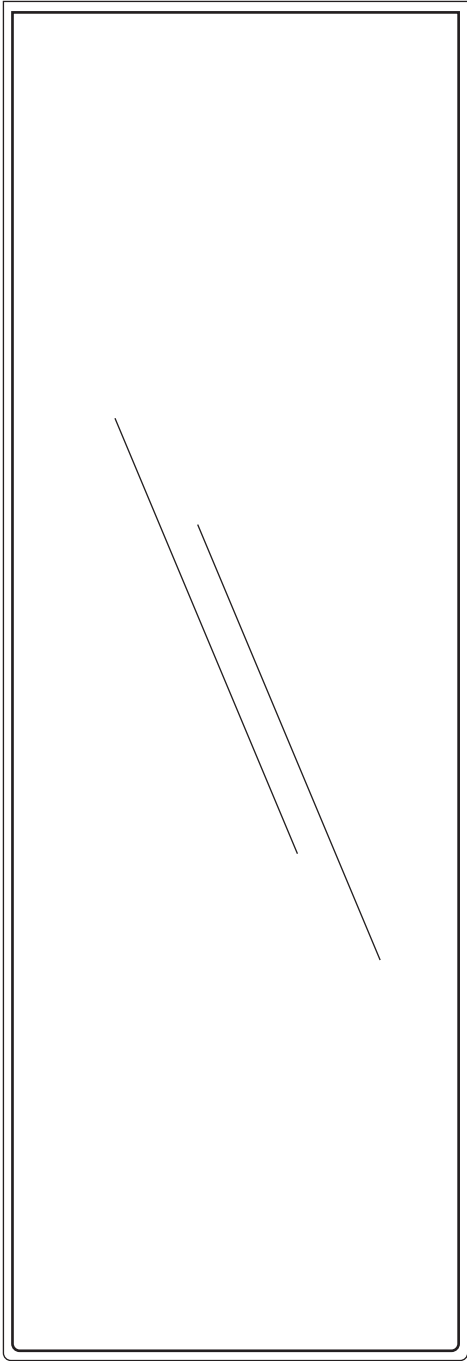

This product contains fragile glass components. Keep children away during installation. Mishandling may result in damage or personal injury. Before use, please note that our company shall not be held liable for any injuries or damages caused by improper use.

If you experience any issues with the product, please contact our after-sales service.

2 Package Contents

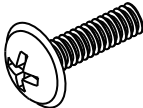

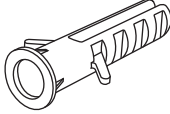
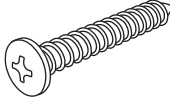
Mirror
x1

 Screws x4	
 Wall Anchor x2	
 Screws x2	
 Bumper Pad x2	

Tools Required (Not Provided)



3 Installation Guide

Choose one of the following installation methods according to your preference.

① Leaning

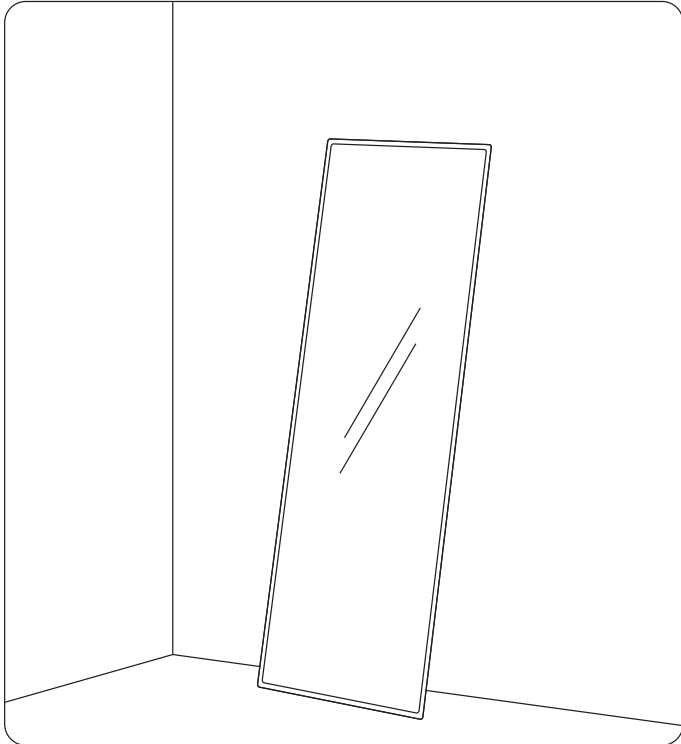

② Over-the-Door Hanging

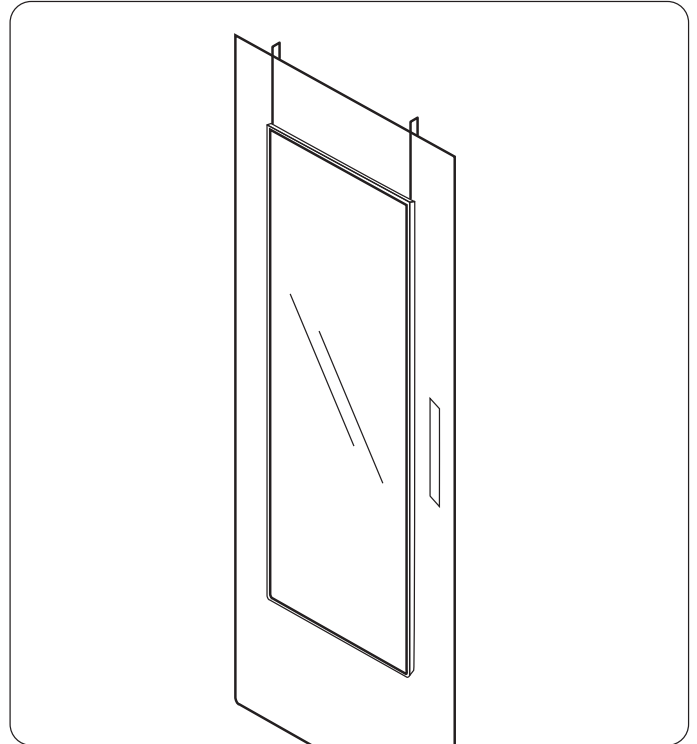

③ Wall Mounting

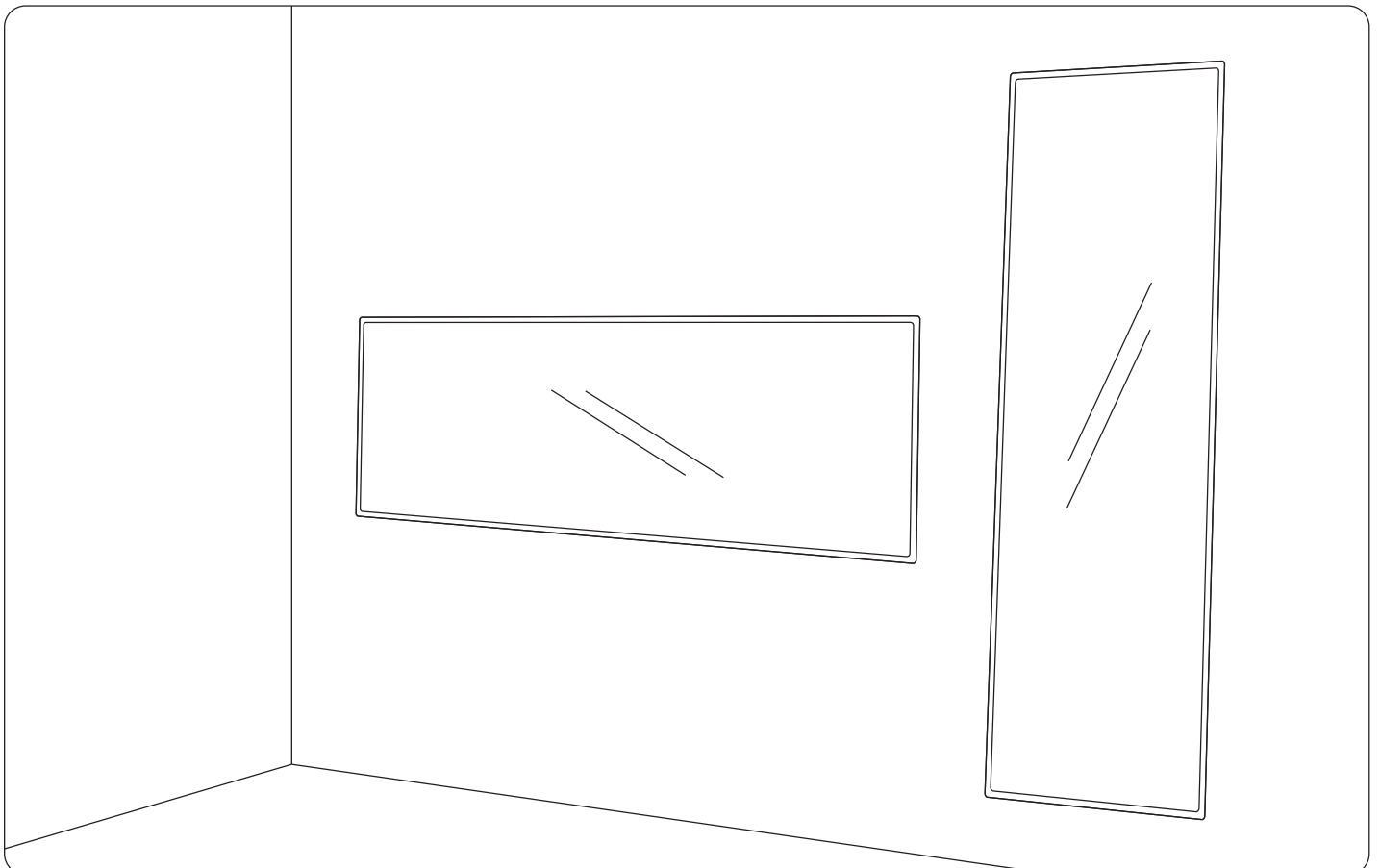

A. Wall Mounting

Step 1



Measure the distance between the two keyhole slots on the back of the mirror and mark the drilling points on the wall.

Step 2

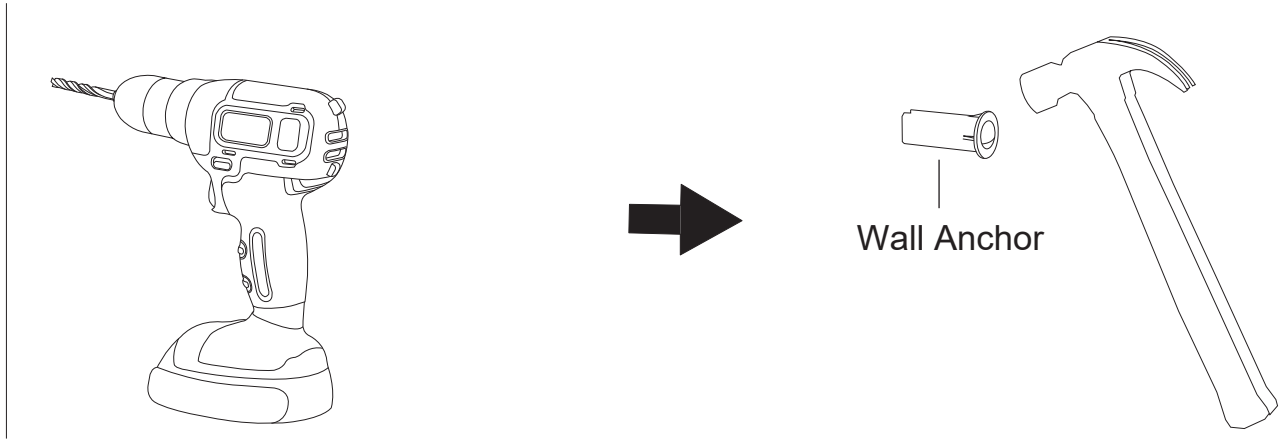

Drill holes at the marked points on the wall. Insert the wall anchors into the holes.

Step 3

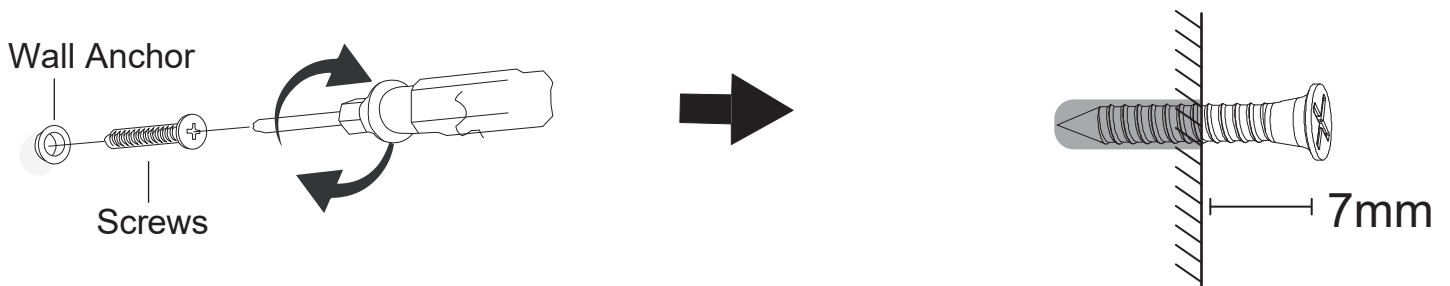

Fasten the screws into the wall anchors, leaving the heads protruding about 7mm.

Step 4

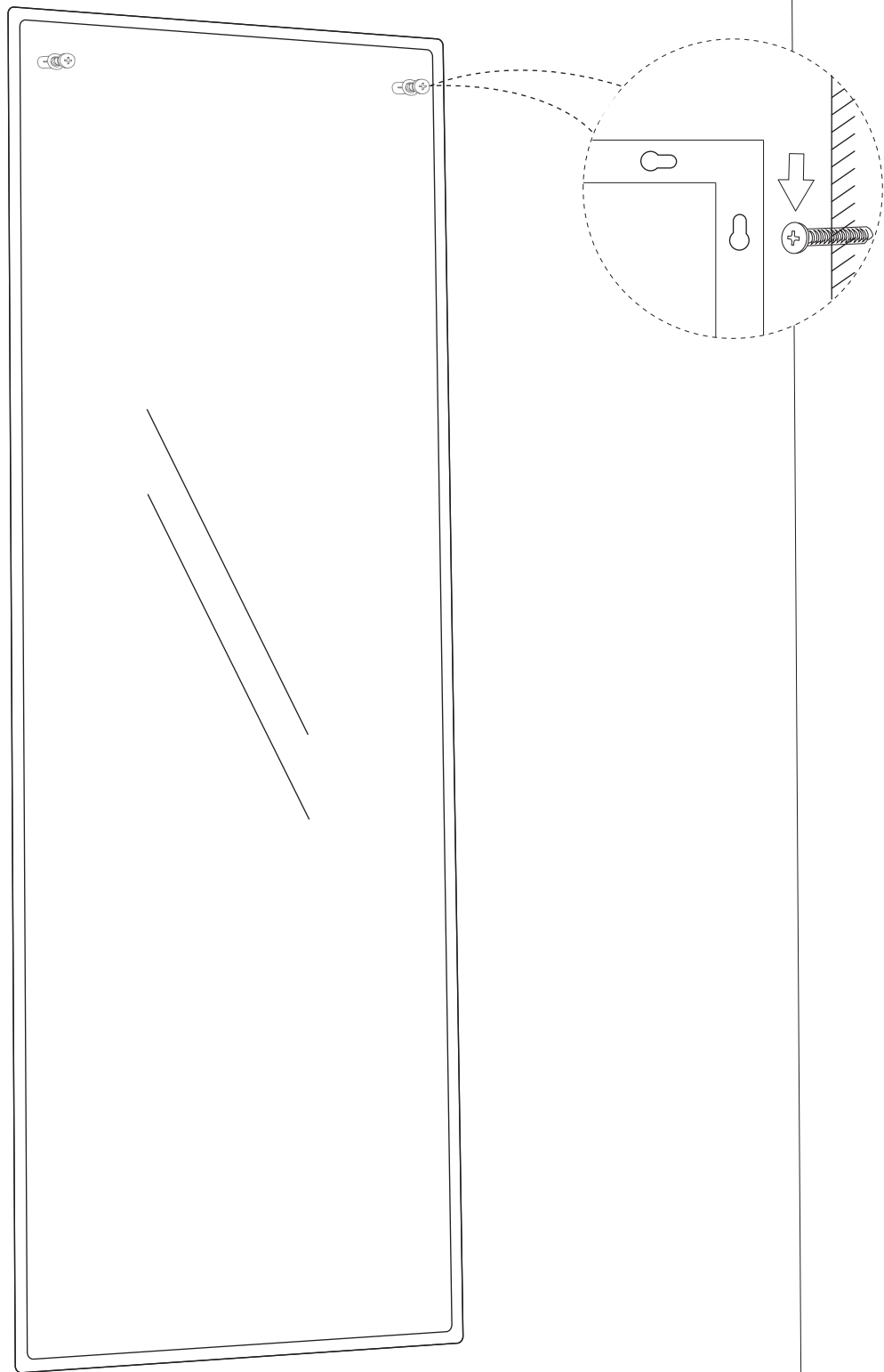

Hang the mirror onto the screw heads through the keyhole slots.

B. Over-the-Door Hanging

Step 1

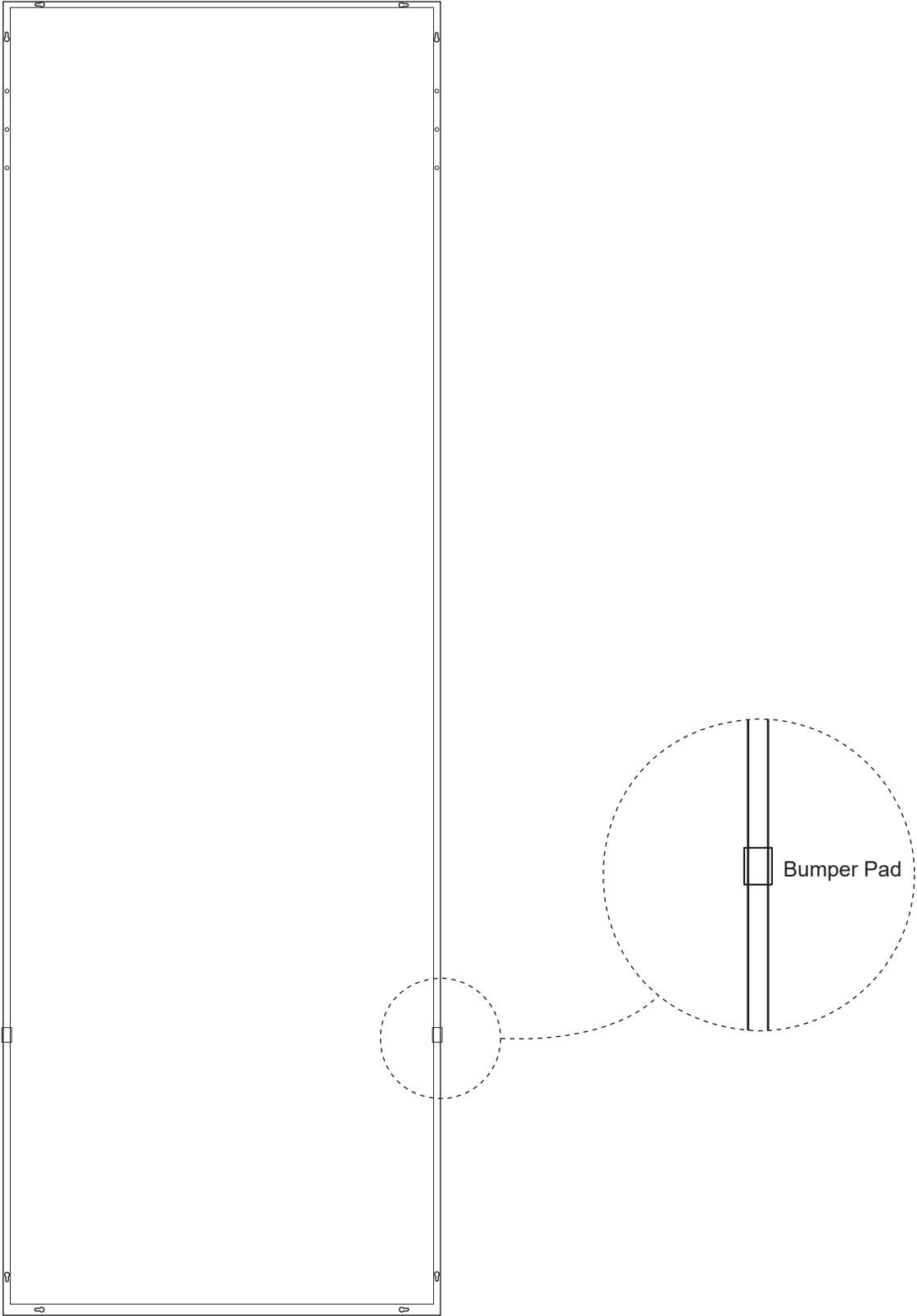

Step 2

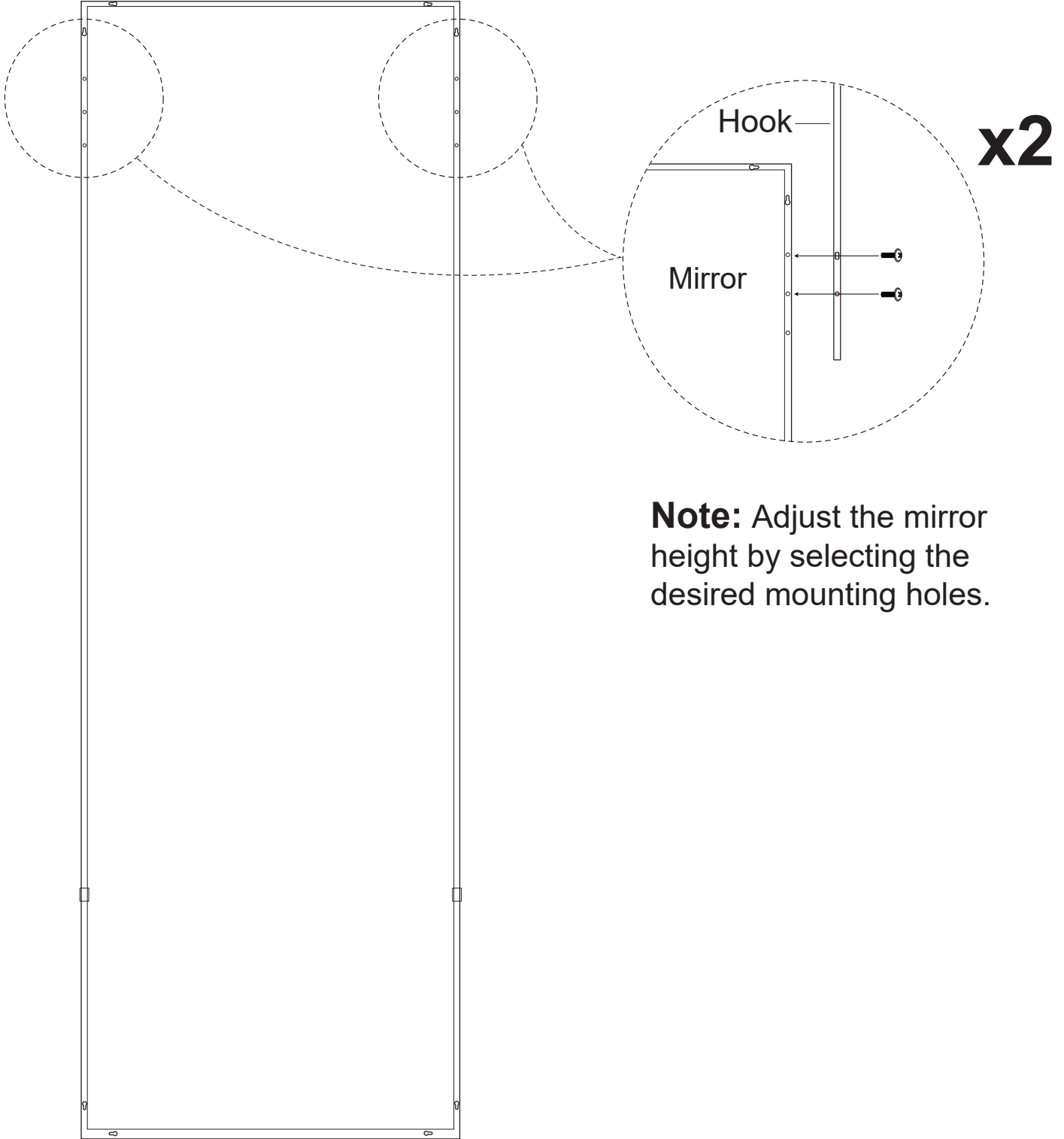

Note: Adjust the mirror height by selecting the desired mounting holes.

Step 3

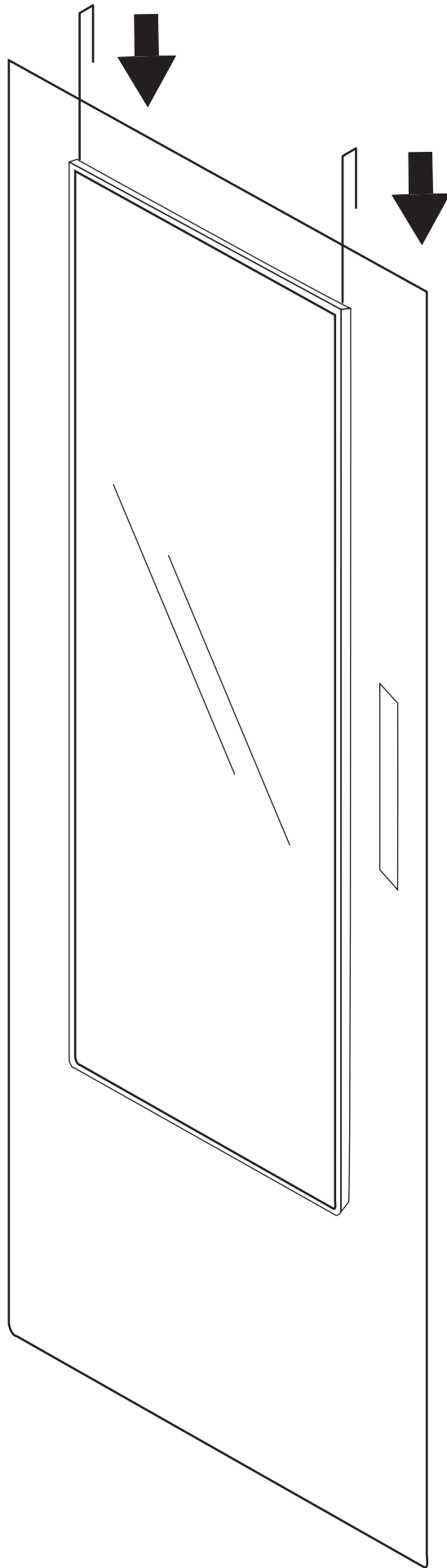

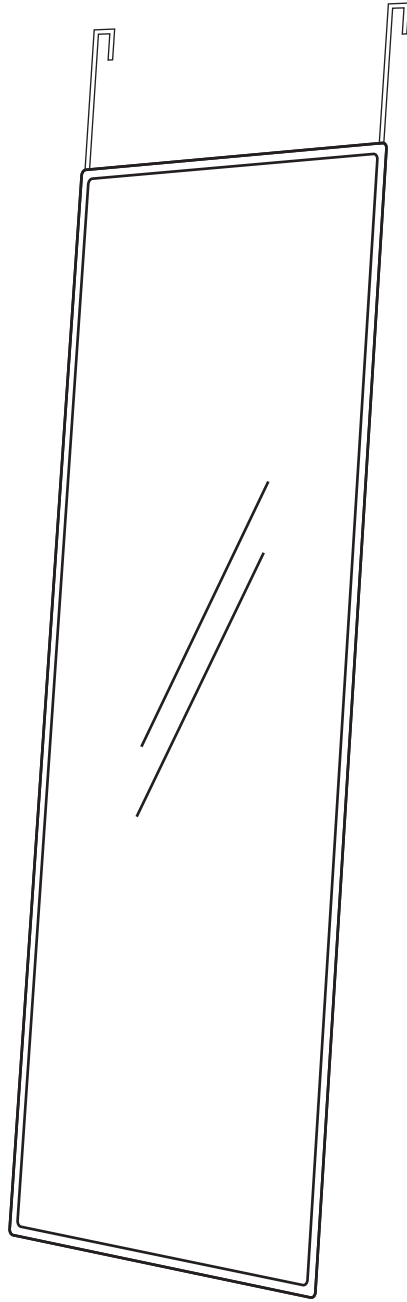

Thank you for choosing this product. We strive to provide you with the best quality products and service in the industry. Should you have any issues, please don't hesitate to contact us.

Espejo de puerta

Manual de instrucciones



1 Antes del montaje

Consejos de montaje

- Compruebe la lista de contenidos antes del montaje para asegurarse de que todas las piezas estén incluidas en el paquete.
- Asegúrese de que la pared pueda soportar el peso del espejo.
- No utilice cuerdas ni cadenas para colgar el espejo.

Consejos de cuidado

- Antes de usarlo, límpielo con agua tibia y un paño suave y sin pelusa.
- Compruebe que todos los tornillos y pernos estén apretados cada tres meses o cuando sea necesario.
- Límpielo con un limpiacristales o detergente sin amoníaco.
- Evite rociar limpiadores directamente sobre el espejo.

Nota: Este producto contiene vidrio frágil. No lo golpee ni lo presione.

Descargo de responsabilidad

Este producto contiene componentes de vidrio frágil. Mantenga a los niños alejados durante la instalación. Un manejo incorrecto puede provocar daños o lesiones personales. Antes de usarlo, tenga en cuenta que nuestra empresa no se hace responsable de lesiones ni daños derivados de un uso indebido.

Si tiene algún problema con el producto, póngase en contacto con nuestro servicio posventa.

2 Lista de contenidos

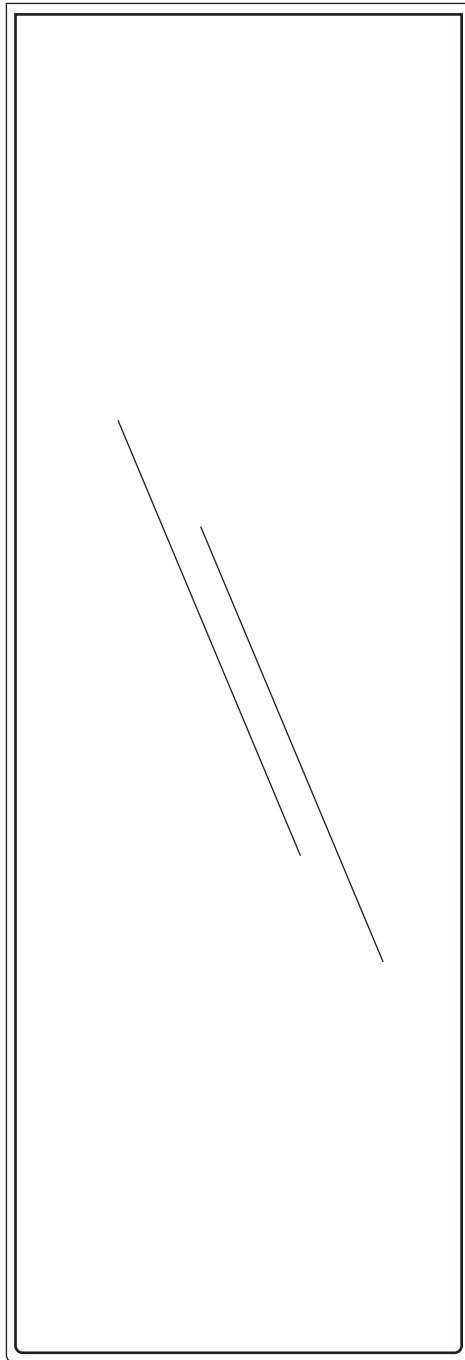

Espejo
x1

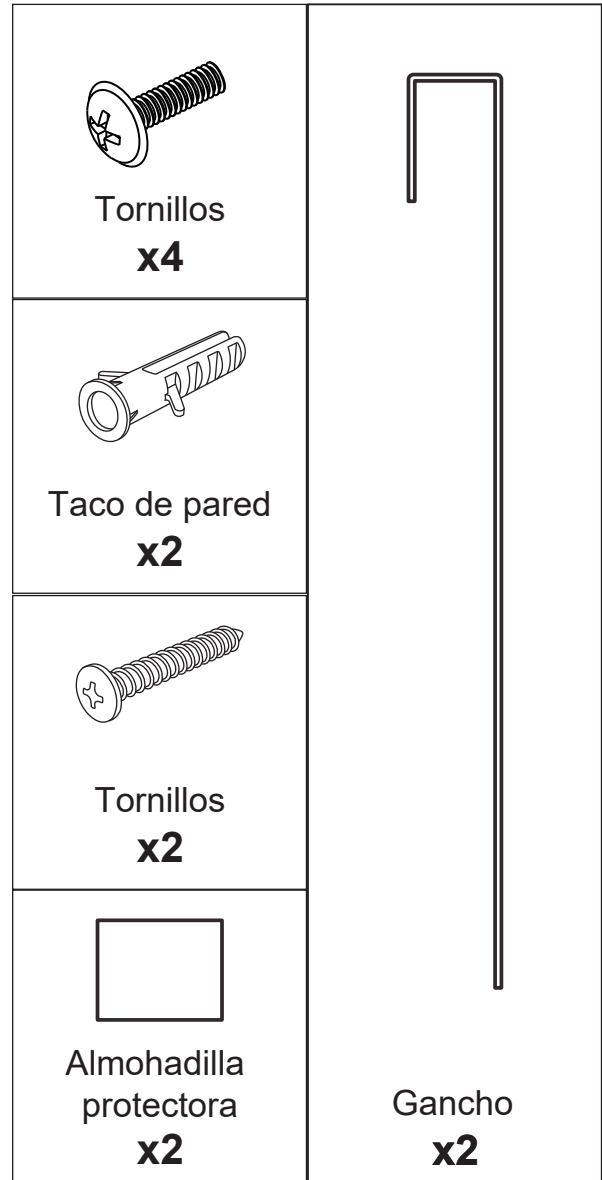

Herramientas necesarias (no incluidas)



3 Guía de instalación

Elija uno de los siguientes métodos de instalación según sus preferencias.

① Apoyado

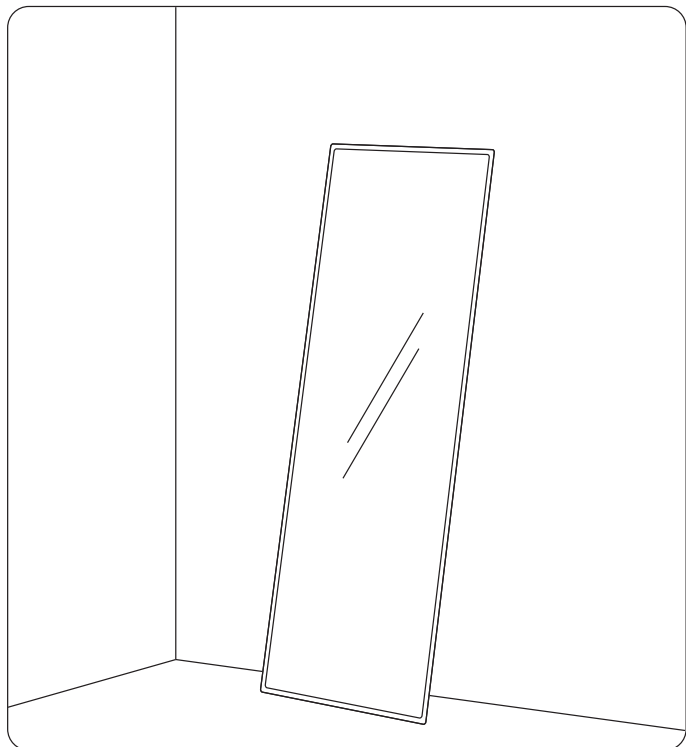

② Colgado sobre la puerta

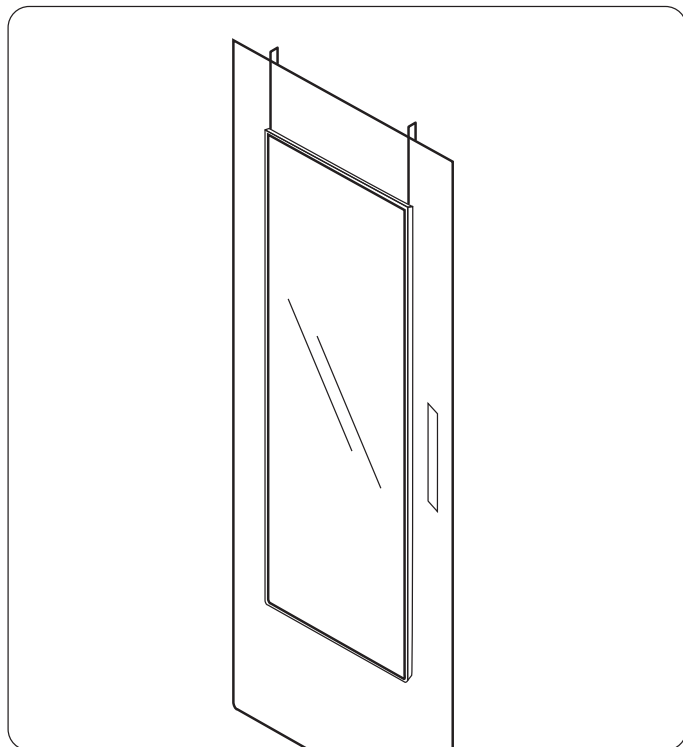

③ Montaje en pared

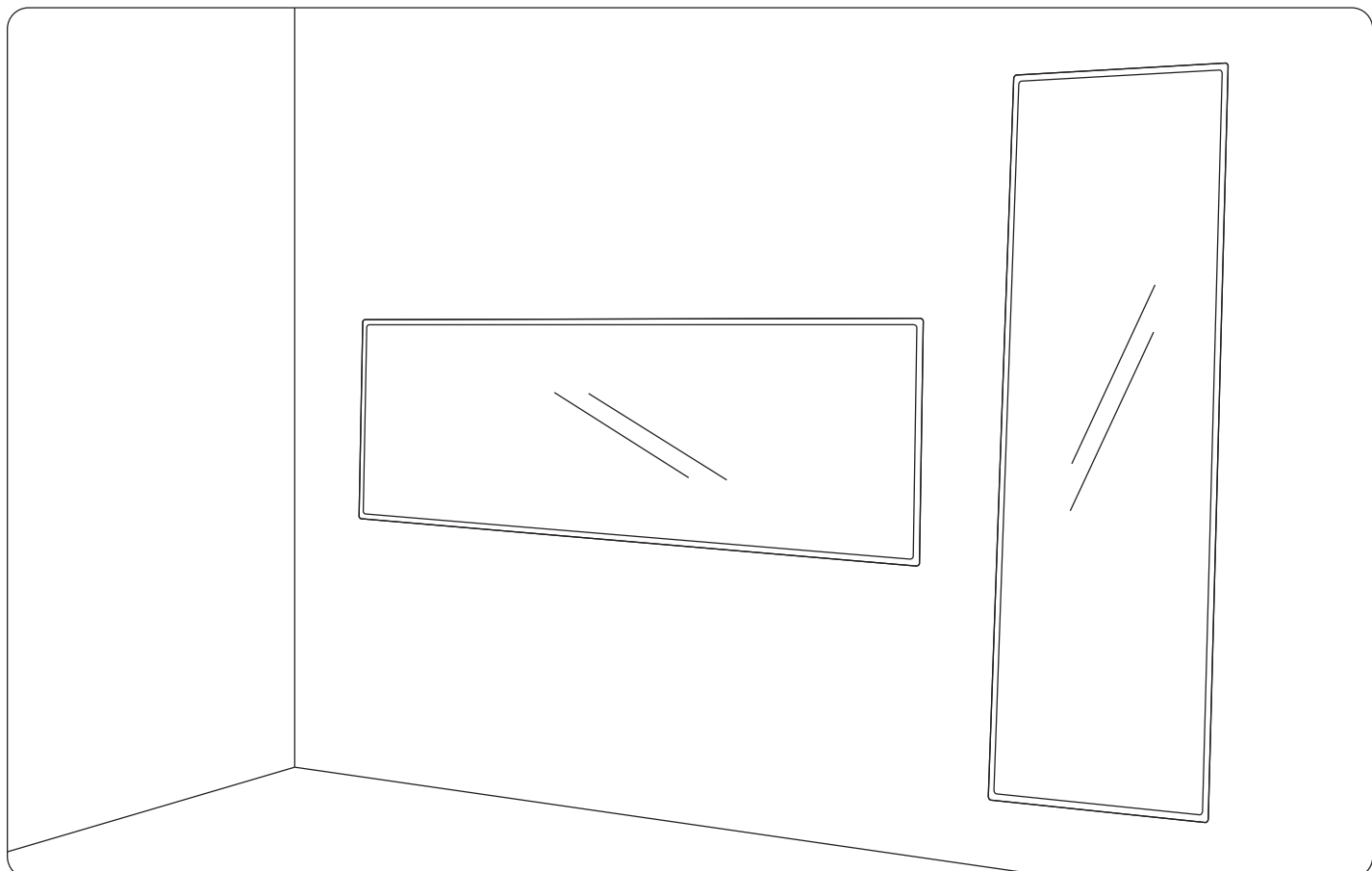

A. Montaje en pared

Paso 1

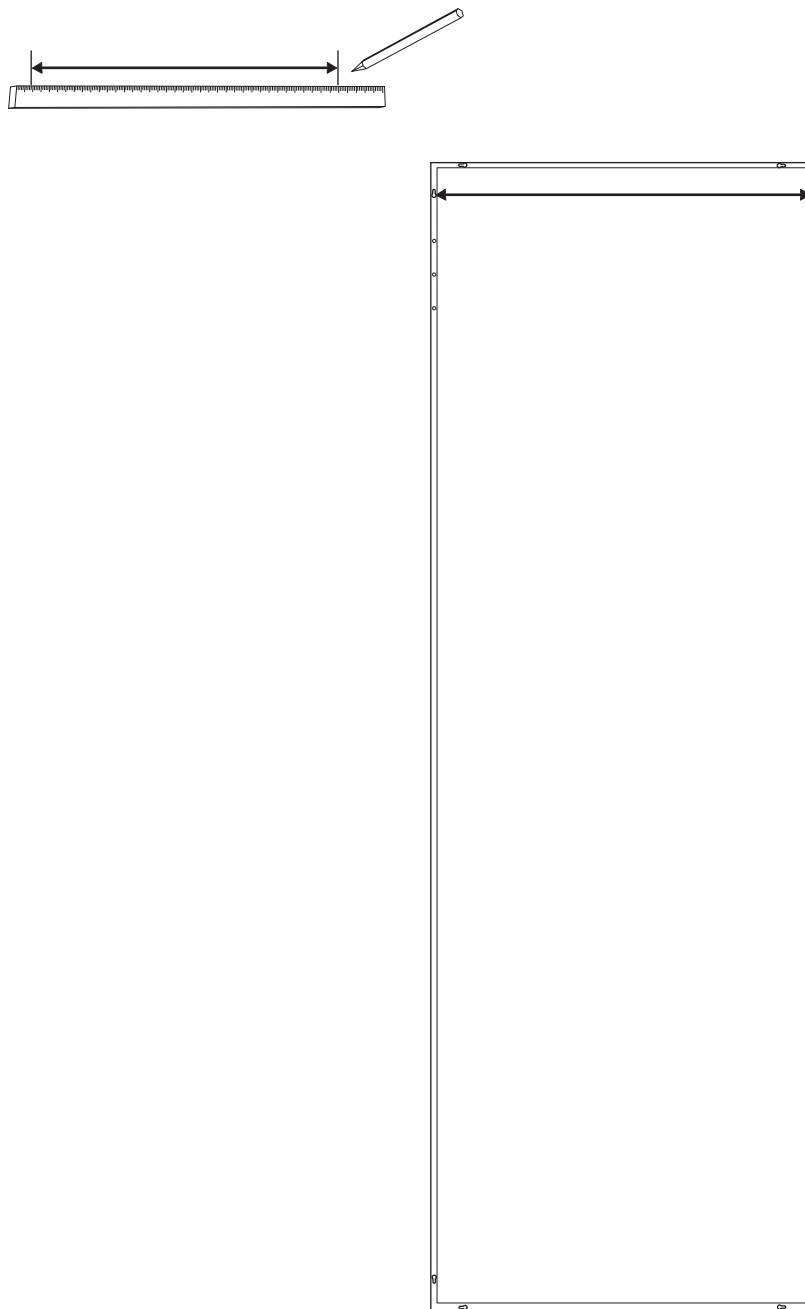

Mida la distancia entre las dos ranuras tipo ojo de cerradura en la parte trasera del espejo y marque en la pared los puntos de taladrado.

Paso 2

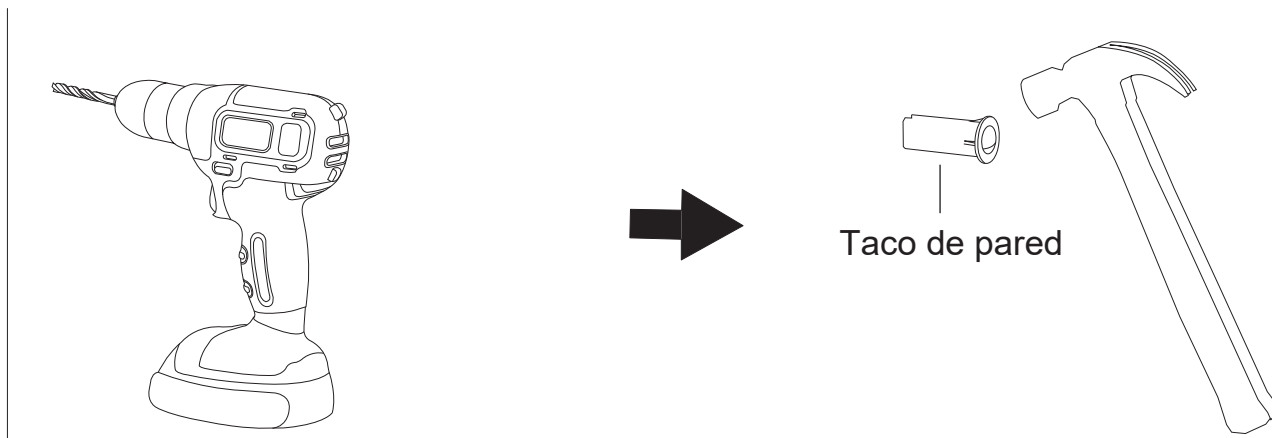

Taladre los orificios en los puntos marcados de la pared. Introduzca los tacos de pared en los orificios.

Paso 3

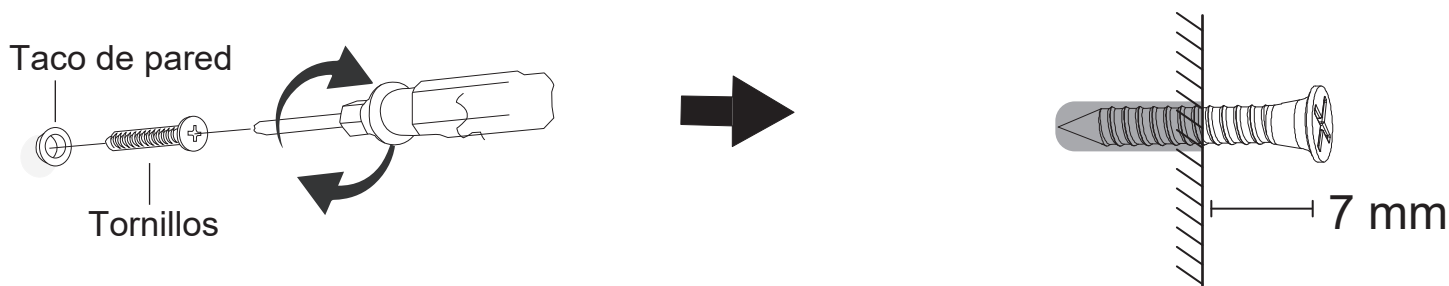

Atornille los tornillos en los tacos dejando sobresalir las cabezas unos 7 mm.

Paso 4

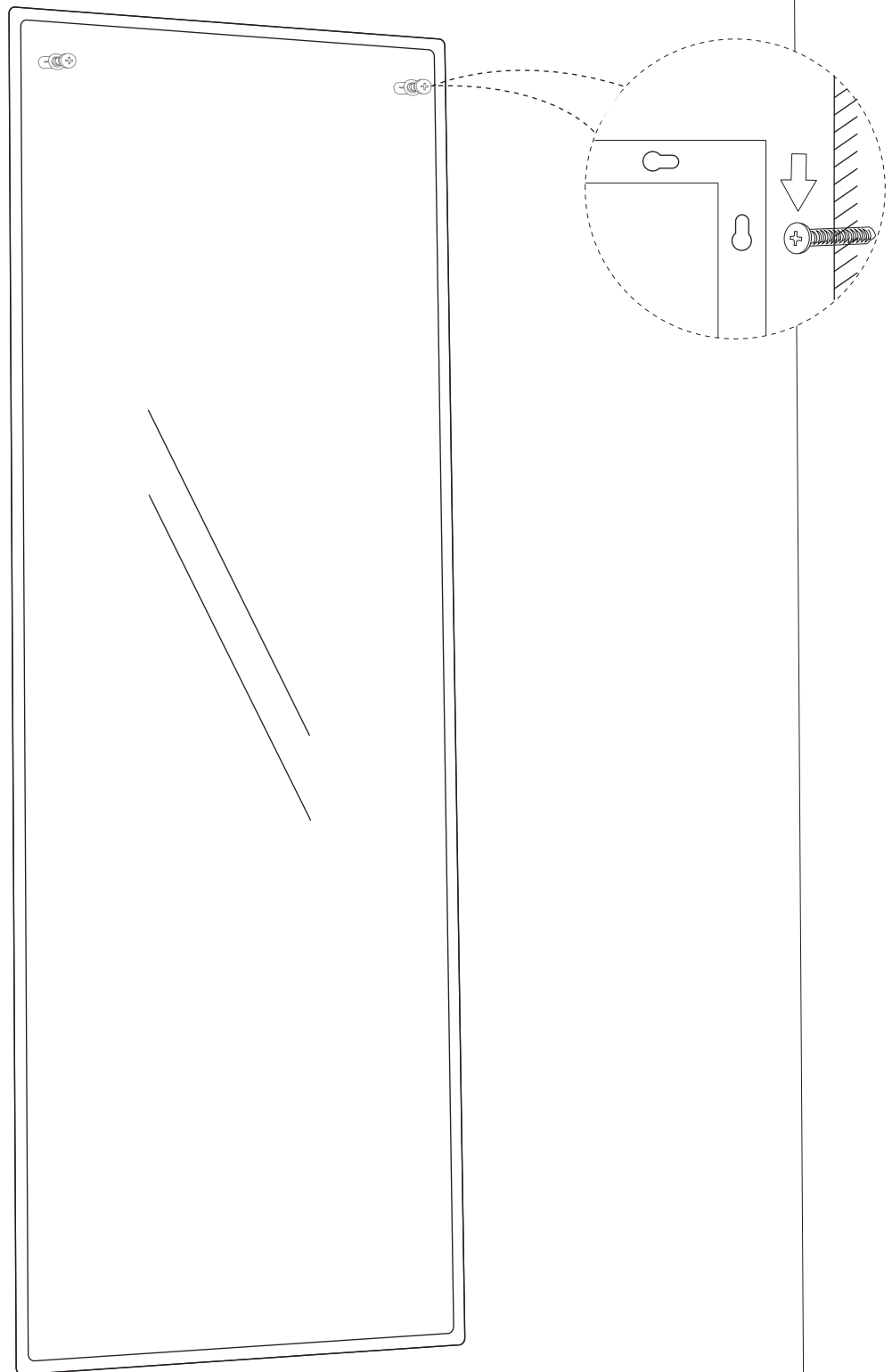

Cuelgue el espejo en las cabezas de los tornillos a través de las ranuras tipo ojo de cerradura.

B. Colgado sobre la puerta

Paso 1

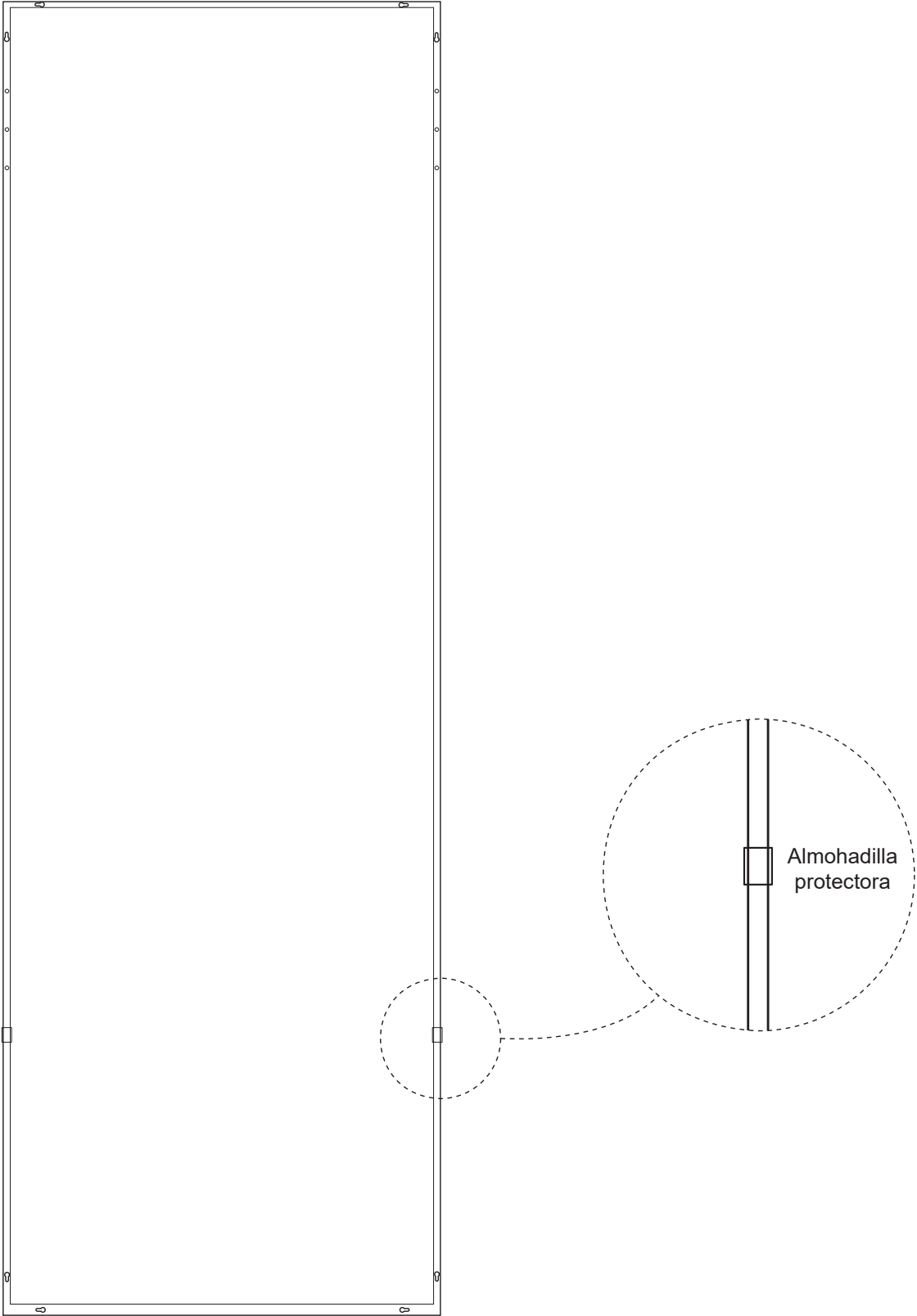

Paso 2

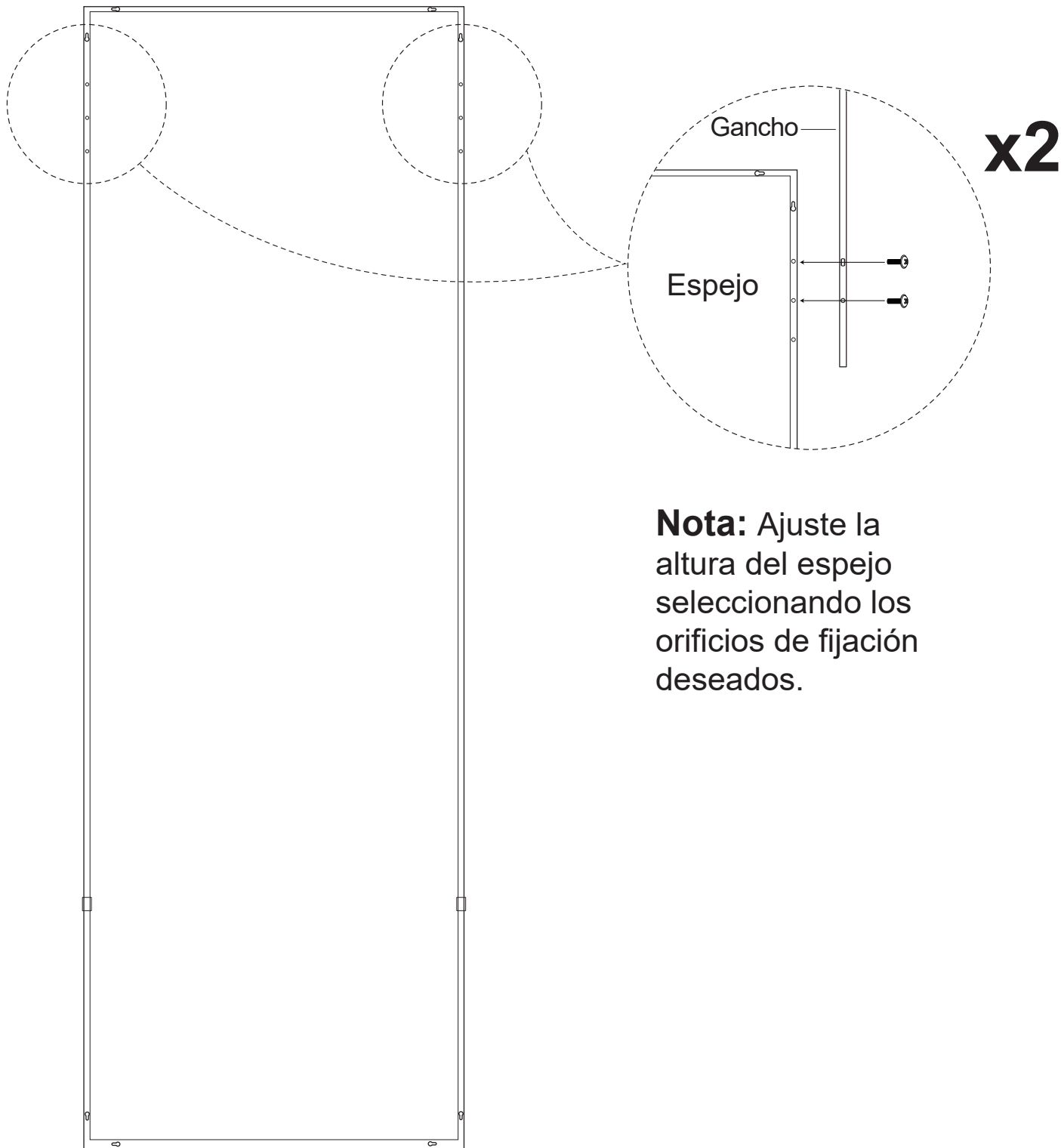

Nota: Ajuste la altura del espejo seleccionando los orificios de fijación deseados.

Paso 3

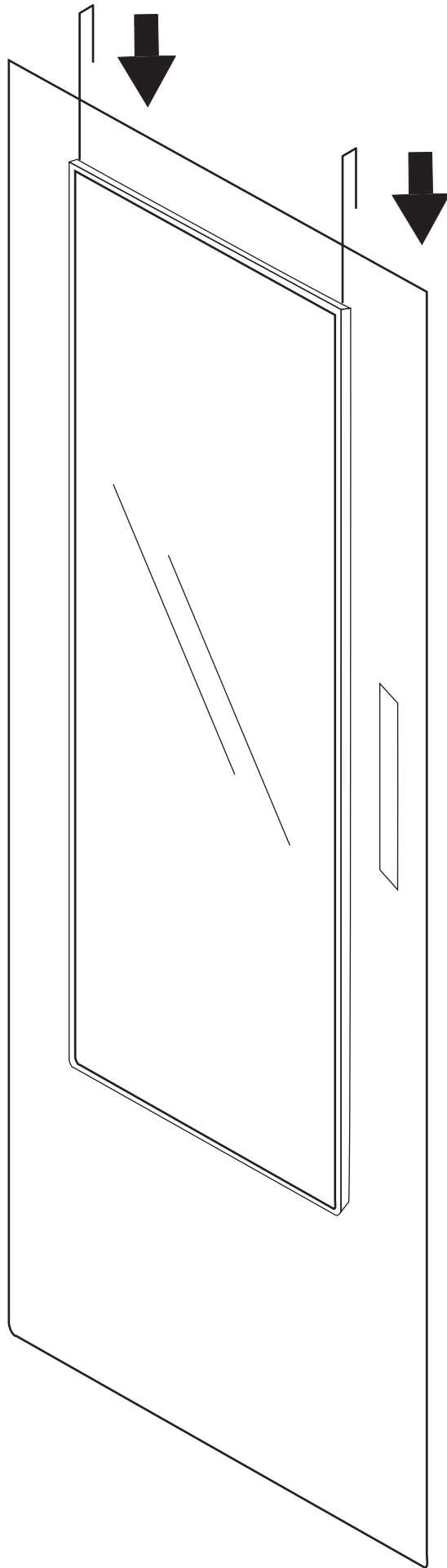

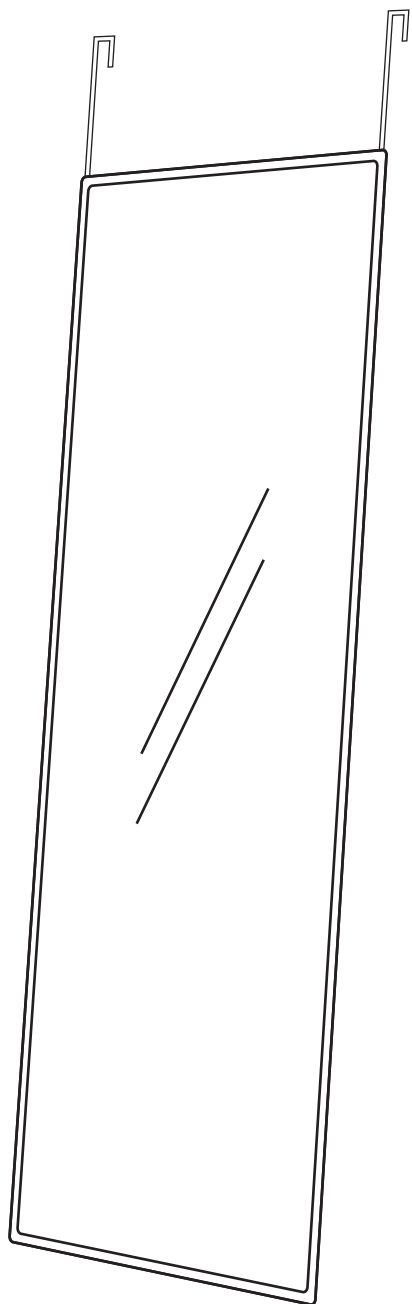

Le agradecemos por haber elegido este producto. Nos esforzamos por ofrecerle productos y servicios de la más alta calidad en el sector. Si tiene algún problema, no dude en ponerse en contacto con nosotros.

Miroir de porte

Manuel d'instructions



1 Avant l'Assemblage

Conseils pour l'Assemblage

- Vérifiez la liste des contenus avant l'assemblage pour vous assurer que toutes les pièces sont incluses dans l'emballage.
- Assurez-vous que le mur peut supporter le poids du miroir.
- N'utilisez pas de cordon ou de chaîne pour suspendre le mirror.

Conseils d'Entretien

- Avant utilisation, nettoyez avec de l'eau tiède et un chiffon doux sans peluches.
- Vérifiez que toutes les vis et boulons sont serrés tous les trois mois ou au besoin.
- Nettoyez avec un nettoyant pour vitres sans ammoniac ou un détergent.
- Évitez de pulvériser des nettoyants directement sur le miroir.

Remarque : Ce produit contient du verre fragile. Ne le cognez pas et ne le compressez pas.

Avis de non-responsabilité

Ce produit contient des composants en verre fragiles. Tenez les enfants à l'écart pendant l'installation. Une mauvaise manipulation peut entraîner des dommages ou des blessures. Veuillez noter avant utilisation que notre société ne saurait être tenue responsable des blessures ou dommages résultant d'une utilisation incorrecte.

Si vous rencontrez un problème avec le produit, veuillez contacter notre service après-vente.

2 Contenu du colis

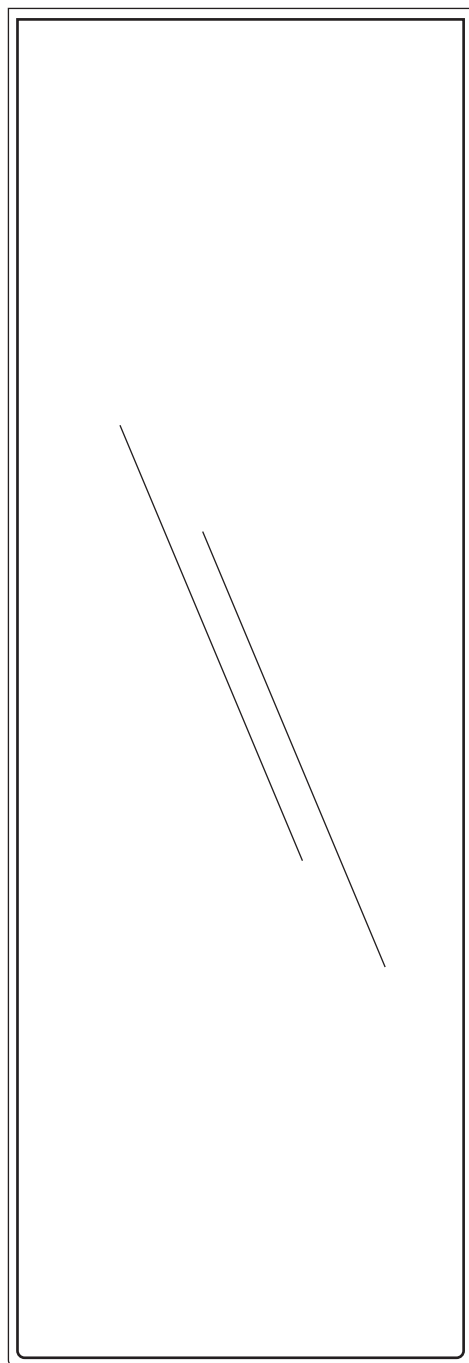

Miroir
x1

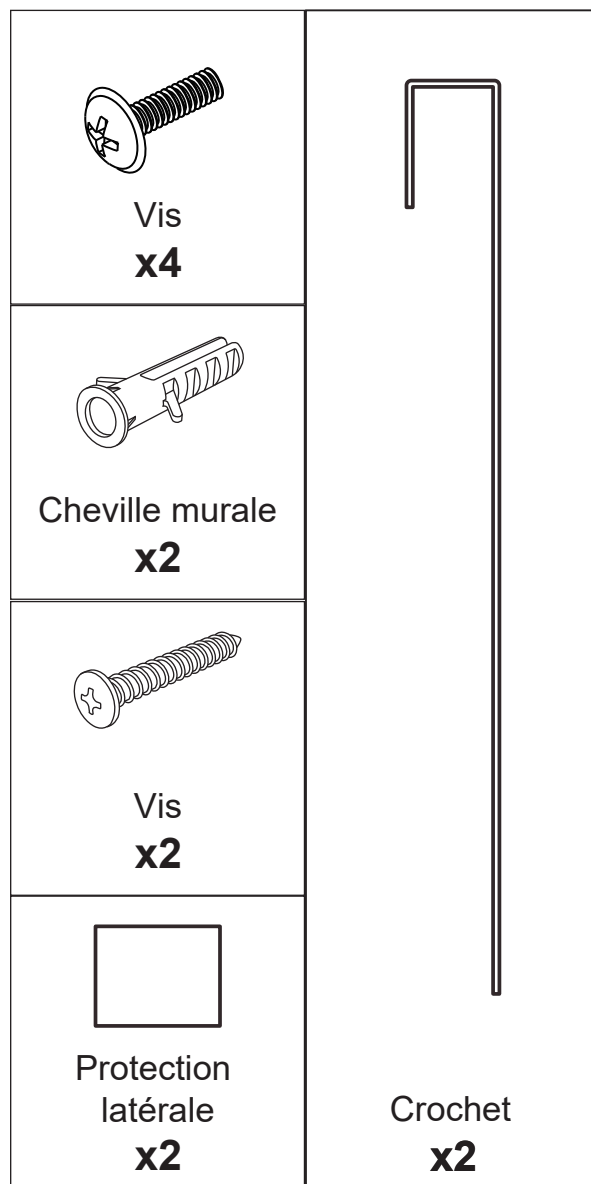

Outils Requis (Non Fournis)

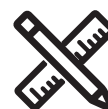

3 Guide d'Installation

Choisissez l'une des méthodes d'installation suivantes selon votre préférence.

① Incliné

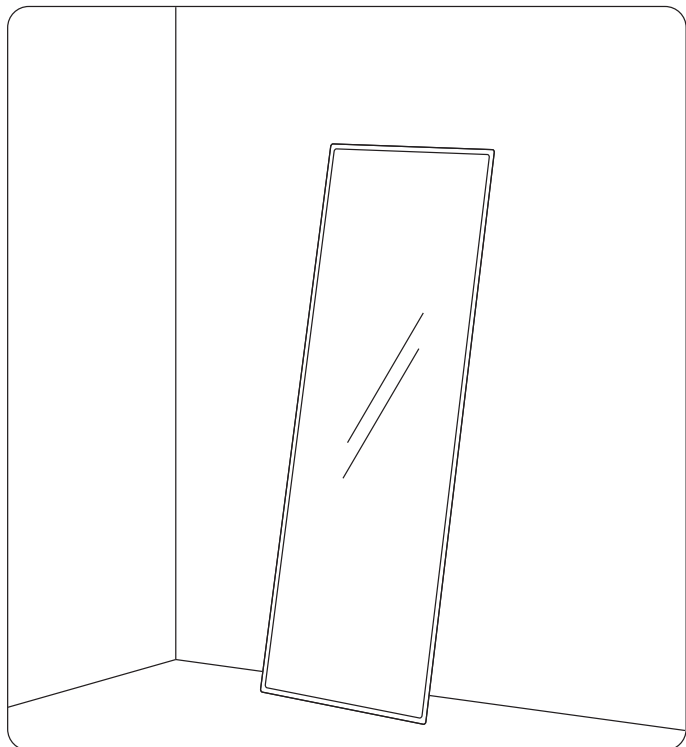

② Accroche-porte

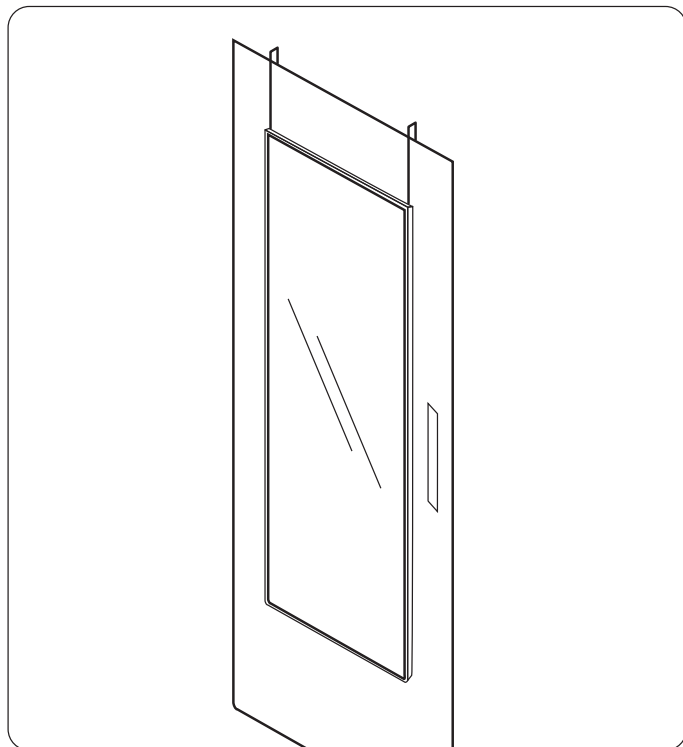

③ Montage mural

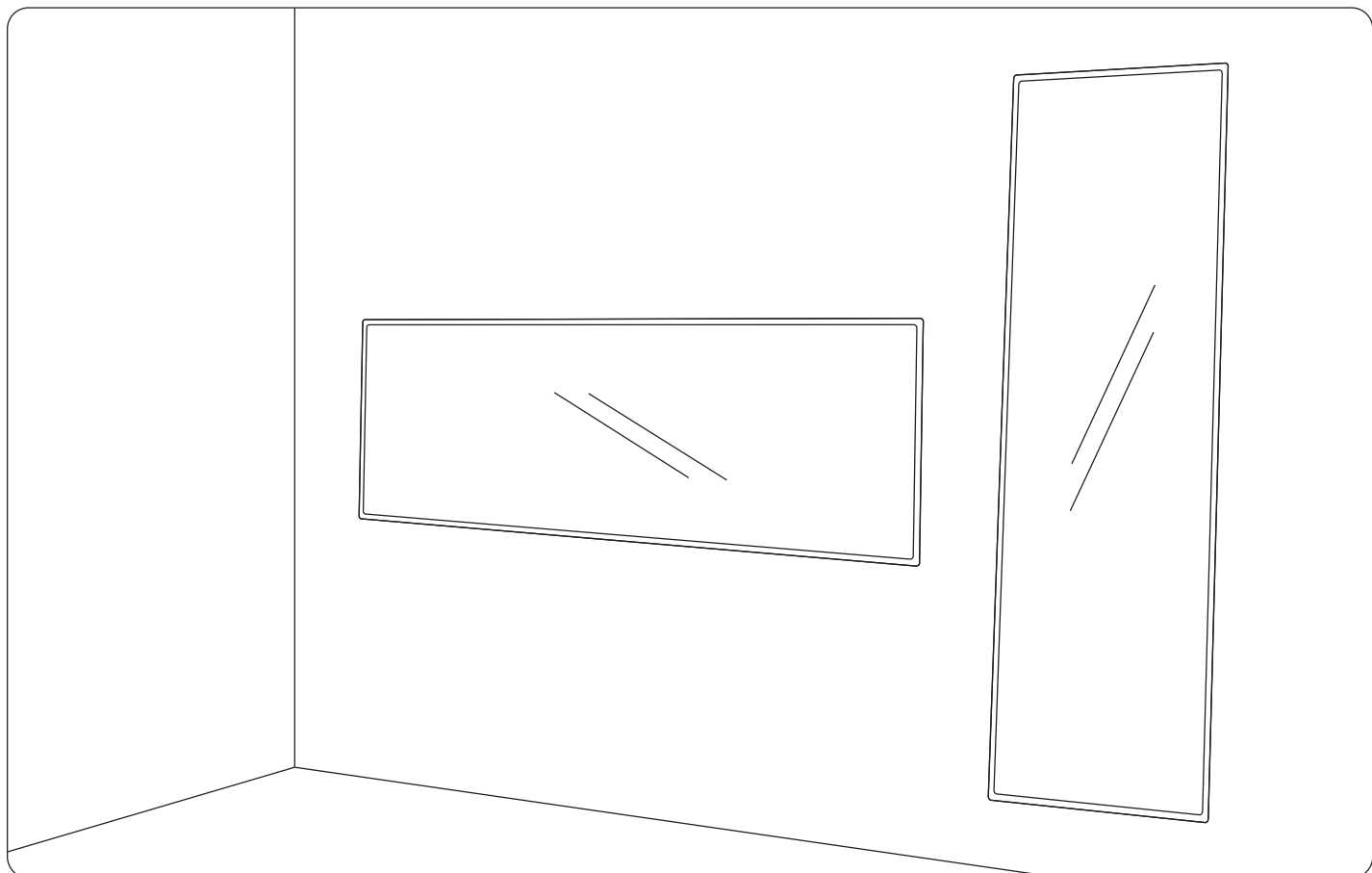

A. Montage mural

Étape 1



Mesurez la distance entre les deux encoches en trou de serrure à l'arrière du miroir et marquez les points de perçage sur le mur.

Étape 2

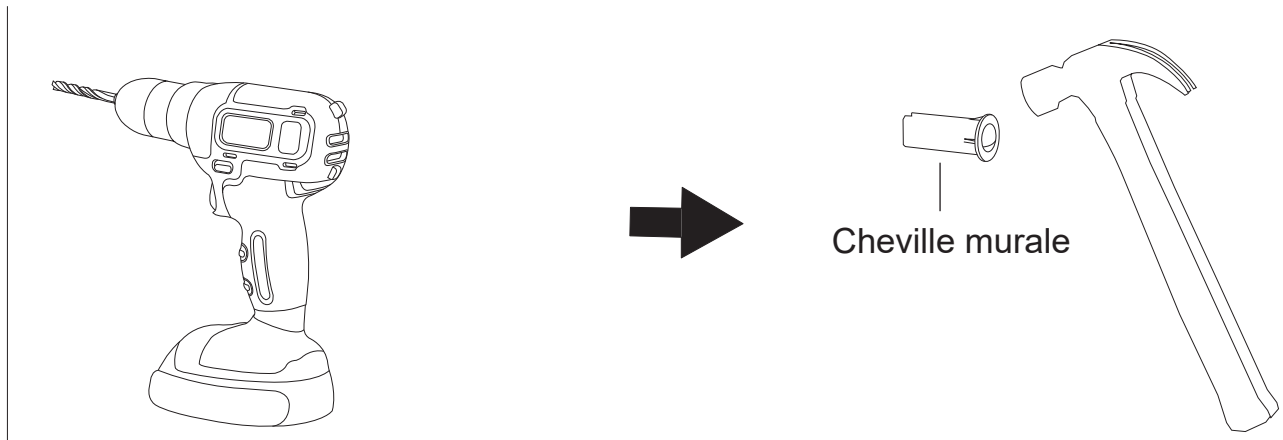

Percez des trous aux points marqués sur le mur. Insérez les chevilles dans les trous.

Étape 3

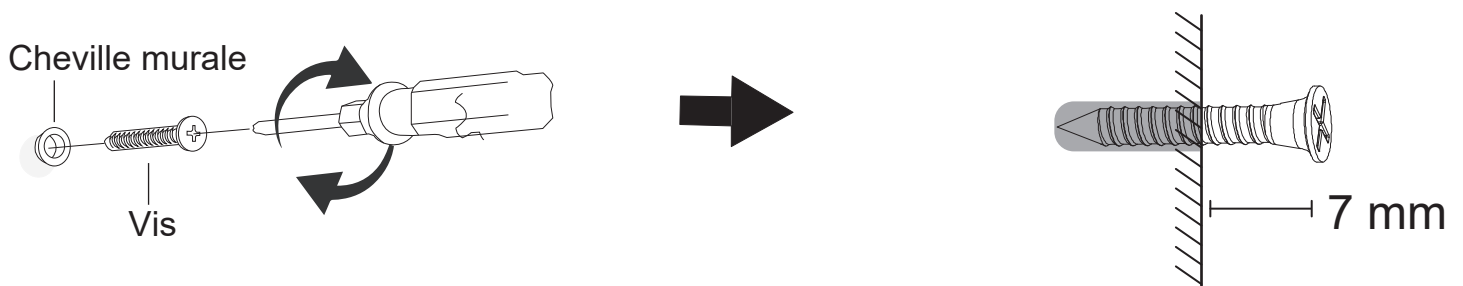

Vissez les chevilles dans le mur en laissant dépasser les têtes d'environ 7 mm.

Étape 4

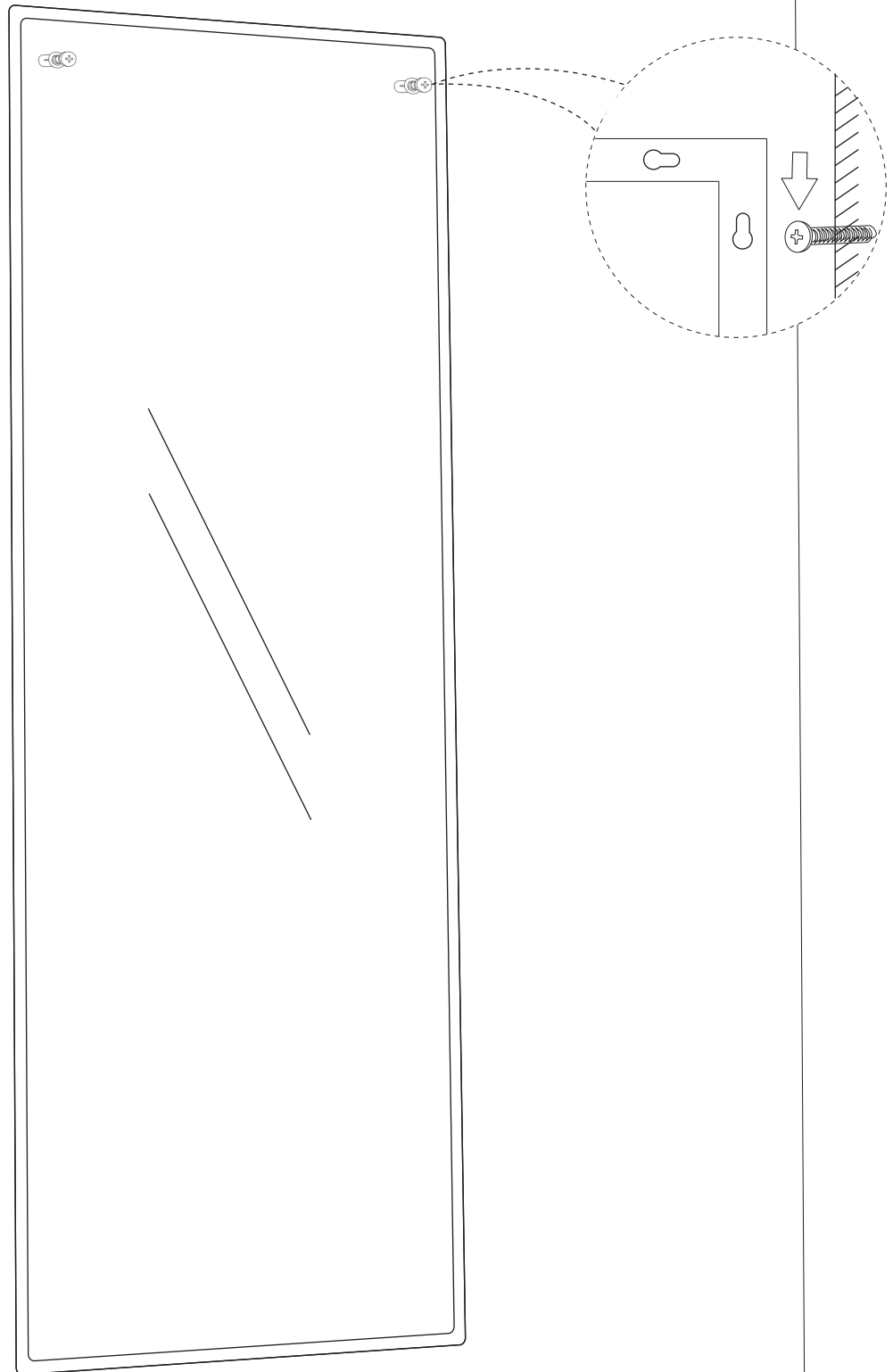

Accrochez le miroir sur les têtes de vis à travers les encoches prévues à cet effet.

B. Accroche-porte

Étape 1

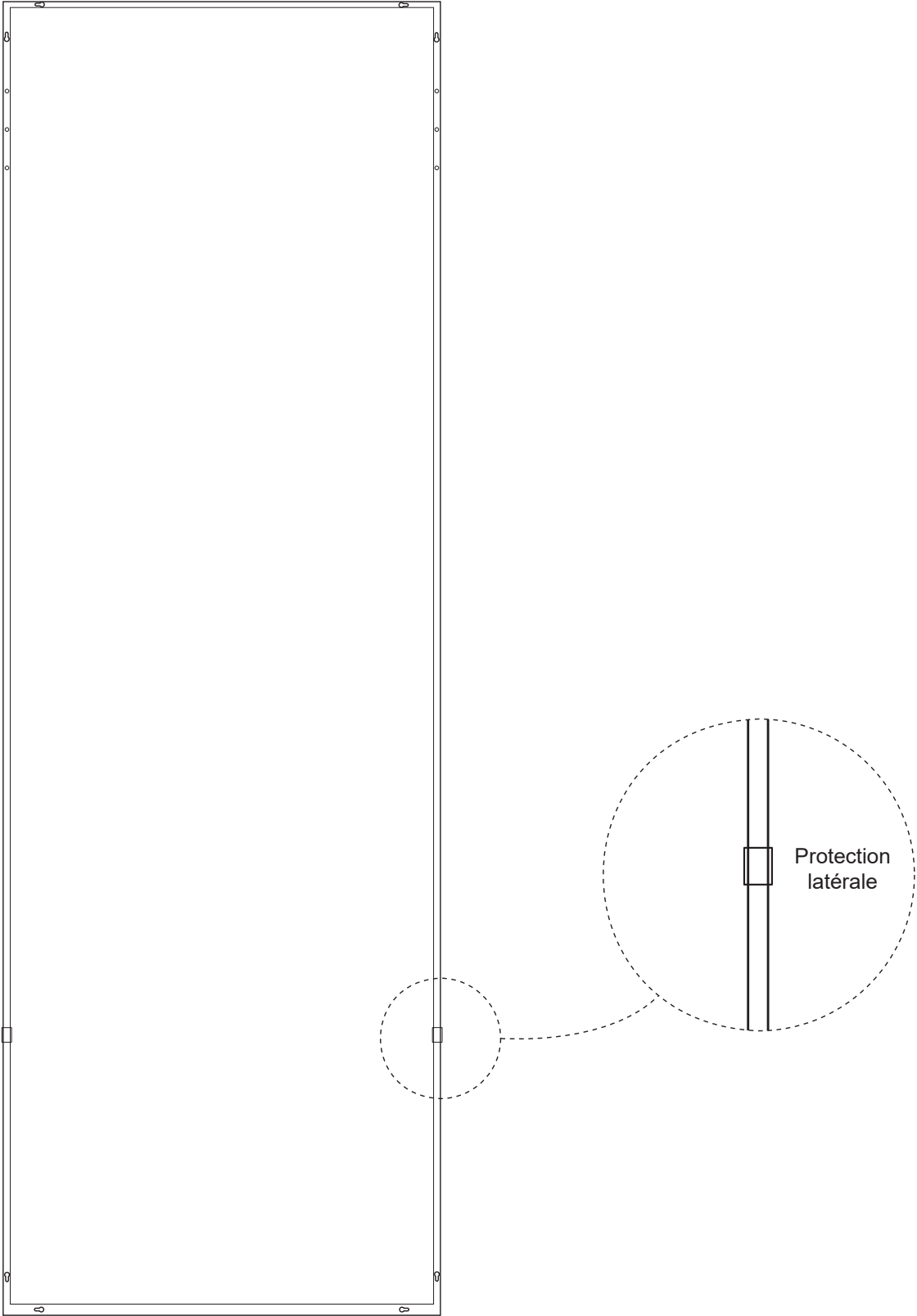

Étape 2

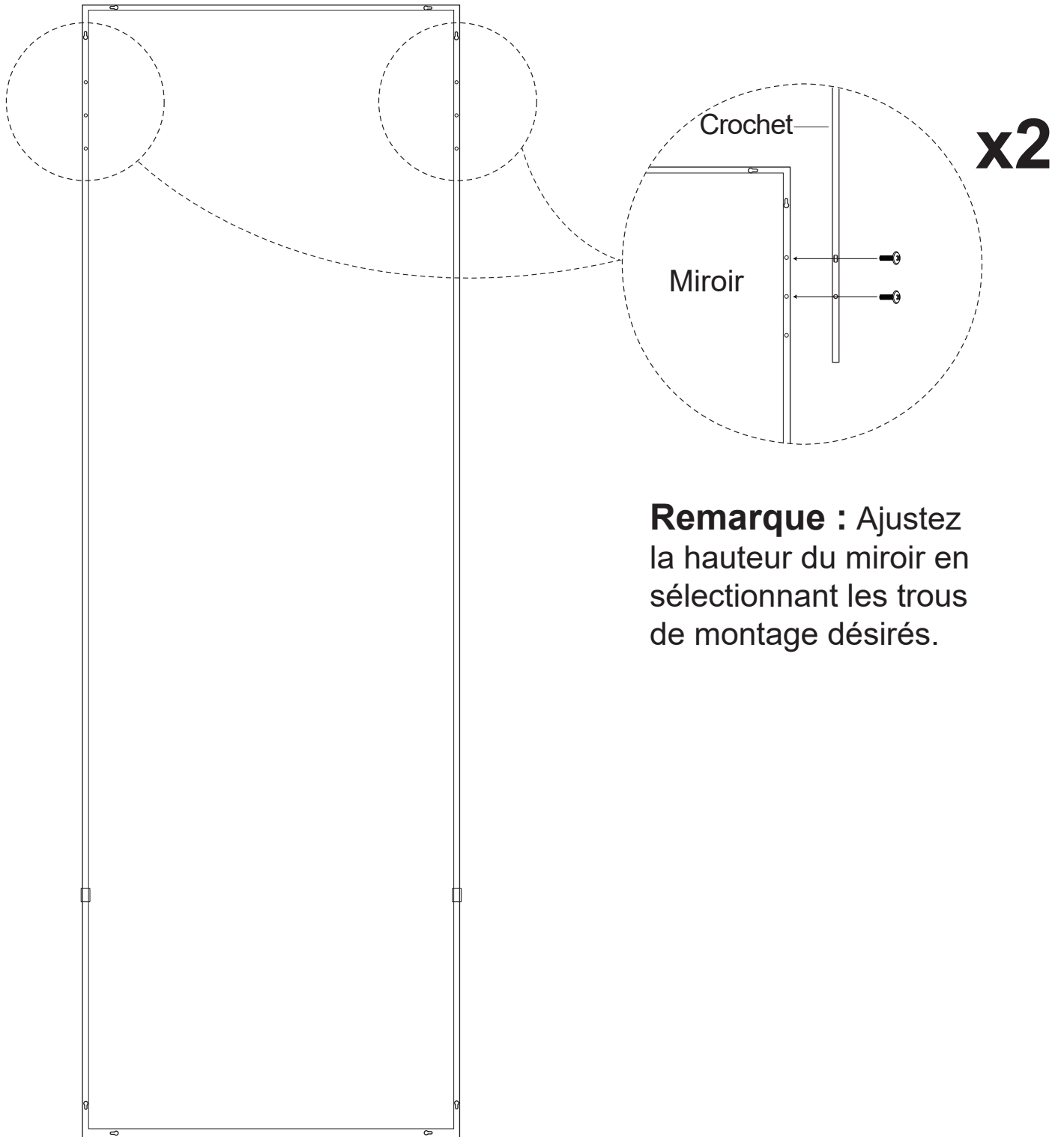

Étape 3

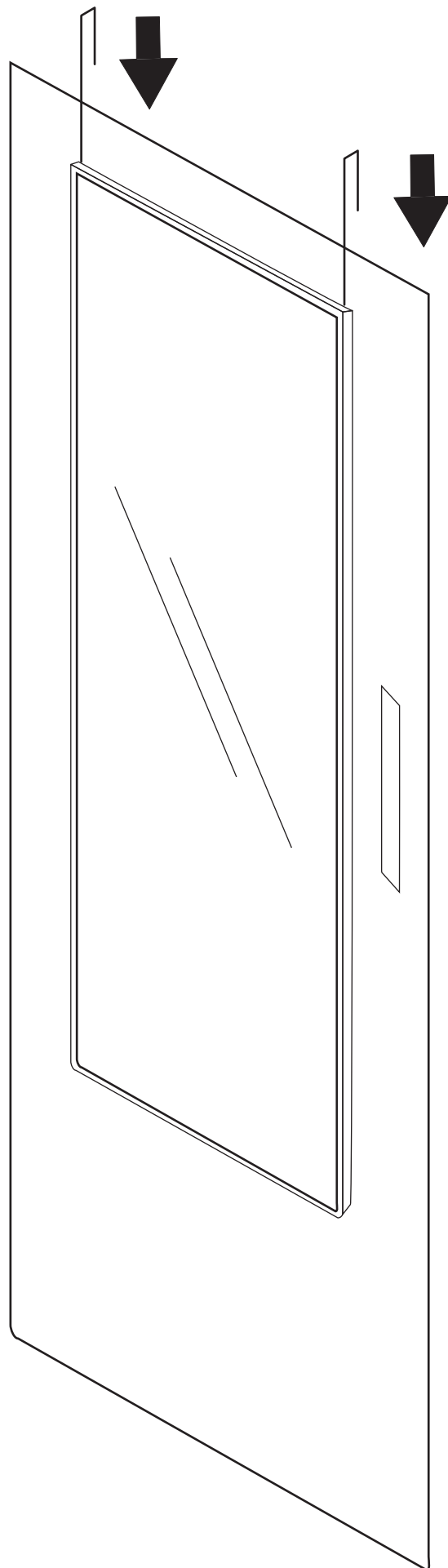

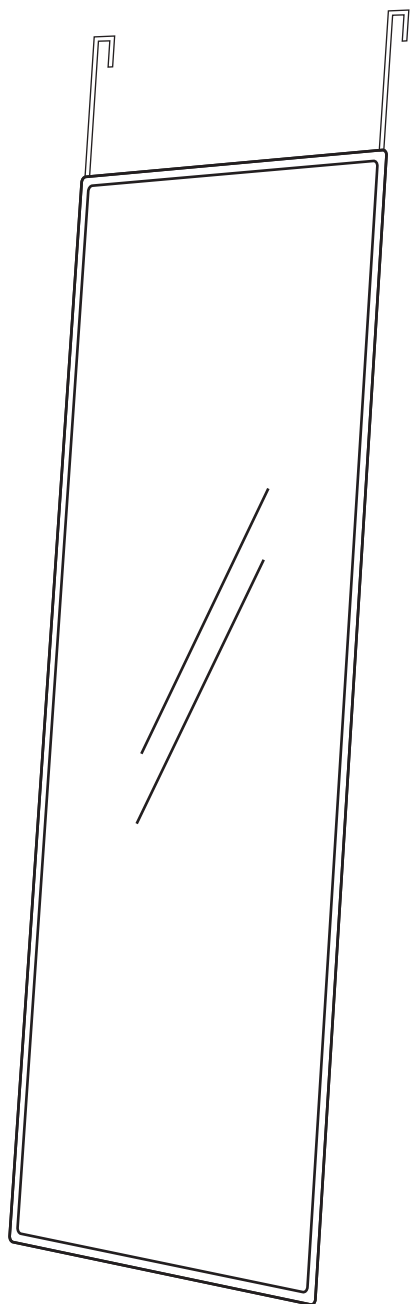

Merci d'avoir choisi ce produit. Nous nous efforçons de vous offrir des produits et des services de la meilleure qualité dans l'industrie. Si vous rencontrez des problèmes, n'hésitez pas à nous contacter.