

Instructions

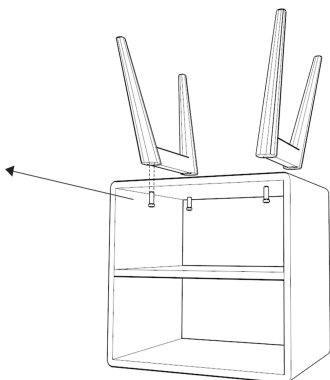
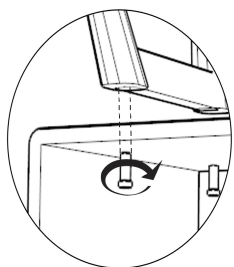

Assembly Instructions:

- 1) Please take out the legs from the drawers, and put in position like diagram
- 2) Using the screws and hex wrench included, please attach legs to the base.
- 3) After legs are installed, please set in drawers like diagram. Assembly is now completed.

Parts Included:

- 1) :Allen Key×1
- 2) :Screws×4

