















# IMPORTANT: READ CAREFULLY AND RETAIN FOR FUTURE REFERENCE

Item number: GF08177

CAUTION: Please unpack all parts on a flat non-abrasive surface and check contents against the parts list. Assembly by two people is advised.

A		1
B		1
C		1
D		1
E		1
F		1
G		1
H		12
I		4
J		8
K		12
L		2
M		2
N		2
O		1

Step 1.

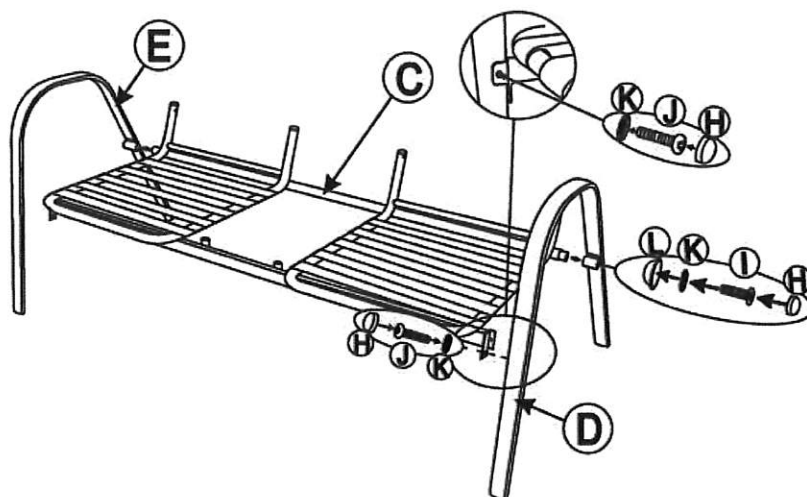

Step 2.

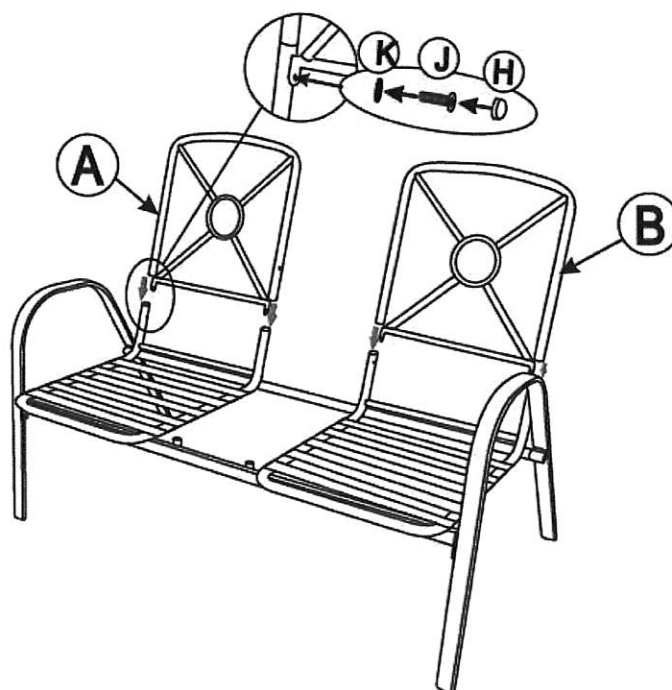

### Step 3.

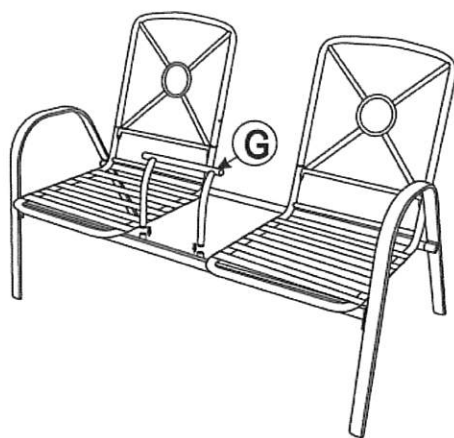

### Step 4.

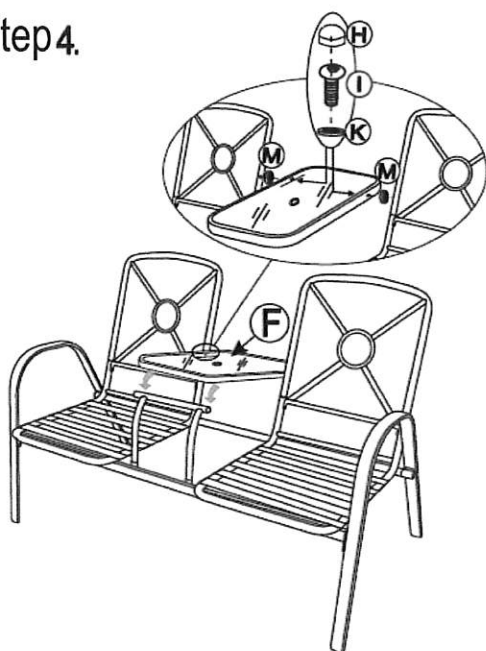

### Step 5.

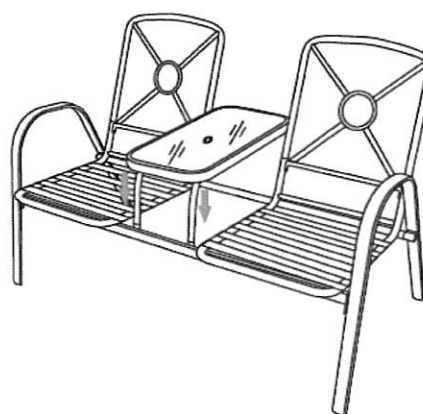

### Step 6.

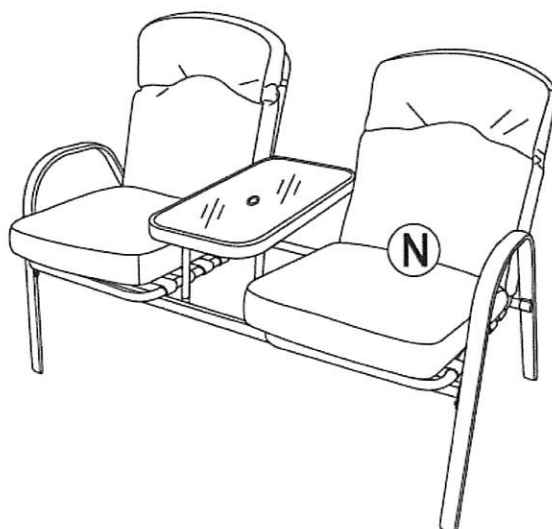

This product is not a toy!

Do NOT fully tighten bolts before all components are connected. Only fully tighten until you are satisfied with the alignment of all components.

Do not overtighten bolts.

For Domestic use only.

Imported by Trans-Continental Group Ltd., Transcon House, Amy Johnson Way, Blackpool, Lancashire, FY4 2RP, UK.

Please refer to the Suntime care leaflet enclosed for information regarding the maintenance and use of your product.