

W3887P395450

W3887P471247      32-33.2\*72inch

W3887P395451

W3887P471257      34-35.2\*72inch

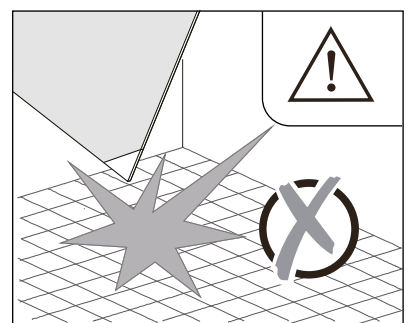
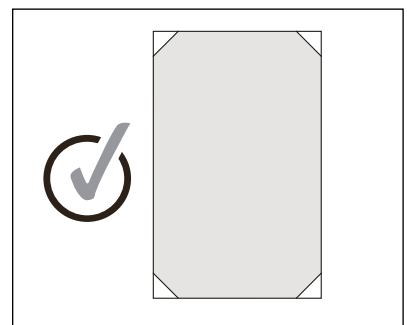
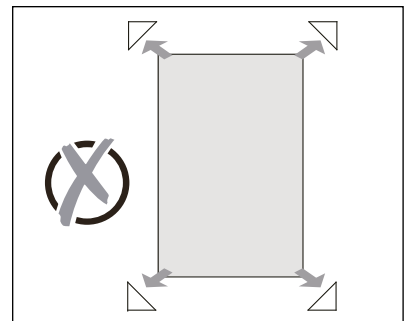
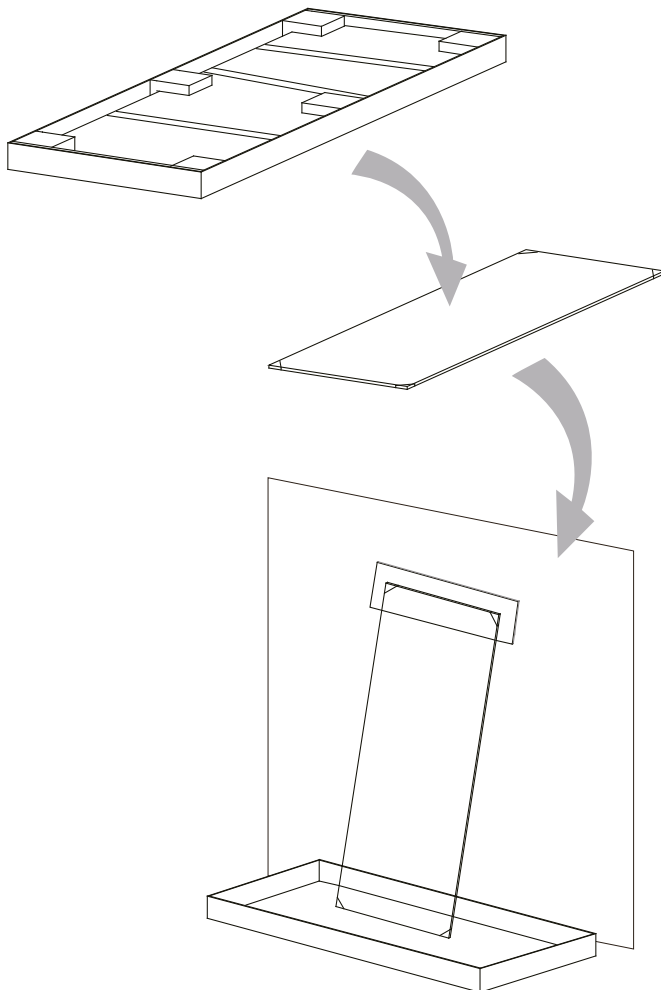
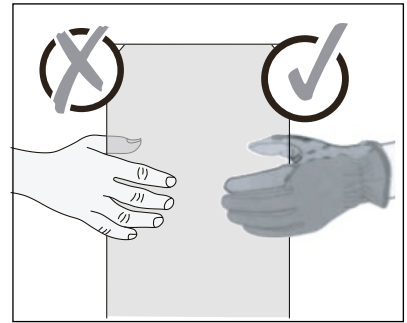
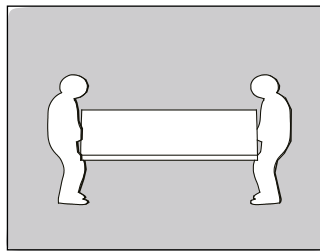
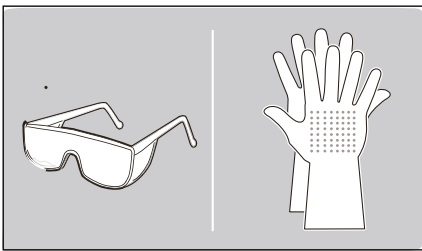
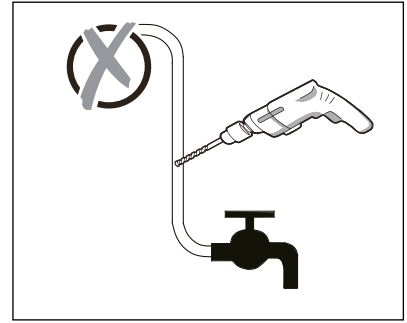
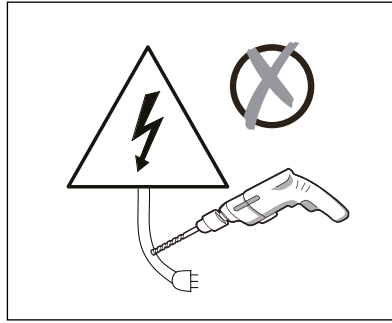
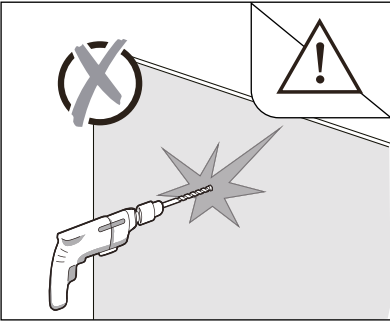

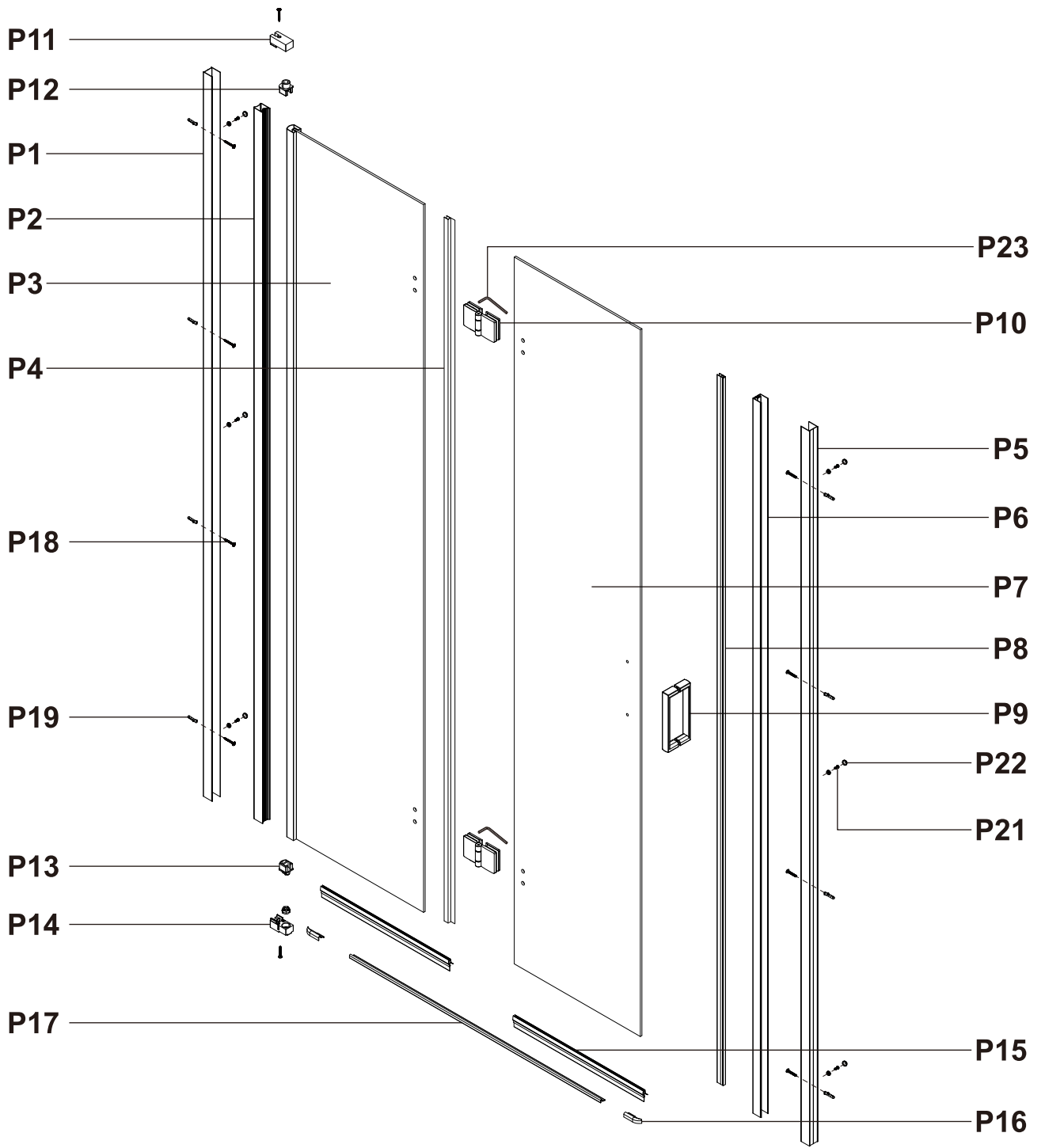

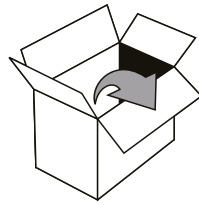

<p><b>P1</b></p> <p>72.05inch</p> <p>X1</p>	<p><b>P2</b></p> <p>X1</p>	<p><b>P3</b></p> <p>X1</p>	<p><b>P4</b></p> <p>X1</p>
<p><b>P5</b></p> <p>71.06inch</p> <p>X1</p>	<p><b>P6</b></p> <p>X1</p>	<p><b>P7</b></p> <p>X1</p>	<p><b>P8</b></p> <p>X1</p>
<p><b>P9</b></p> <p>X1</p>	<p><b>P10</b></p> <p>X2</p>	<p><b>P11</b></p> <p>X1</p>	<p><b>P12</b></p> <p>X1</p>
<p><b>P13</b></p> <p>X1</p>	<p><b>P14</b></p> <p>X1</p>	<p><b>P15</b></p> <p>X2</p>	<p><b>P16</b></p> <p>X1</p>
<p><b>P17</b></p> <p>X1</p>	<p><b>P18</b> ST#8x1.2inch</p> <p>X10</p>	<p><b>P19</b></p> <p>X8</p>	<p><b>P21</b> ST#8x0.4inch</p> <p>X6</p>
<p><b>P22</b></p> <p>X6</p>	<p><b>P23</b></p> <p>X1</p>		

<p>Ø 1/4 inch</p>	
<p>PH2</p>	
<p>Ø 1/8 inch</p>	

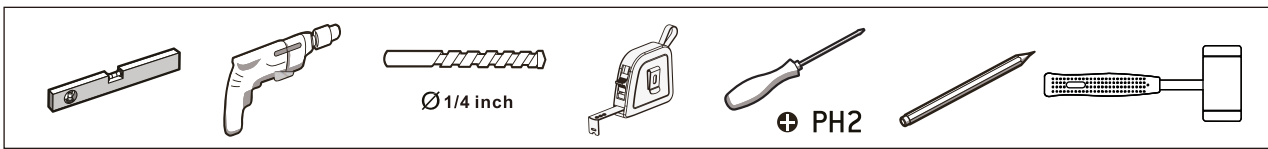

5

**1**

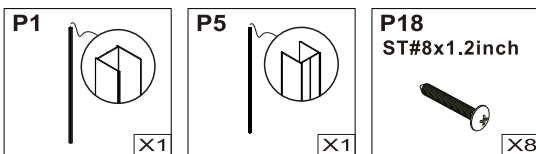
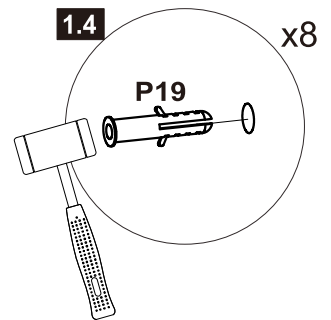
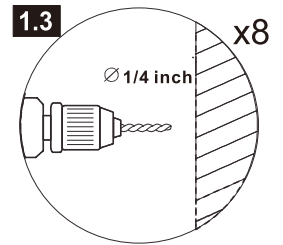
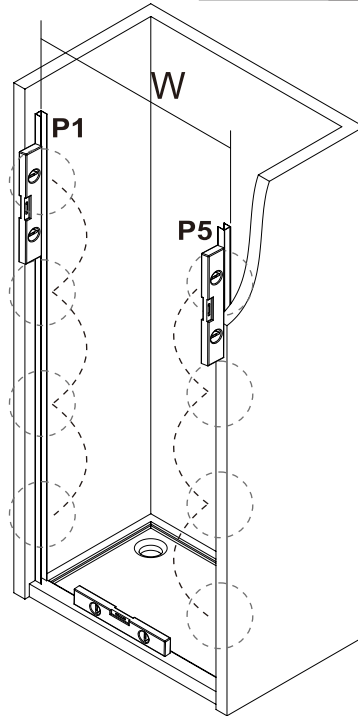
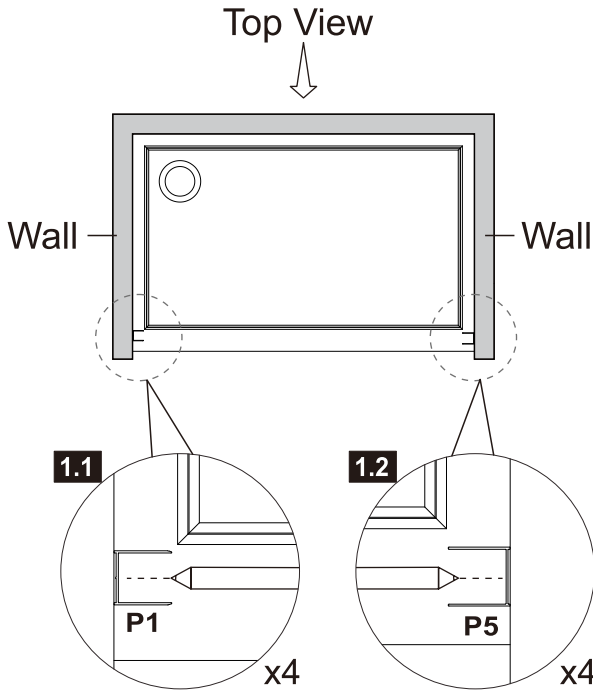
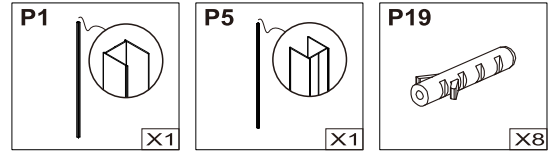

**2**

EN: Position the wall profile against the wall and use a level to ensure it is horizontal. Mark the hole positions, drill holes, insert wall plugs, and tighten the screws.

ES: Coloque el perfil de pared contra la pared y utilice un nivel para asegurarse de que esté horizontal. Marque los orificios, perfora, inserte los tacos de expansión y apriete los tornillos.

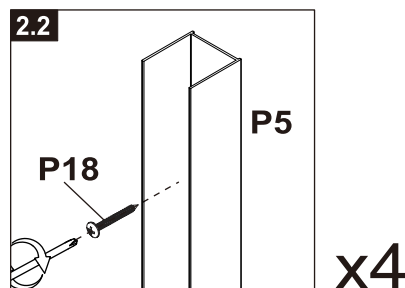
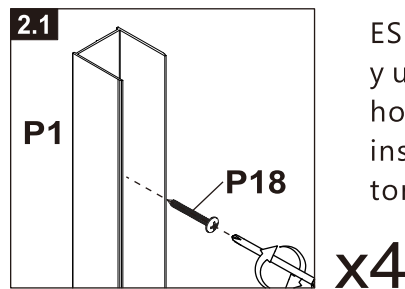
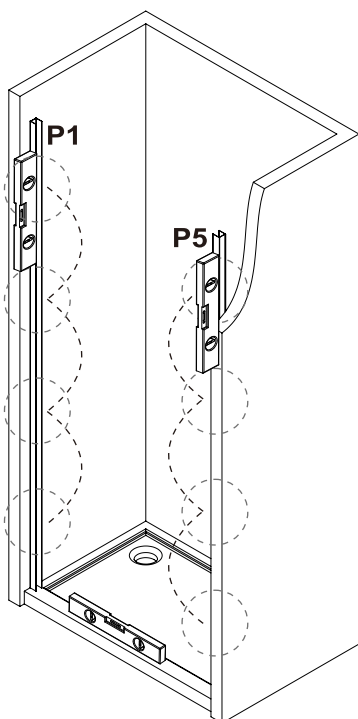

6



PH2

3

3.1

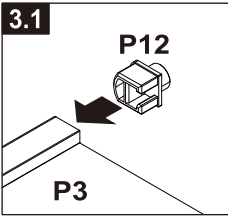

3.2

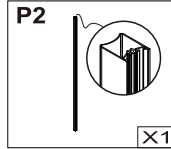
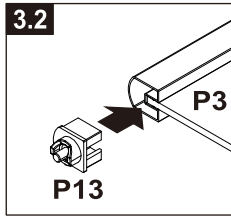

P2

X1

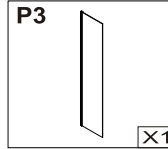

P3

X1

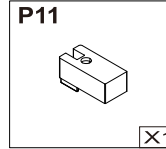

P11

X1

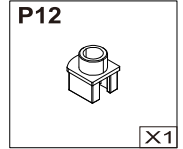

P12

X1

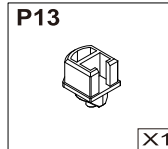

P13

X1

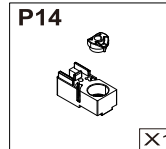

P14

X1

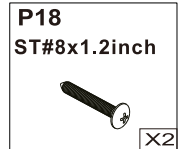
P18  
ST#8x1.2inch

X2

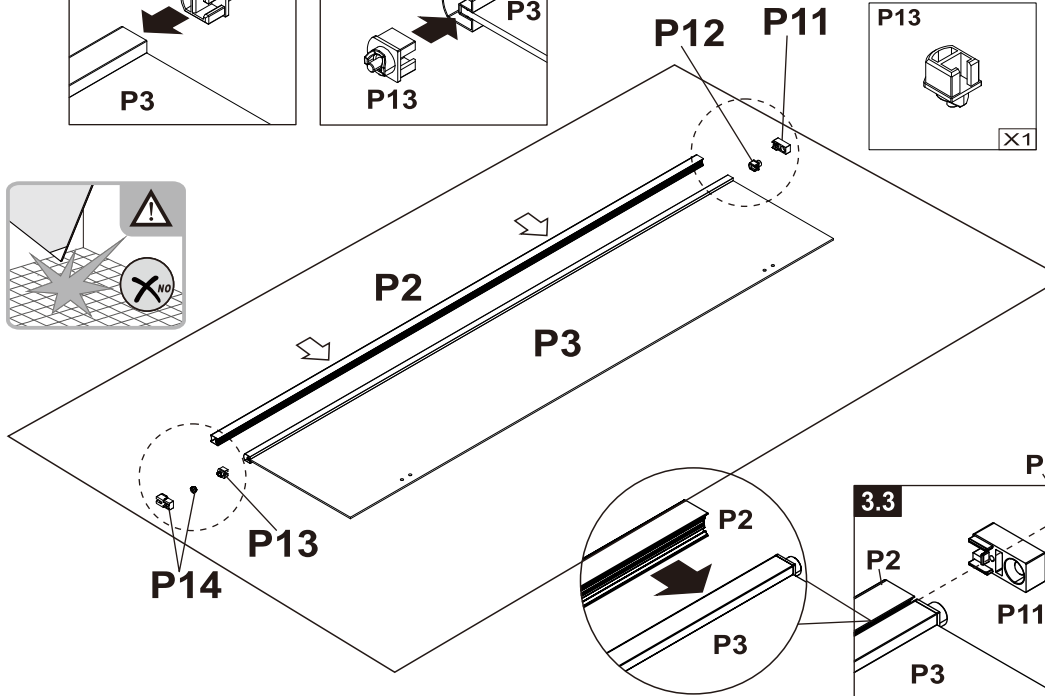
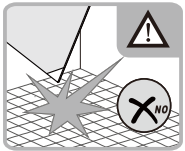

EN : Attach the pivot profile to the glass. Insert the upper and lower pivot pins into the top and bottom, then insert them into the pivot brackets and secure with screws.

ES: Coloque el perfil de pivote en el vidrio. Inserte los ejes de pivote superior e inferior, luego colóquelos en los soportes de pivote y fíjelos con tornillos.

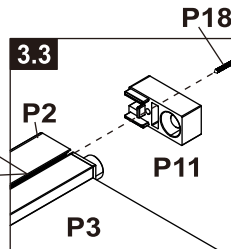

3.3

P18

P2

P3

P3

P11

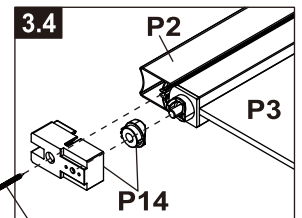

3.4

P2

P3

P3

P14

P18

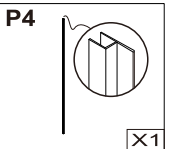

P4

X1

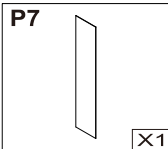

P7

X1

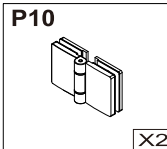

P10

X2

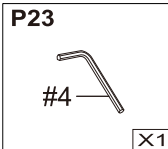

P23

#4

X1

4

EN: Press the water barrier strip onto the edge of the glass. Use a wrench to separate the hinges, then fix the hinges between the two glass panels and tighten with the wrench.

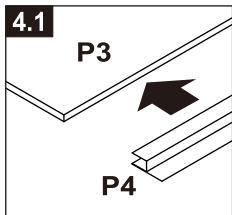

4.1

P3

P4

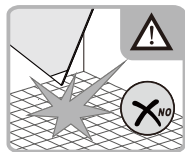

ES: Presione la tira de barrera de agua en el borde del vidrio. Separe las bisagras con una llave, luego fíjelas entre los dos paneles de vidrio y apriete con la llave.

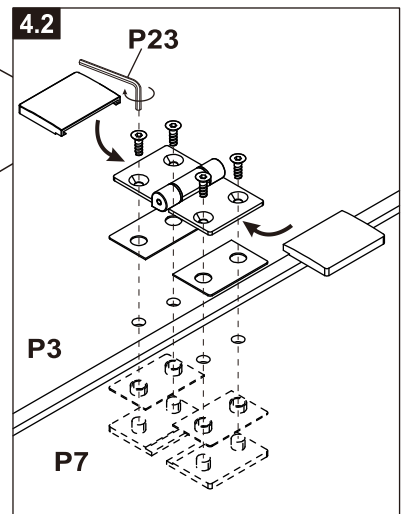
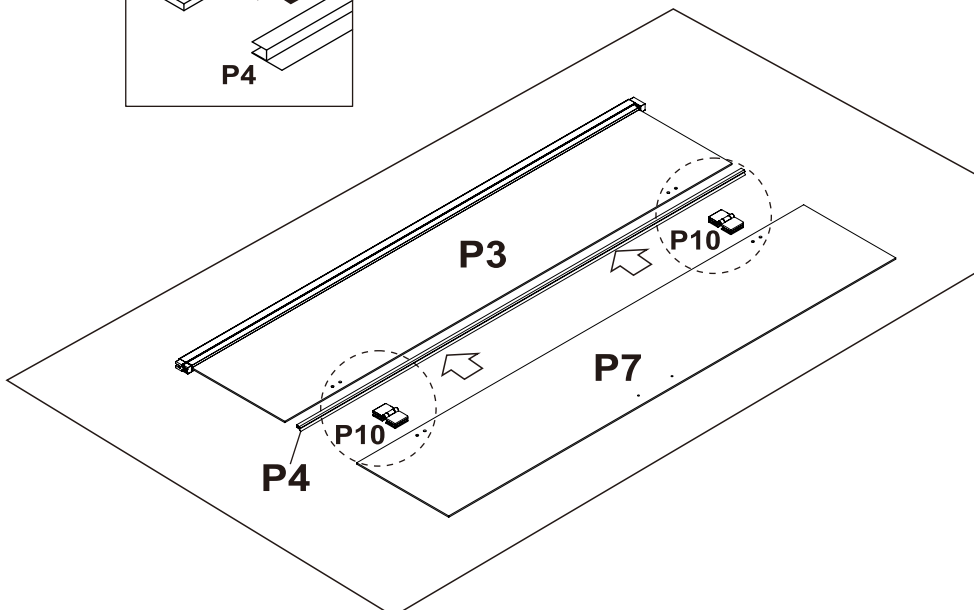

4.2

P23

P3

P7



## 5

EN: Press the magnetic strip onto the side edge of the door glass panel, then press the two bottom water barrier strips onto the bottom edges of the two glass panels.

ES: Presione la tira magnética en el borde lateral del vidrio de la puerta, luego presione las dos tiras inferiores impermeables en los bordes inferiores de los dos paneles de vidrio.

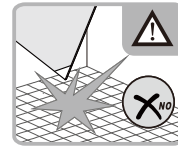
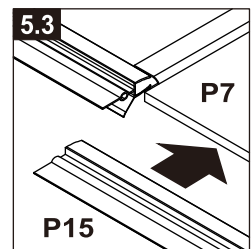
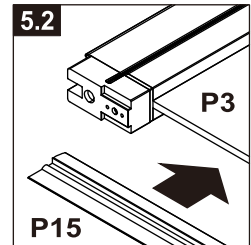
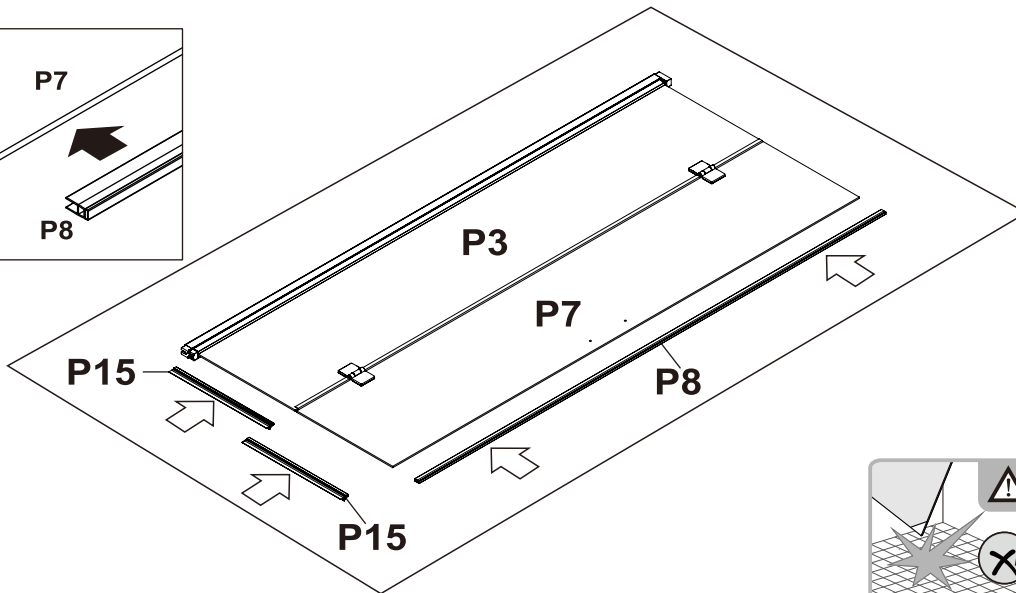
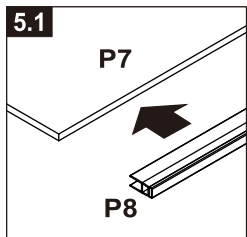
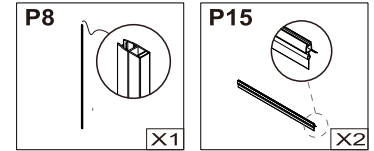

## 6

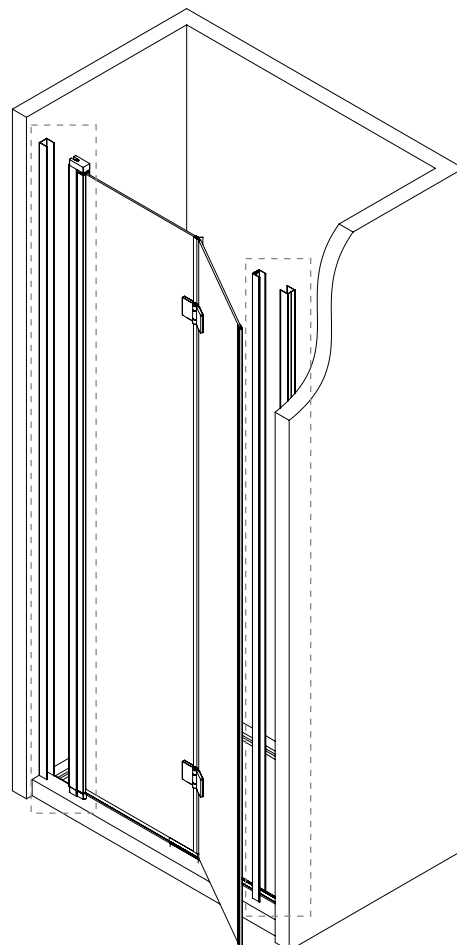
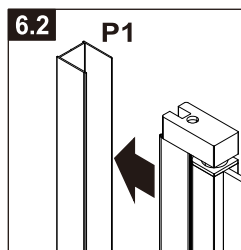
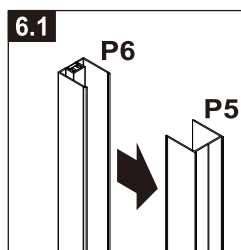
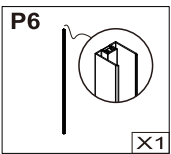

EN: Align the magnetic profile with the groove of the wall profile, then press it in slowly from top to bottom until fully engaged

ES: Alinee el perfil magnético con la ranura del perfil de pared y presiónelo lentamente de arriba hacia abajo hasta que quede encajado.

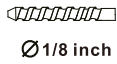

Ø1/8 inch



⊕ PH2

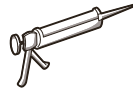

## 7

EN: Use screws to secure the assembled door glass panel to the pivot profile, then install the screw caps

ES: Utilice tornillos para fijar el vidrio de la puerta ensamblado al perfil de pivote y coloque las tapas de los tornillos.

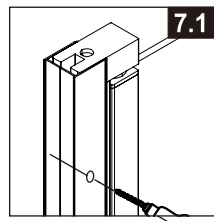

7.1

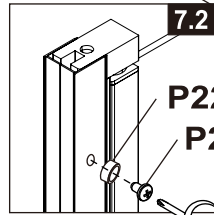

7.2

P22  
P21

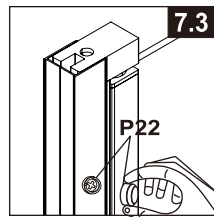

7.3

P22

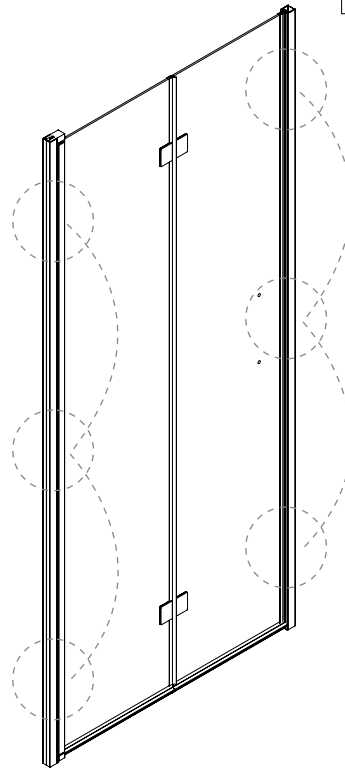

P21  
ST#8x0.4inch



X6

P22



X6

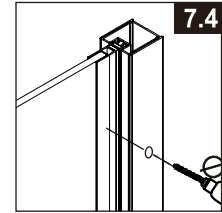

7.4

1/8 inch

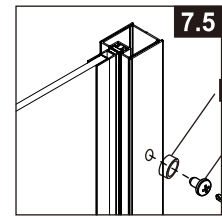

7.5

P22  
P21

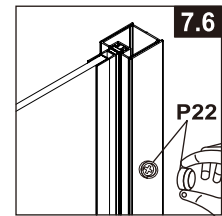

7.6

P22

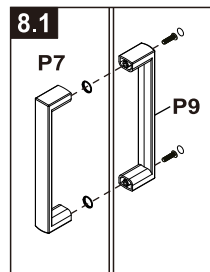
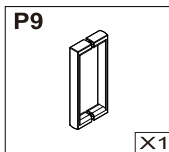
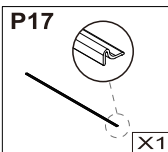
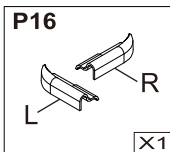

8.1

P7

P9

## 8

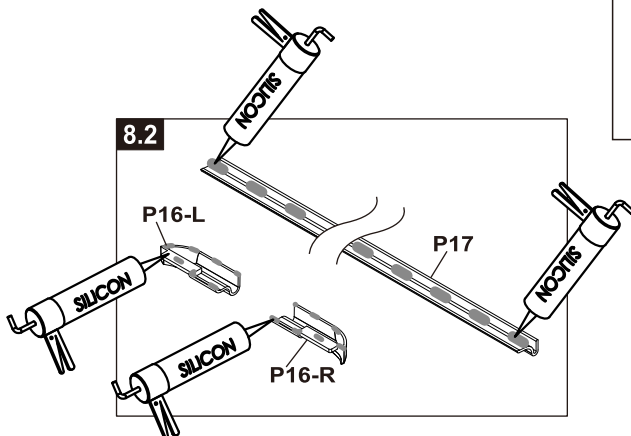

8.2

P16-L

P17

P16-R

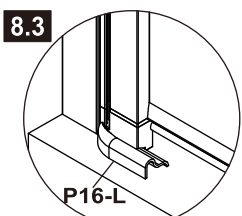

8.3

P16-L

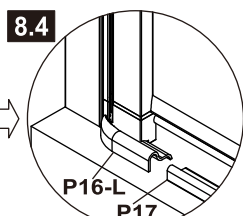

8.4

P16-L

P17

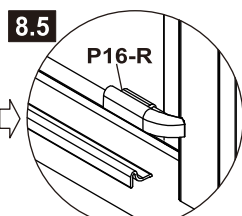

8.5

P16-R

EN: Install the handle onto the door glass panel. Then apply silicone sealant to the bottom of the lower water barrier strip and plastic piece, then fix them onto the floor.

ES: Aplique silicona en la parte inferior de la tira inferior de barrera de agua y de la pieza plástica, luego fíjelas al suelo.

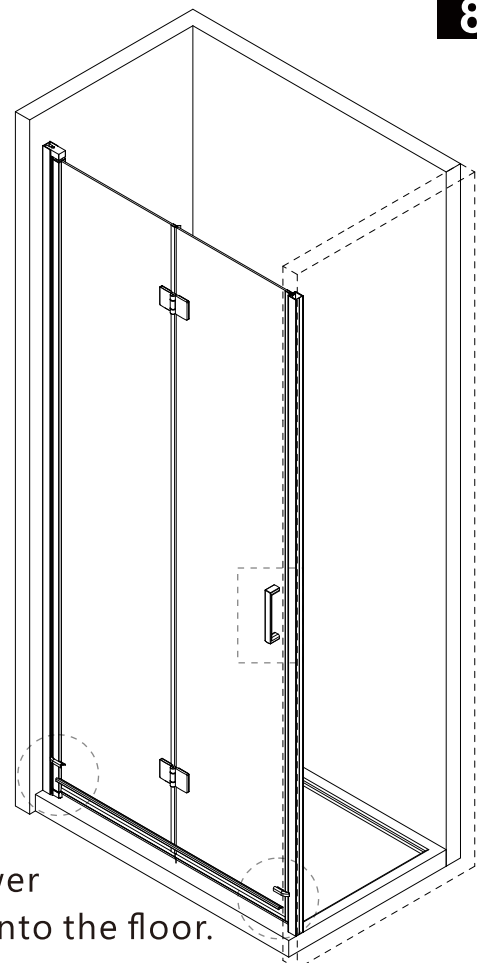

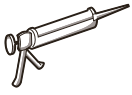
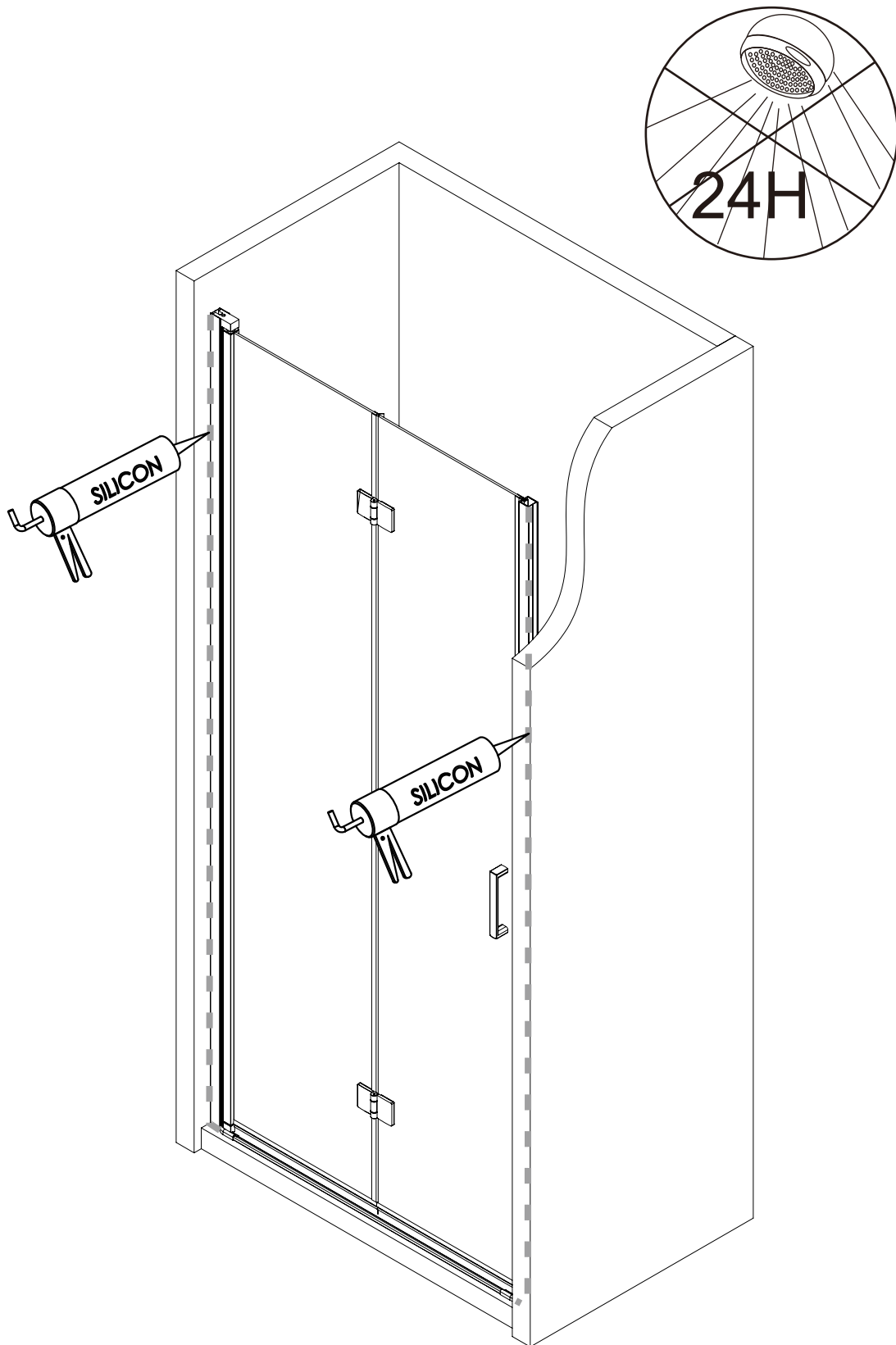
**9**

EN:Apply silicone sealant and allow it to cure for 24 hours before use.

ES:Después de aplicar la silicona, deje secar durante 24 horas antes de usar.