

INSTRUCTION MANUAL

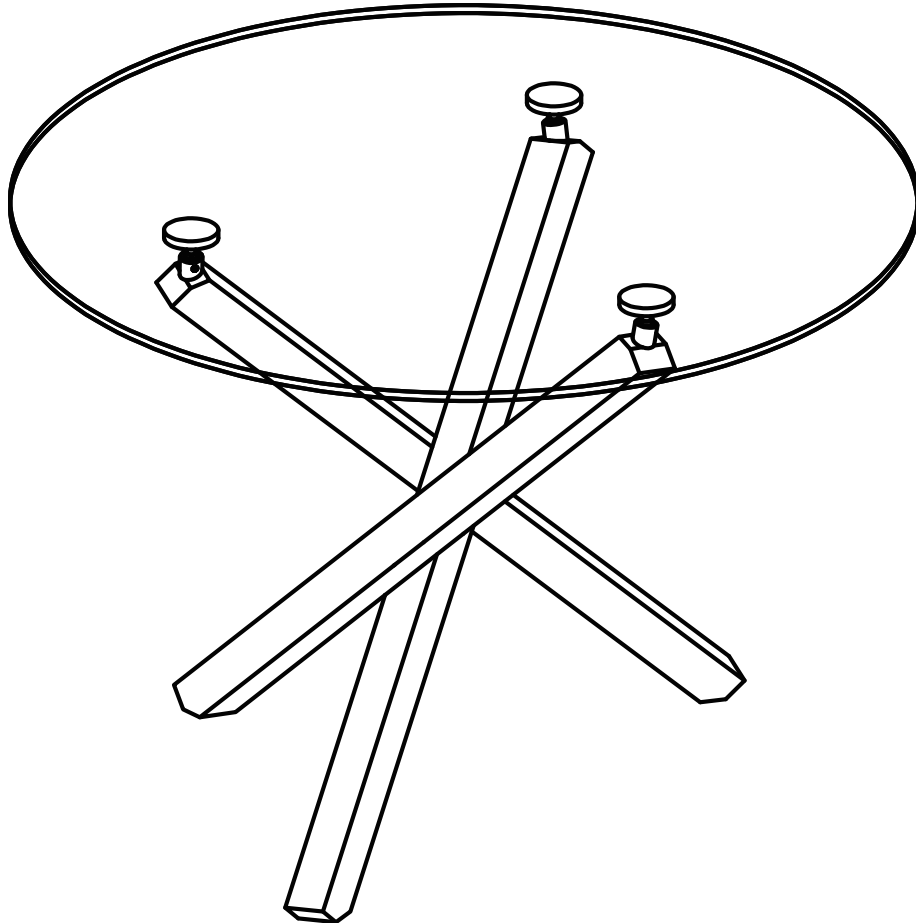

Attention :

If you encounter any problems during installation or use, pls feel free to contact us on shopping platform. We will provide you with a satisfactory solution within 24 hours.

Dining Table

 1 - ITEMS DELIVERED-TECHNICAL DATA

 2-4 - ASSEMBLY

 4 - CLEANING AND MAINTENANCE

 1 - ITEMS DELIVERED-TECHNICAL DATA

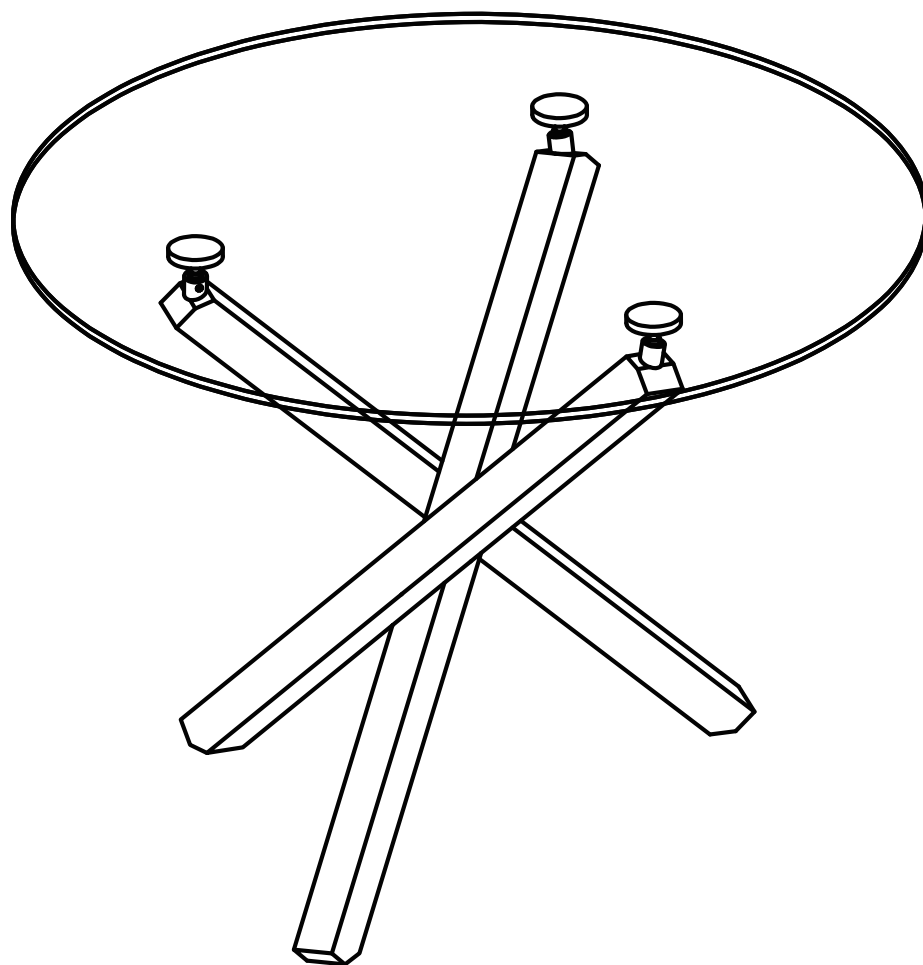

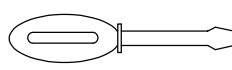

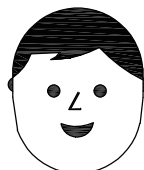

TO RISE

YOURSELF

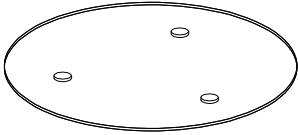
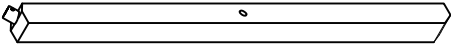
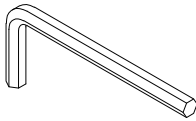
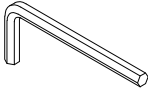
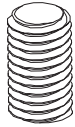
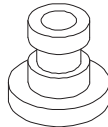
ASSEMBLY

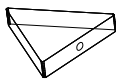

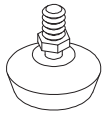
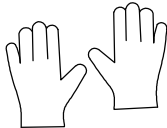
2 - ASSEMBLY

 (A)*1	 (B)*3
 (C)*1	5#  (D)*1 3#
 (E)*3	M8*20  (F)*3 23*23
 (G)*3	M6*10  (H)*1 62.5*62.5*15
 (I)*3	M8*50  (J)*3 M8*32
 (K)*1	



(E) *3

M8*20

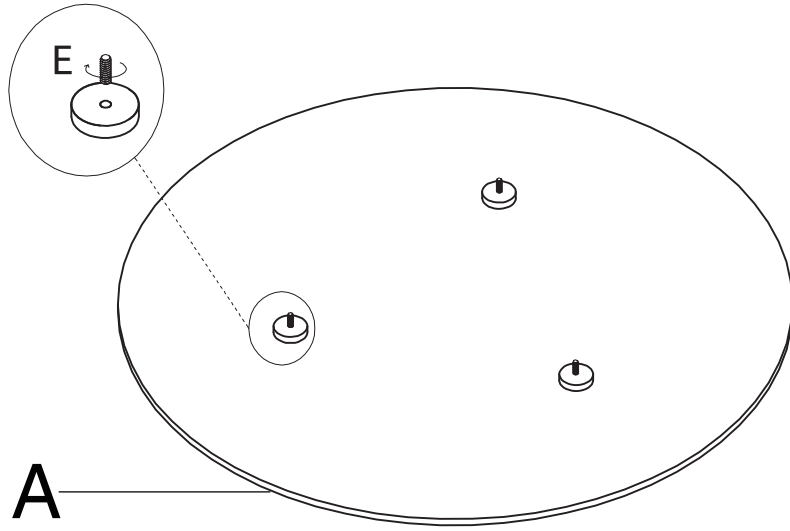

1

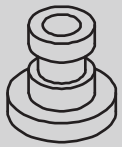

(F) *3

23*23

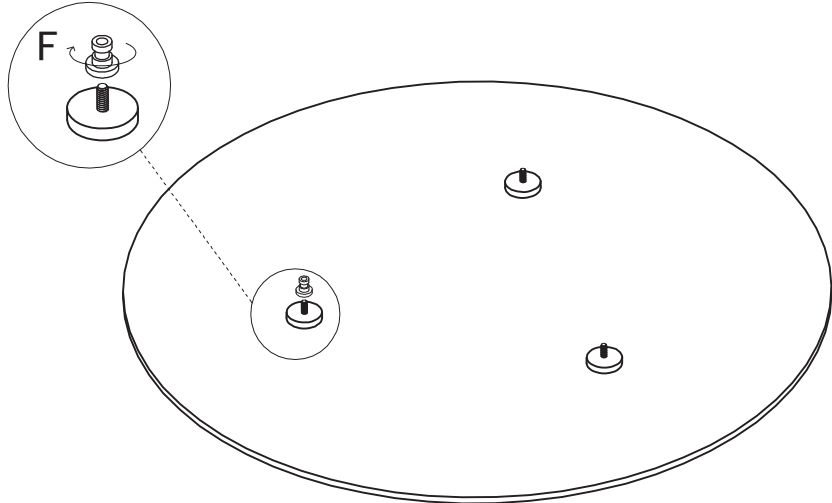

2



(C) *1

5#

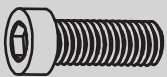

(I) *3

M8*50

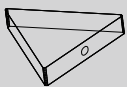

(H) *1

62.5*62.5*15

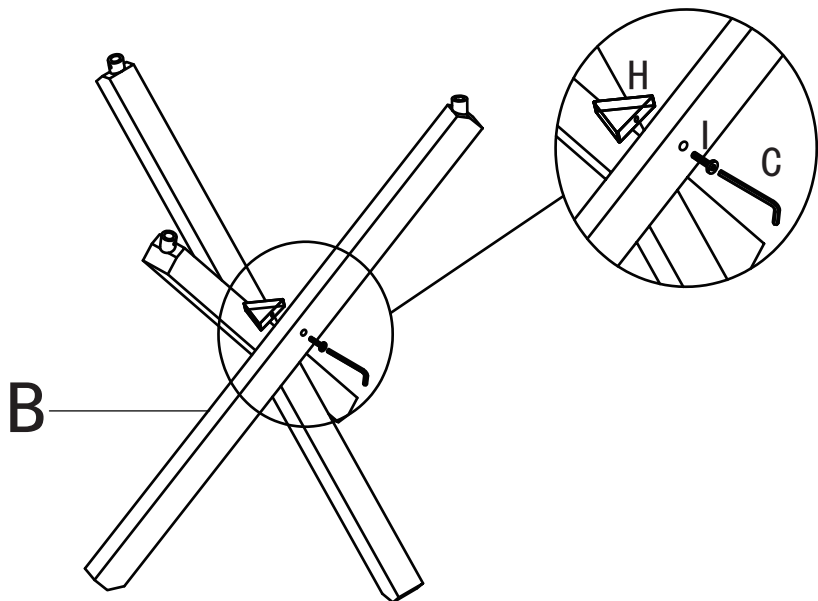

3

3

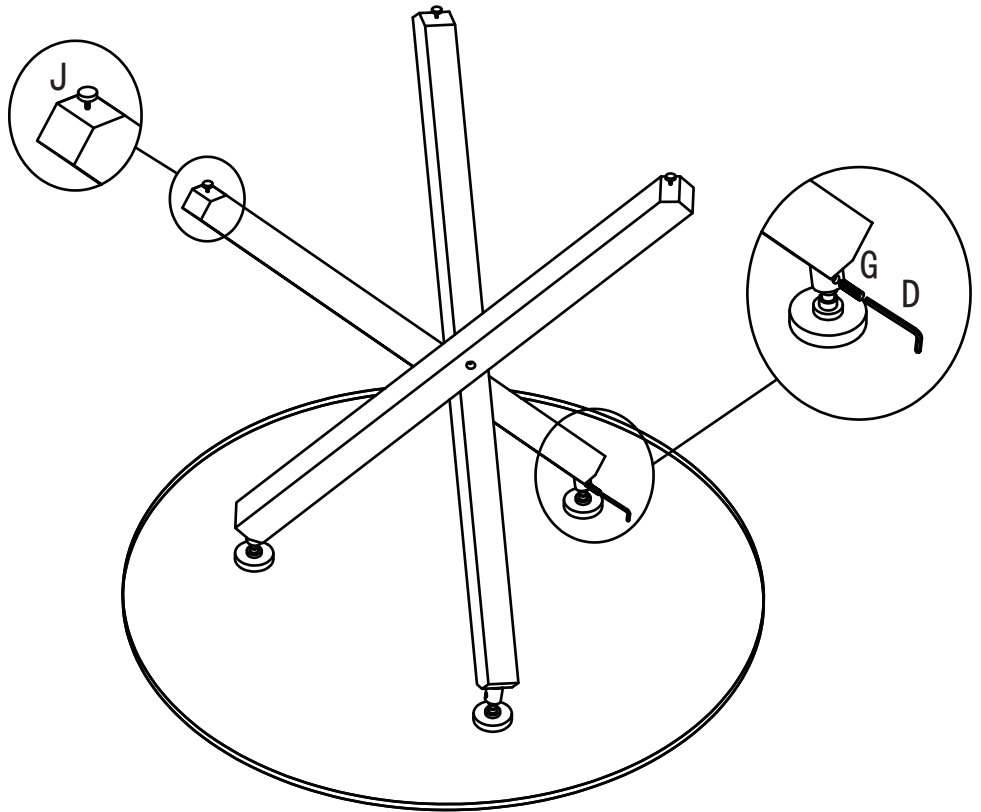
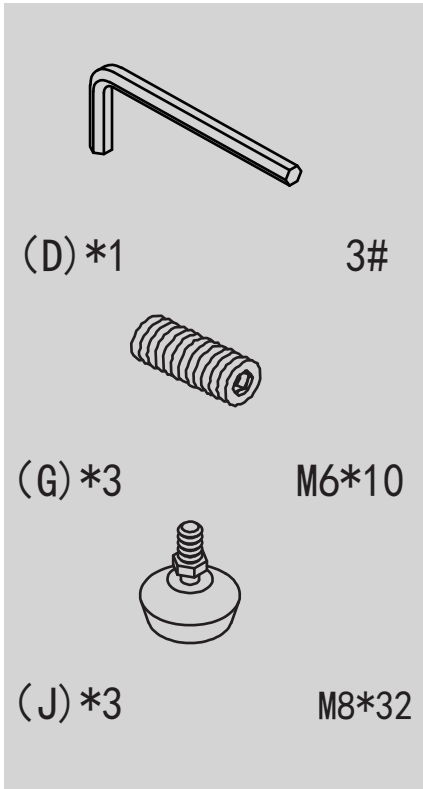

3 - CLEANING AND MAINTENANCE

- Do not use corrosive or abrasive for cleaning products.
- Clean with a soft cloth
- Don't interfere with metal objects in a mechanism, so that they are threatened with serious deterioration.