

Owner Manual

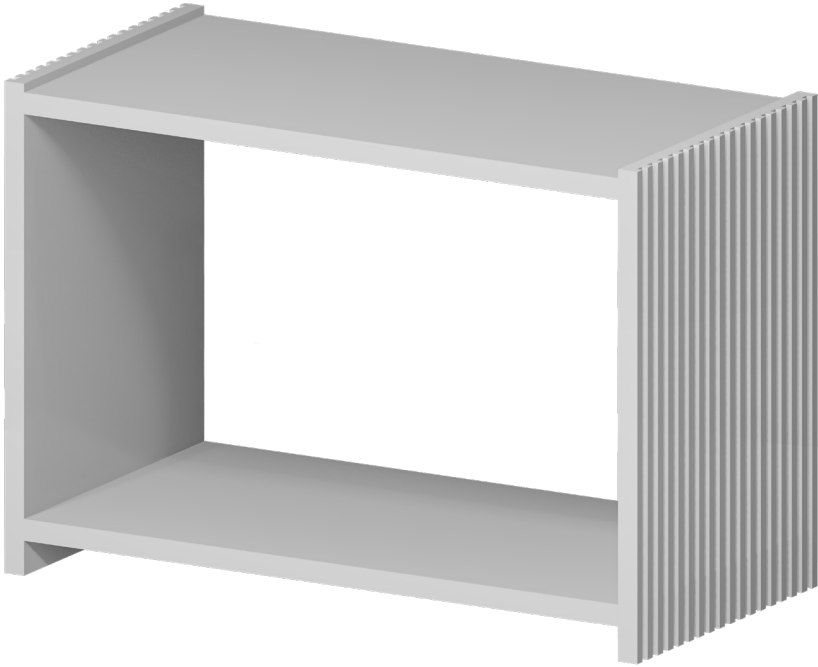

10 : 00

estimated assembly



2 or more

people required

Ok, let's
get started!



- Put on mood music!
- To prevent damage to product, use the clean side of package carton or rug as working surface.
- In the event of missing or damaged parts, delivery problems etc., please reach out to our team. We will be happy to fix the problem!

care guide

- Clean regularly with a soft and dry cloth.
- To protect finish, avoid use of abrasive cleaners.
- Wipe up spills immediately. Please!



product parts

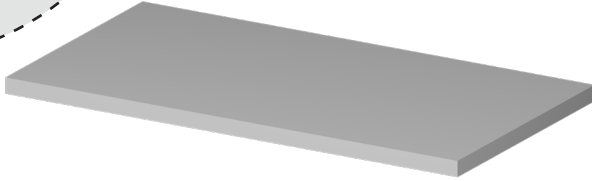

(A)
Top shelf
x1

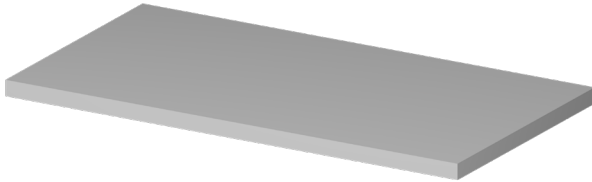

(B)
Bottom Shelf
x1

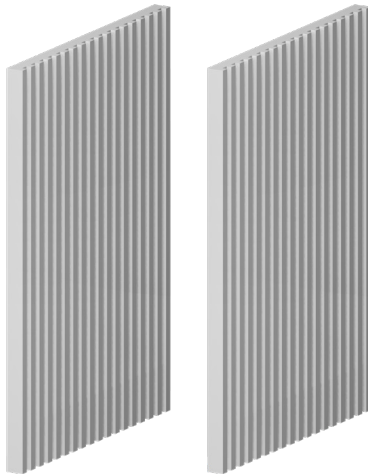

(C)
Table legs
x2

what's included



(D)- Bolt
(8 x 40mm)
x8



(E)- Plain Washer
x8



(F)- Lock Washer
x8

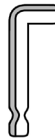

(G)- Allen Key
(5mm)
x1

GS

Green Sticker

YS

Yellow Sticker

assembly instructions

Friendly Tip: Take a deep breath going in. This may be a tricky part, but nothing too overwhelming. Just follow these steps to the T and the outcome will be worth it!



- ⓘ While assembling the product, tighten the bolts up to 50%. Once all parts are in place, only then fully tighten the bolts.

step 1:

Start by placing the top shelf (A) and table legs (C) upside down on the ground. Now, align (A) with the legs (B) in such a way that the yellow (YS) and green (GS) stickers align with their respective others.

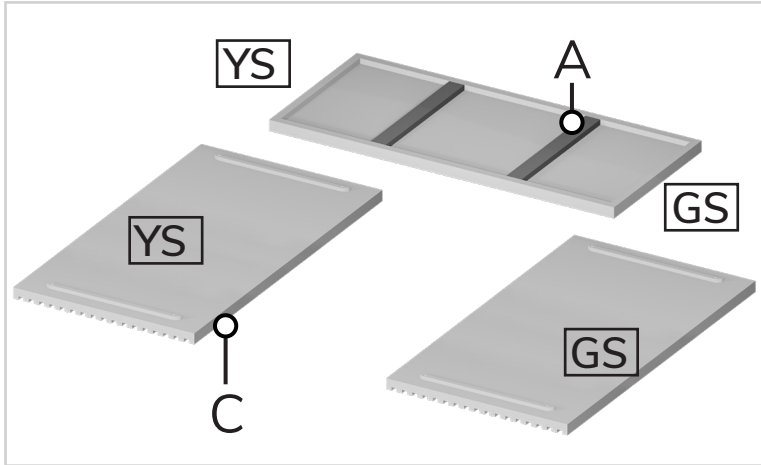

step 2:

Now, attach both legs (C) with the top shelf (A) by inserting washer (E), lock washer (F), and bolts (D) in the given slots. Tighten all the bolts upto 50% using allen key (G). Use the image below as reference.

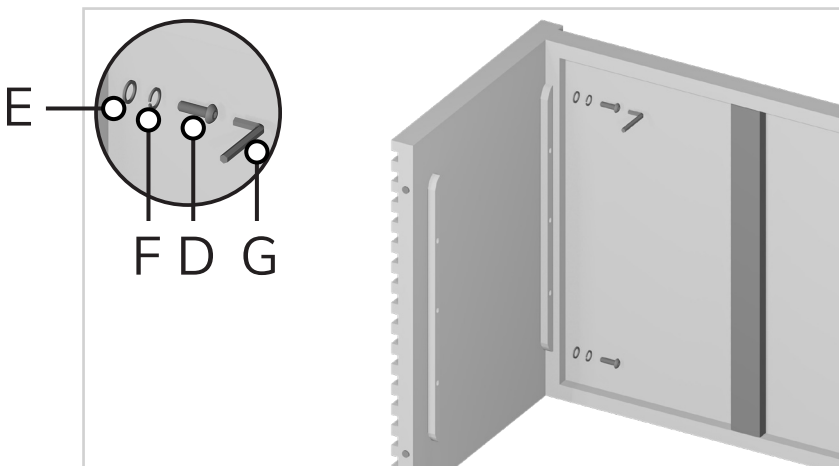

step 3:

Similarly, align and place the bottom shelf (B) over the slots at the bottom of the legs (C).

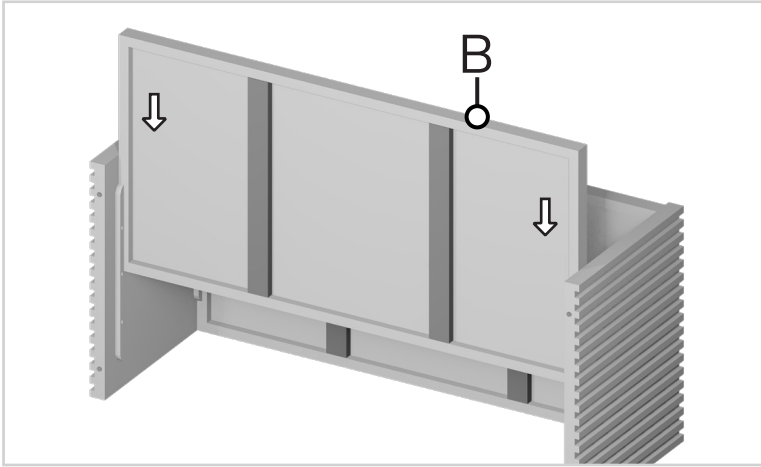

step 4:

Fix them together by inserting washer (E), lock washer (F), and bolts (D) in the given slots. Then, tighten all the bolts fully using allen key (G).

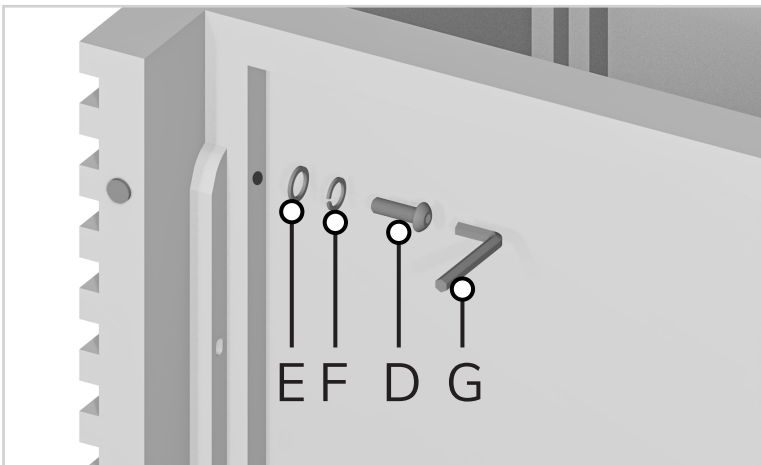

step 5:

If required, adjust the levellers according to the floor as shown in the image.

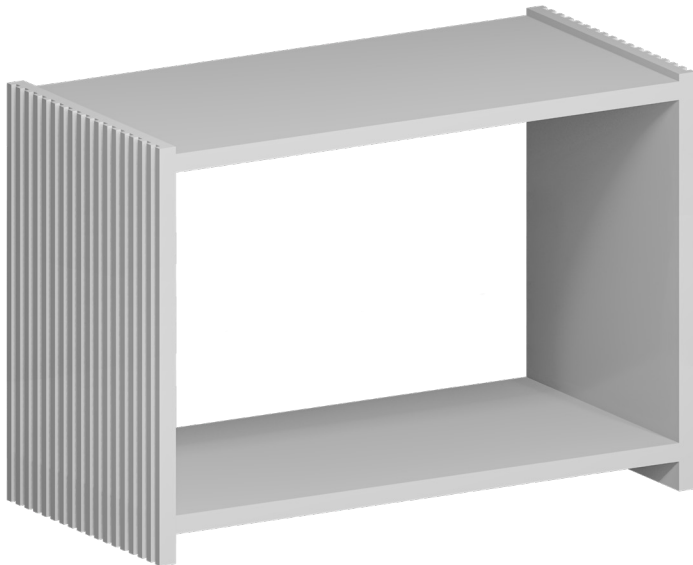
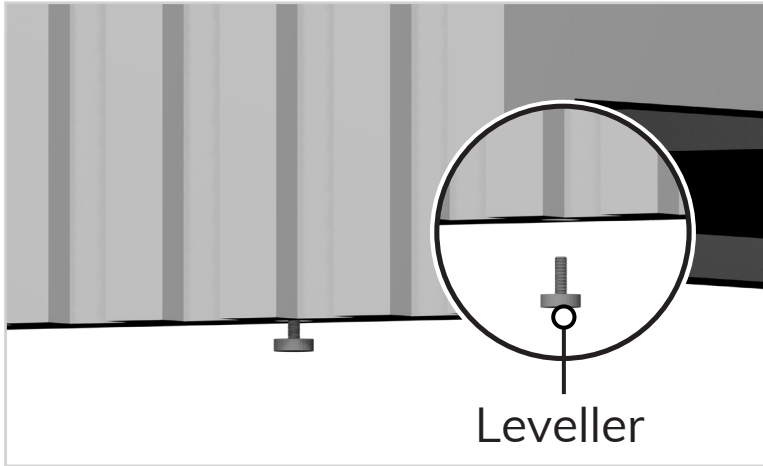

Voila! Your console table is now assembled and secure!