

ASSEMBLY INSTRUCTIONS



Fine Furniture for every stage of life

ASSEMBLY INSTRUCTIONS

ASSEMBLY TIPS:

1. Remove hardware from box and sort by size.
2. Please check to see that all hardware and parts are present prior to start of assembly.
3. Please follow attached instruction in the same sequence as numbered to assure fast & easy assembly.



WARNING!

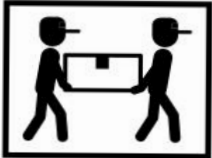

1. Don't attempt to repair or modify parts that are broken or defective. Please contact the store
2. This product is for home use only and not intended for commercial establishment.







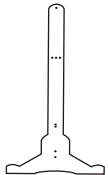

ASSEMBLY TIME	15 MINUTES
---------------	------------

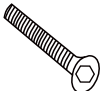
PARTS IDENTIFICATION:.

Z HARDWARE IDENTIFICATION

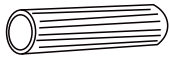
A		Mirror cabinet	1PCS
B		Leg	2PCS
C		Top crossbar	1PCS
D		Bottom crossbar	1PCS

1		Long screws Ø0.5x4.5mm	6PCS
2		Bolts Ø1x1.1mm	6PCS
3		Main connecting screws Ø0.5x6.5mm	2PCS
4		Plastic washer Ø3mm	2PCS
5		Wooden dowel Ø0.8x3mm	4PCS
6		Allen key M6x6.7	1PCS

ASSEMBLY INSTRUCTIONS
STEP 1

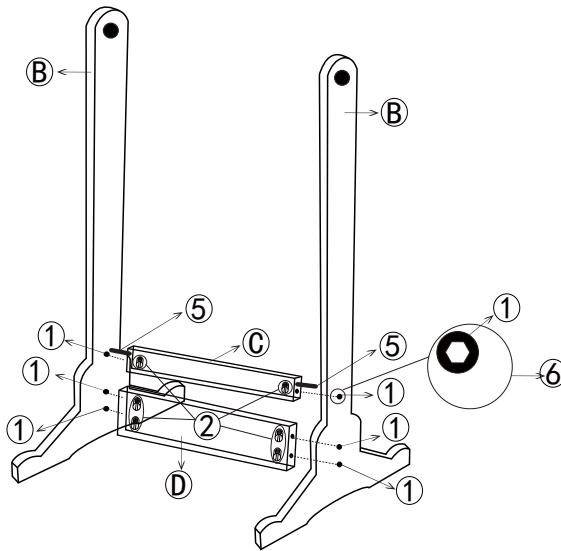

STEP 2

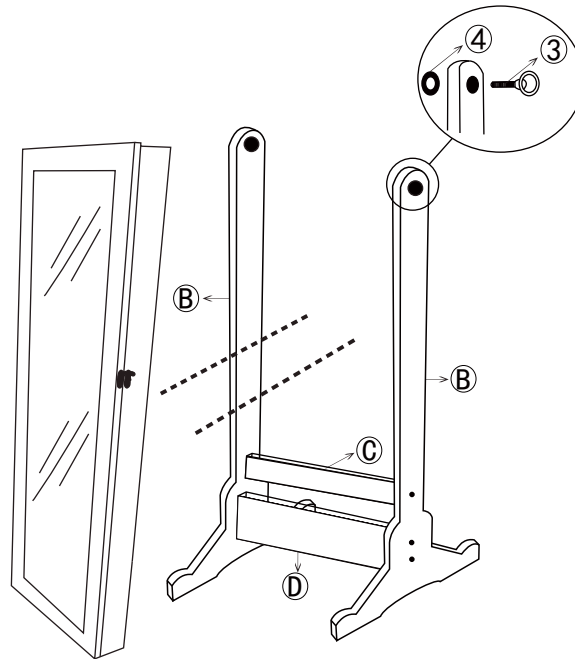

STEP 3

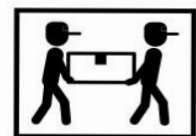
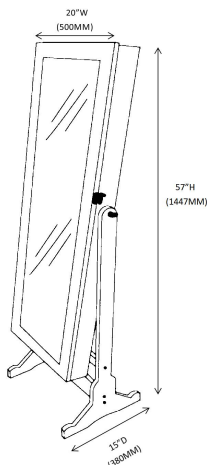

Note: Dimension tolerance $\pm 5\%$