

Power Swivel & Glider Recliner Assembly Manual

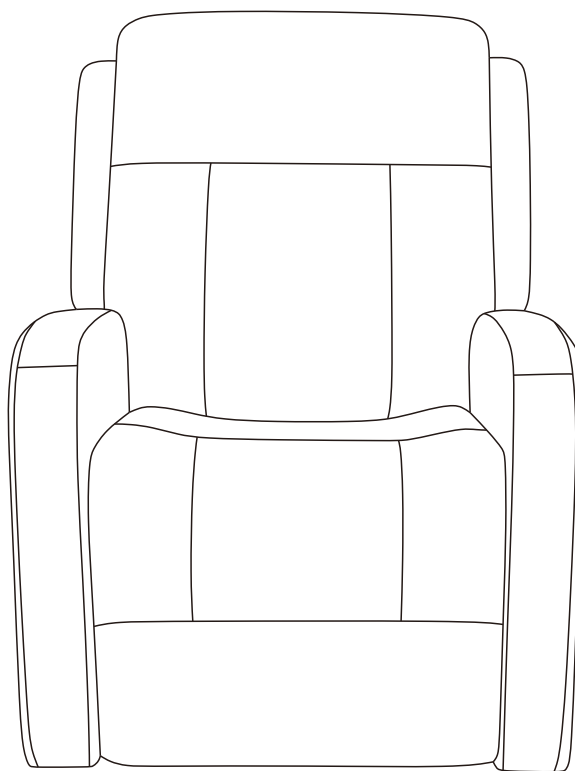
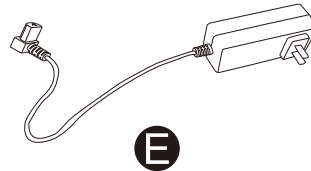
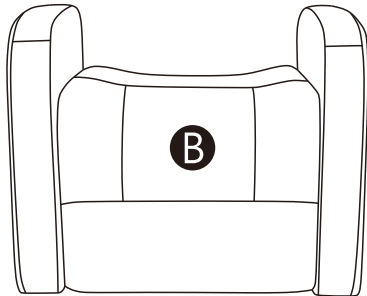
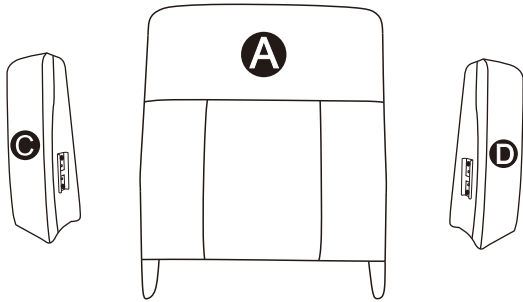

 CAUTION

THIS ASSEMBLY MANUAL CONTAINS IMPORTANT SAFTY INFORMATION.
PLEASE READ AND KEEP FOR FUTURE REDERENCE.

COMPONENTS



- A** Chair Back
1X
- B** Chair Base
1X
- C** Left wing
1X
- D** Right Wing
1X
- E** Power Cable
1X

WARNING

Find a yellow protector at the bottom, then remove it before using.

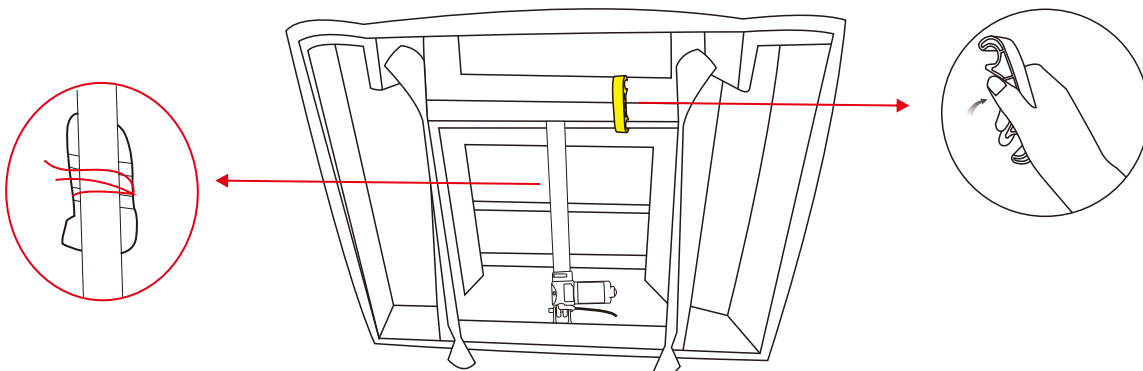

1

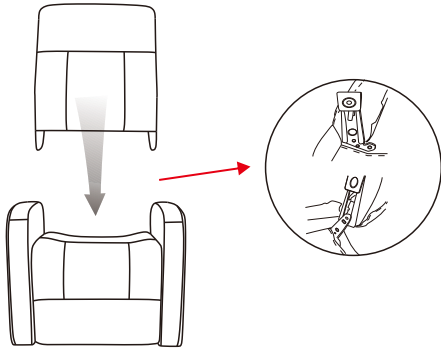

2

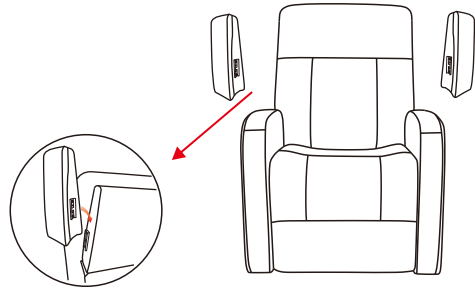

3

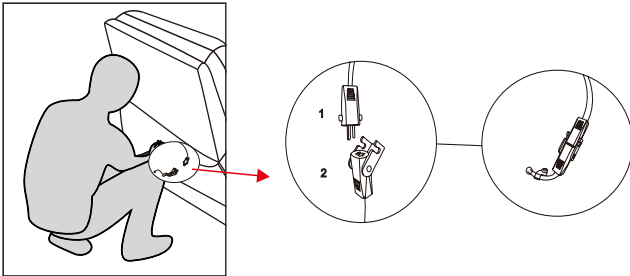

4

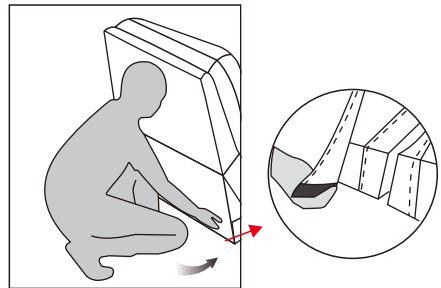

5

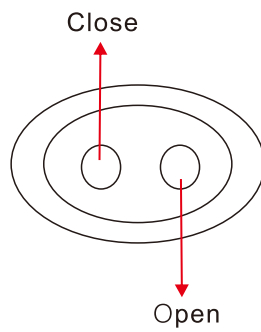
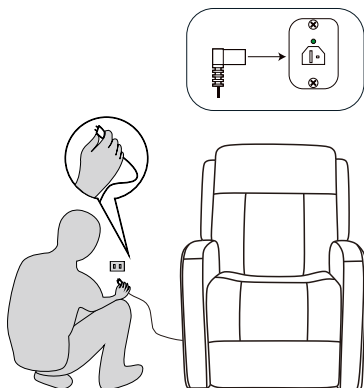

PRODUCT WARRANTY

- 1-year limited on leather against splitting, peeling, and/or tearing.
- 1-year limited on internal and external frame structure.
- 1-year limited on cushioning material, seat springs and mechanism.

CARE & MAINTENANCE

Periodic dusting will prolong the life of your leather.

General cleaning can be done with a damp, clean, soft white cloth.

Periodically, a mild leather cleaner can be used on the headrests and armrests. This will help prevent buildup of body and hair oils which can harm the leather over time.

For more stubborn stains, a mild leather cleaner can be used or consult a professional leather technician.