



USER MANUAL

Safety Information

- Do not completely tighten screws until all screws are started. Tighten each bolt firmly and properly.
- Some parts may contain sharp edges. Wear protective gloves as necessary.
- Children under the age of 16 should not be engaged in the assembly, removal or disassembly of the product. Children under the age of 10 should be supervised by a competent adult while using this furniture.
- Please keep children out of the assembly area during assembly.
- This set is heavy, and may require two adults for safe assembly.
- Never use this product as a support. Do not shake, lean, or climb on the product at any time.



DANGER : Do not allow children to play with plastic wraps or small parts to prevent potential choking hazard.



CAUTION: Read all the instructions before assembly. Failure to do so may result in faulty assembly and potential injury!

Warranty

LIMITED WARRANTY

This warranty is a limited warranty, and applies to the original purchase is required. This is a residential warranty and does not apply to commercial use. This collection carries a (1) year limited warranty and is valid from original date of purchase to the original owner (proof of purchase required).

WHAT IS COVERED

We warrant the frame to be free of Manufacturing defects to the original purchaser for one year.

WHAT IS NOT COVERED

This warranty does not cover commercial use, hardware, acts of nature, fire, freezing and abusive.

In addition, purchased parts are not covered under this warranty.

We reserve the right to make substitutions with similar merchandise, if the model in question is no longer in production.

For a copy of our full limited warranty, please contact our customer service team.



Cleaning and Maintenance

- Clean the furniture with damp cloth, rinse thoroughly. Dry frame parts completely. Do not use bleach, acid or other solvents on the textile or metal parts.
- We recommend the use of furniture covers to protect the product when not in use.
- Inspect and tighten all screws on a regular basis to ensure proper performance and safety.
- In order to prolong the life and beauty of your product, we recommend storing it in a dry and protected area during off season periods.

ANTES DE INICIAR:

1. Revise el manual detenidamente y distinga cada pieza y tornillo.
2. Siga paso a paso el instructivo y asegúrese de hacer buena presión en las piezas para su correcta fijación.

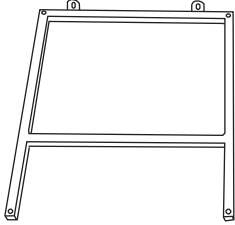
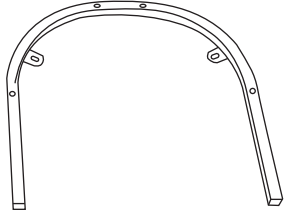
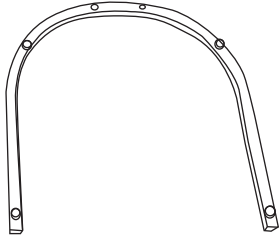
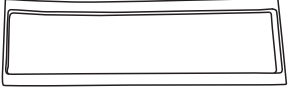
PIEZAS Y TORNILLOS

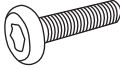
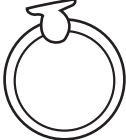
<p>A_x1</p> 	<p>B_x1</p> 	<p>C_x1</p> 
<p>D_x1</p> 	<p>E_x1</p> 	<p>F_x4</p>  <p>M6*20MM</p>
<p>G_x1</p>  <p>M6</p>	<p>H_x8</p>  <p>M8*30MM</p>	<p>I_x1</p> 

1

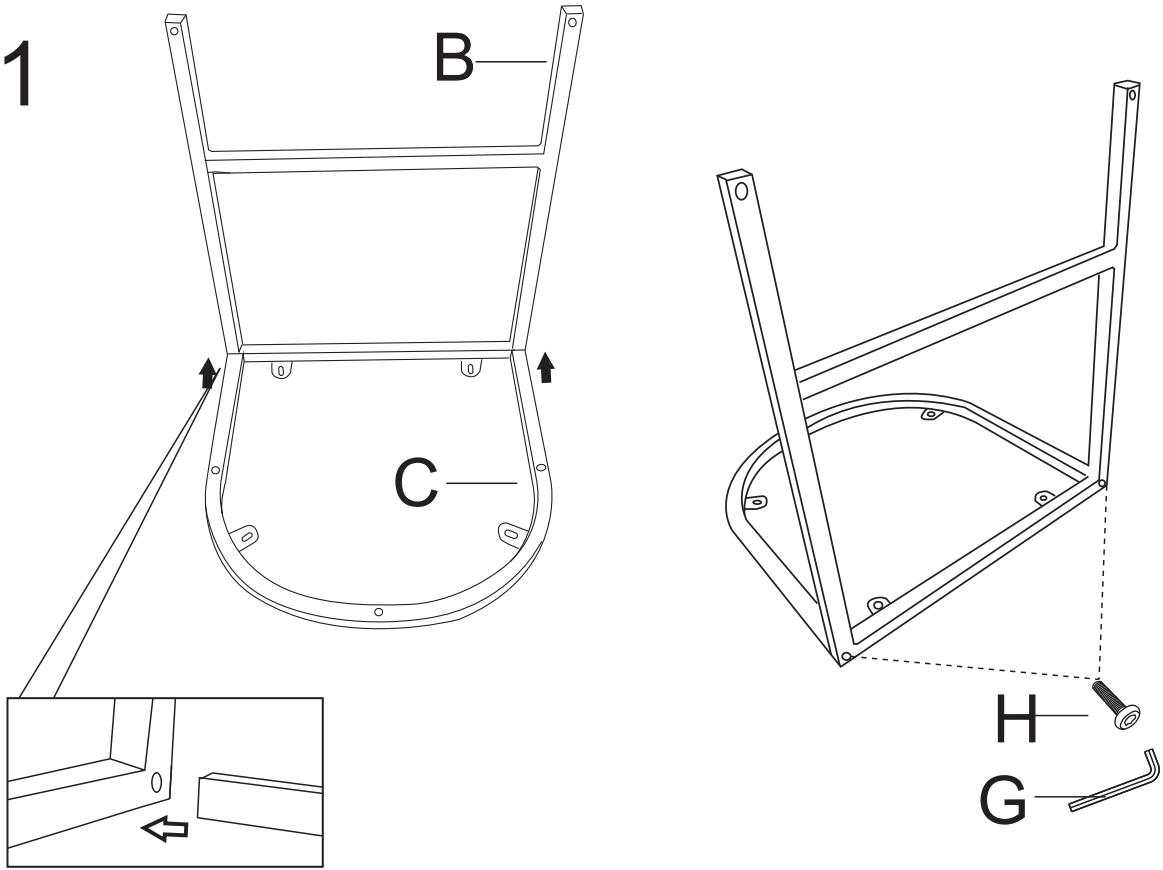

2

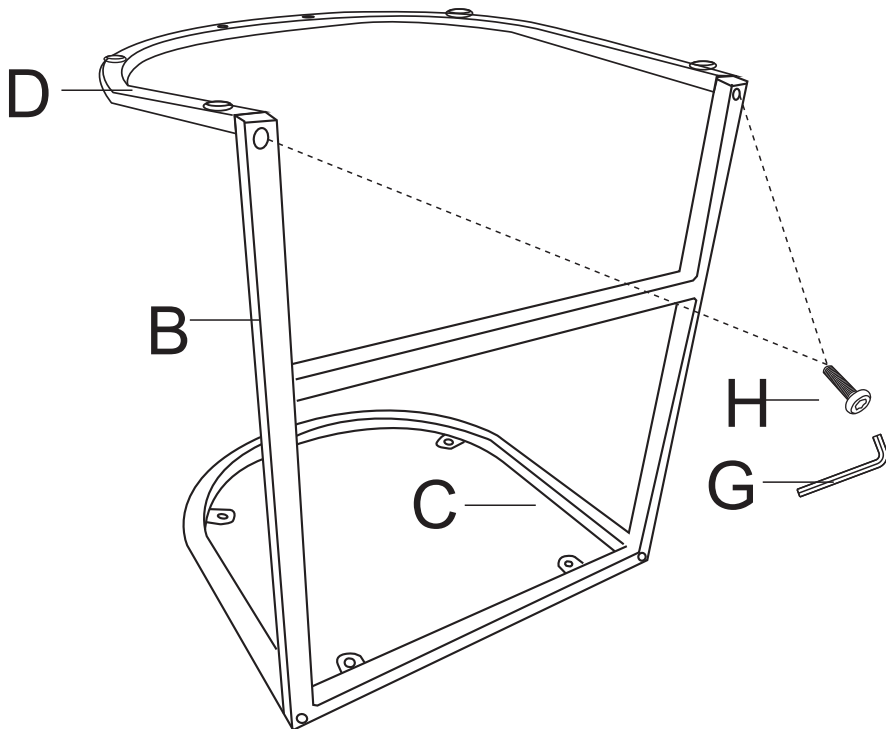

3

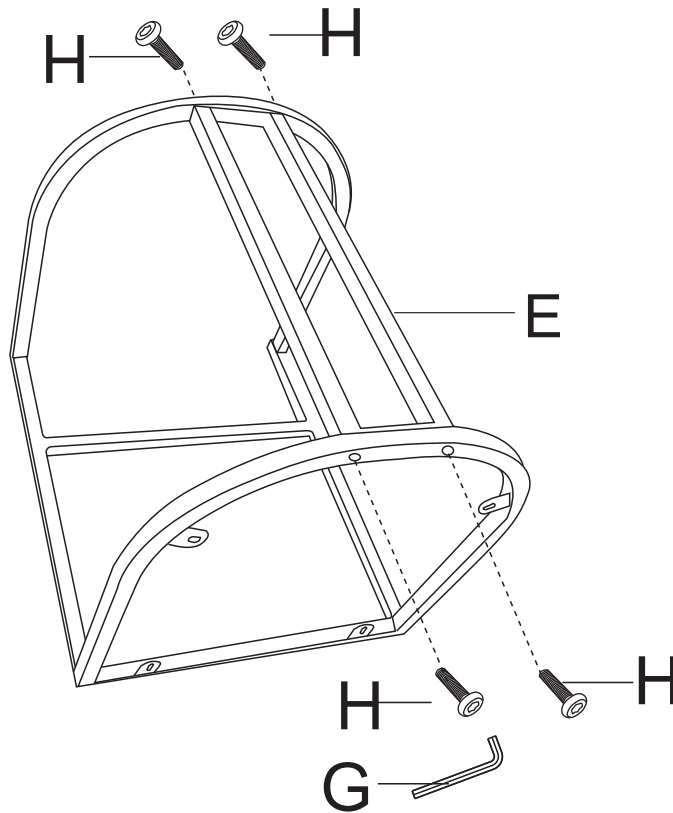

4

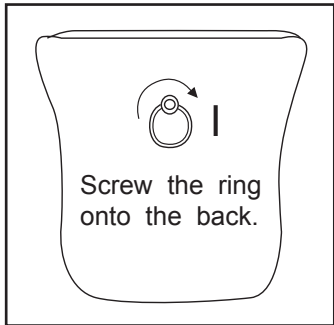
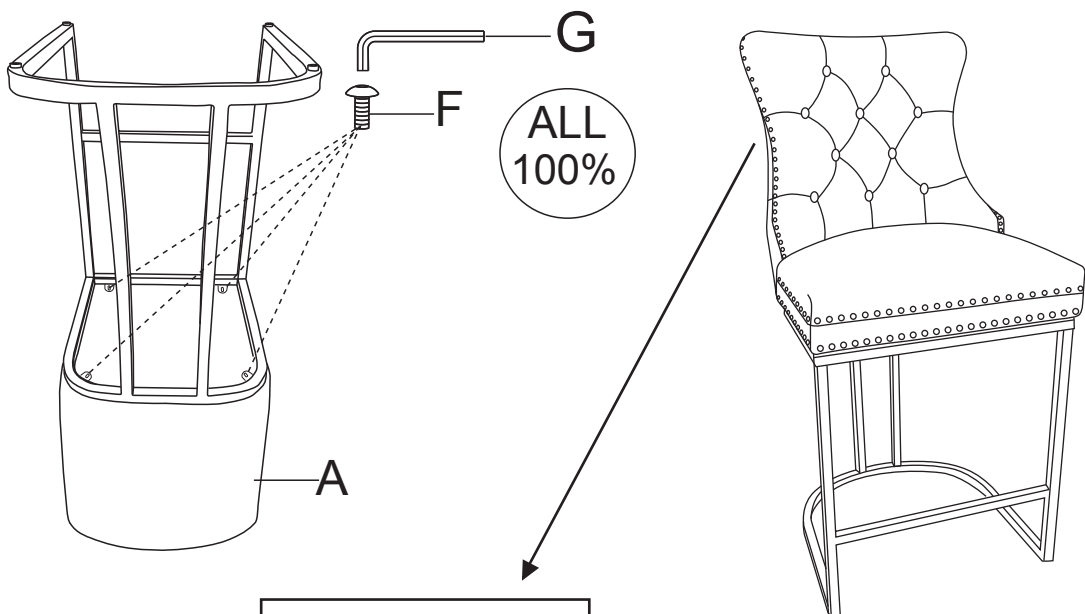

Adjust the adjuster bolt to keep the chairs level again.

**Are You Having Difficulty Assembling
This Product? Missing Parts?**

**PLEASE DO NOT RETURN
TO THE STORE!**

Call Our After Sales Support Hotline

1-875-512-8901

Monday- Sunday PST 09:00AM-18:00PM

Or Our Email Address

anjilinpai@outlook.com

Please contact us and mention your complete model number

Thank you for purchasing our product!