

INSTRUCTION MANUAL



ATTENTION

Thank you very much for your purchase.

When the number of your order is more than 1, we will split your order and ship the goods separately to ensure the safety.

We promise to deliver at the same time, but the time of receipt may be slightly different due to logistics. Each tracking number corresponds to only one cargo, you can contact us for more logistics information.

Thanks again for your understanding.

PARTS LIST

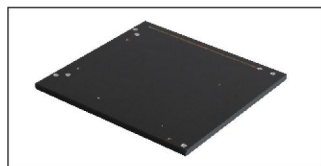

①X1 Left side panel

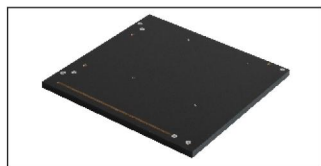

②X1 Right side panel



③X1 Front decorative panel

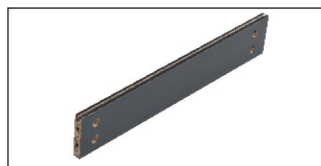

④X1 Rear decorative panel



⑤X1 Middle trim panel

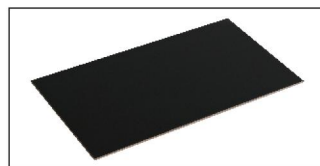

⑥X1 Back panel-1



⑦X1 Left trim panel



⑧X1 Right trim panel



⑨X1 Back panel-2



⑩X1 Top panel

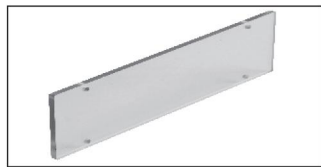

⑪X2 PC panel



⑫X3 Drawer left



⑬X3 Drawer right



⑭X3 Drawer back

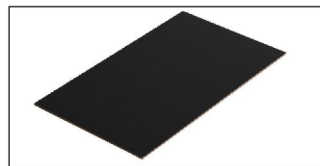

⑮X3 Drawer bottom



⑯X1 Drawer front-1



⑰X2 Drawer front-2

HARDWARE LIST



A 44+3 SET

Cam Bolt & Cam Lock



B 10+2 SET

Wood dowel 30mm



C 8+2 PCS

Screw-1 16mm



D 3 SET 12PCS

Slide rail 250mm



E 6+1 SET

Rear panel hook & screw



F 24+3 PCS

Screw-2 14mm



G 44 PCS

Hole cover



H 1 PCS

Screw driver

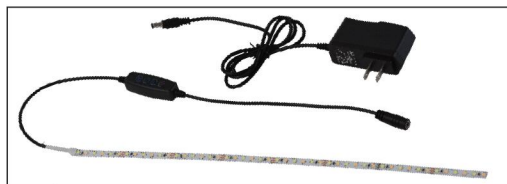

J 1 SET

Light strip



Spare 5 PCS

Inset Nut

If the nut is missing from the panel, use a hammer to drive in the spare nut.



ATTENTION

1. Please place the product on the carpet or carton to assemble to avoid scratching the floor;
2. During the installation process, keep away from children and pets, and avoid accidentally swallowing spare parts;
3. It is recommended to use a low-speed electric drill for installation.

step 1.

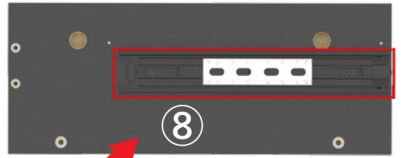
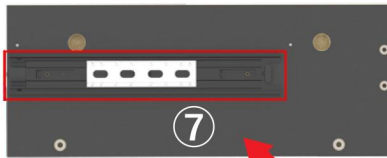
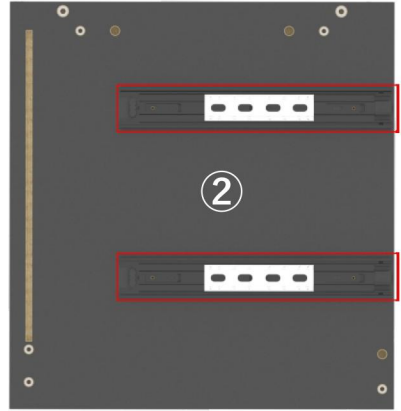
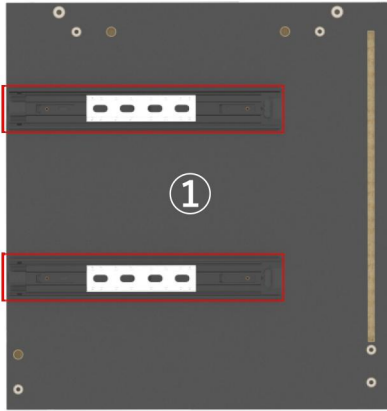

Please check the direction of each slide first!
Please carefully review the red markings on the slide rails in the manual!

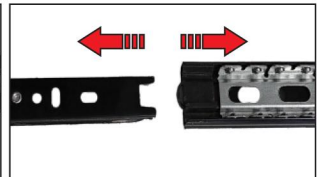
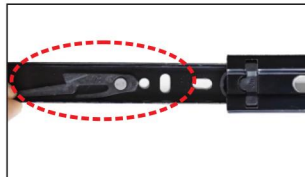
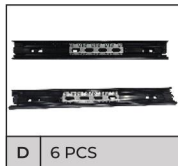
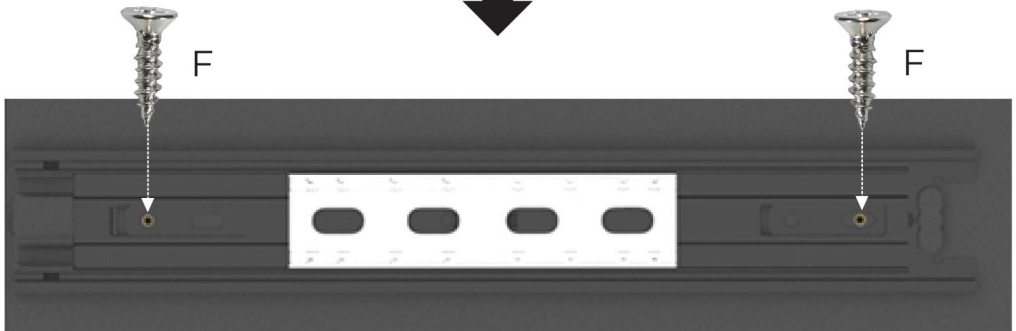

step 2.



(Attention: Cam bolt & Insert nut need to be put together)



A 3 SET

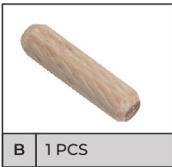

B 1 PCS

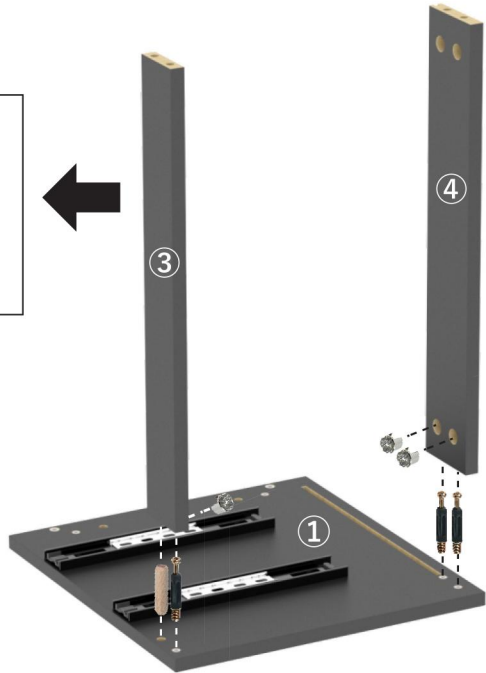

step 3.



A 2 SET

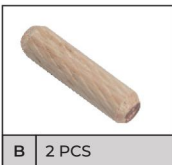

B 2 PCS

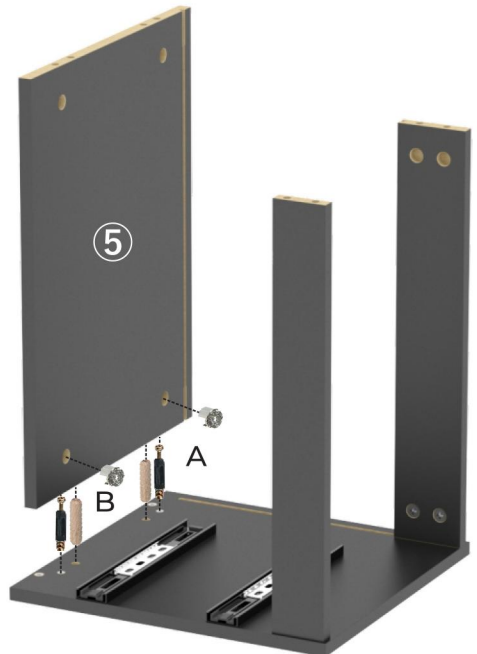

step 4.

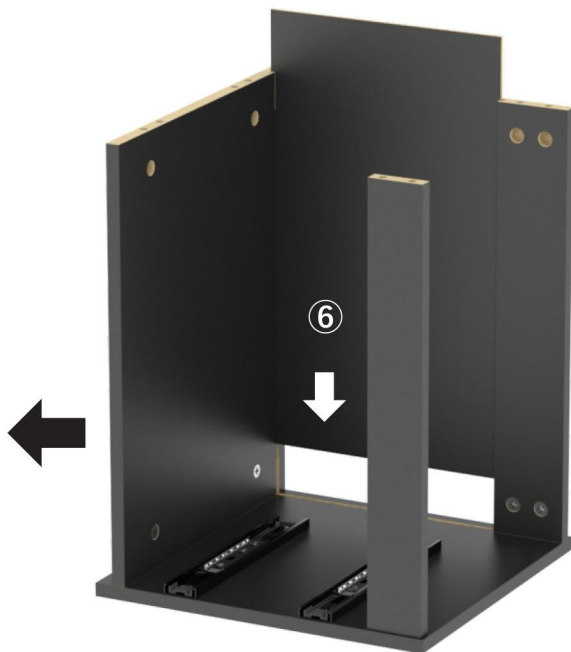

step 5.



A 5 SET

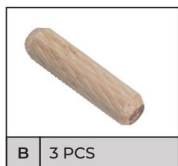

B 3 PCS

step 6.



A 4 SET



step 7.



A 6 SET

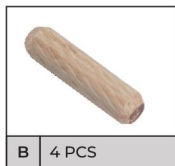

B 4 PCS



step 8.

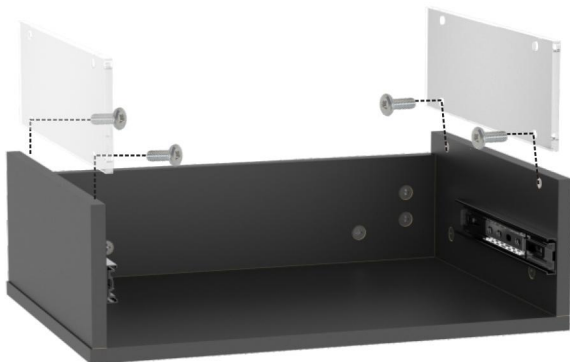

C 4 PCS

step 9.

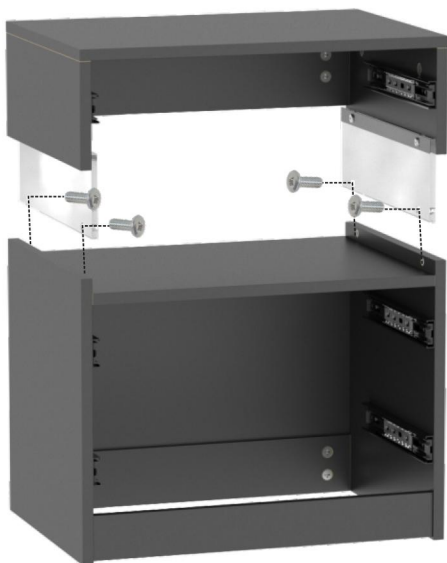

C 4 PCS

step 10. X3

DRAWER INSTALLATION

1 Connect part 12 & 13 to 14

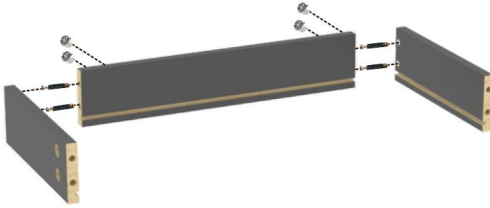

2 Insert part 15

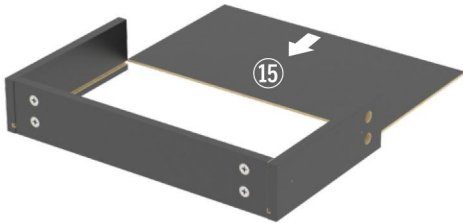

3 Connect Part 16



4 Install hardware "D" to part 12 & 13 according to the pre-drilled holes



Top 1 drawer



Bottom 2 drawers



A 24 SET



F 12 PCS



D 6 PCS

step 11.

Paste the light strip inside the 9th back panel for testing.
You can choose to paste it from left to right or from right to left.
Note: If the light strip is not pasted correctly, it should be gently removed and avoid using too much force to prevent the lightstrip from breaking. If the light strip is not on or damaged, please contact the online seller in a timely manner.

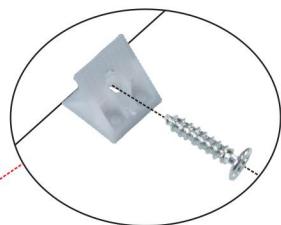
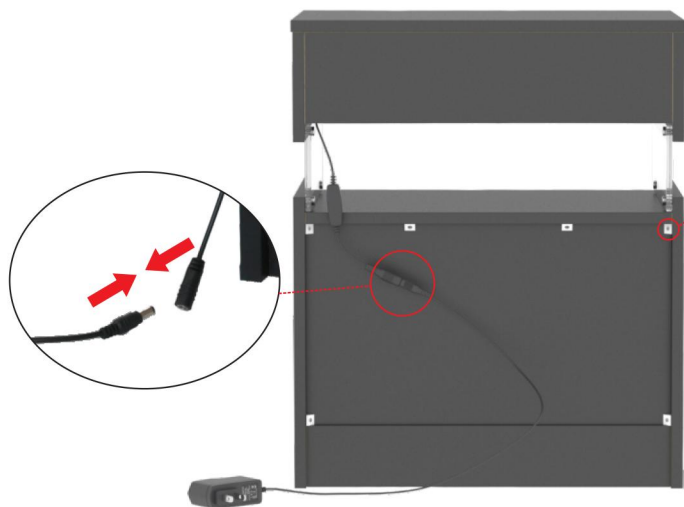
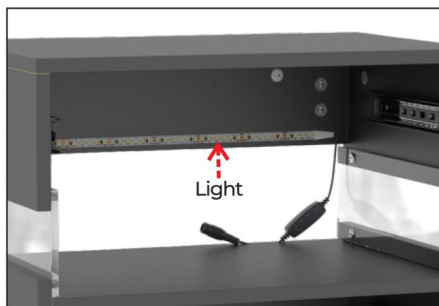
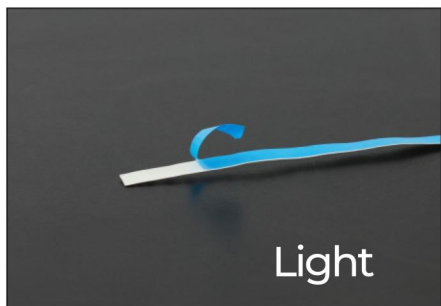

As the picture shows.
Fix hardware "E" into the gap with screwsto
make the back panel more stable.



step 12.

Please stick the hardware "G" on the exposed cam lock hole that makes your product more beautiful.

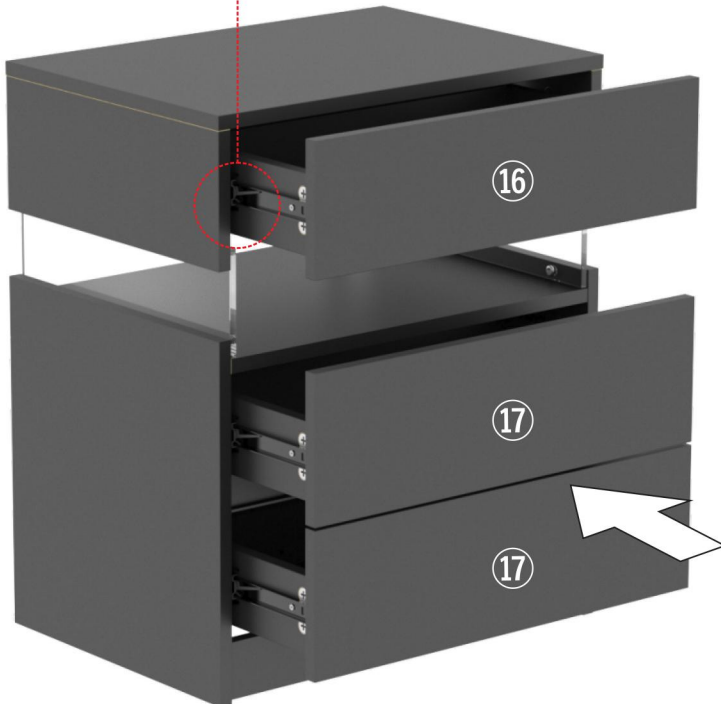
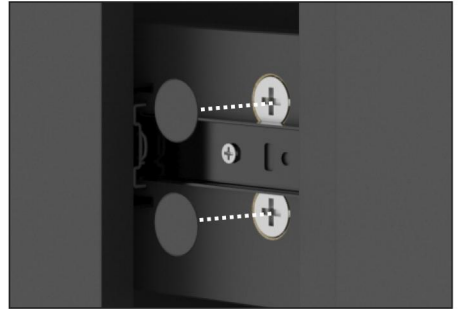
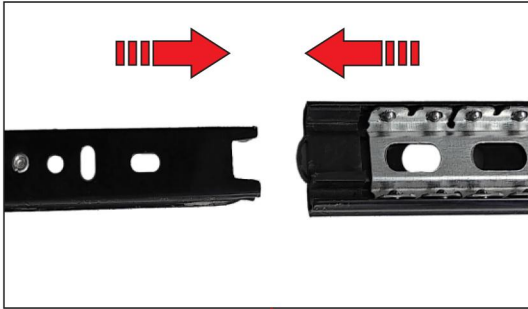



Congratulations on successful installation!!!

THANK YOU VERY MUCH FOR YOUR PURCHASE.

Save money. Buy smart.