











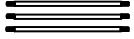

Installation Instruction

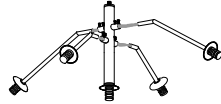
Part List and Hardware List

PIECE	PICTURE	DESCRIPTION	QUANTITY
A		Hanging plate	1X
B		Self-tapping screw	2X
C		Ceiling plate	1X
D		M4 nut	2X
E		suspender rods	3X
		suspender rods	1X
F		Lamp body	1X

PIECE	PICTURE	DESCRIPTION	QUANTITY
G		Glass lampshade	5X
O		Wire connector	3X
P		black wire	1X
Q		white wire	1X
R		Earth wire	1X

1

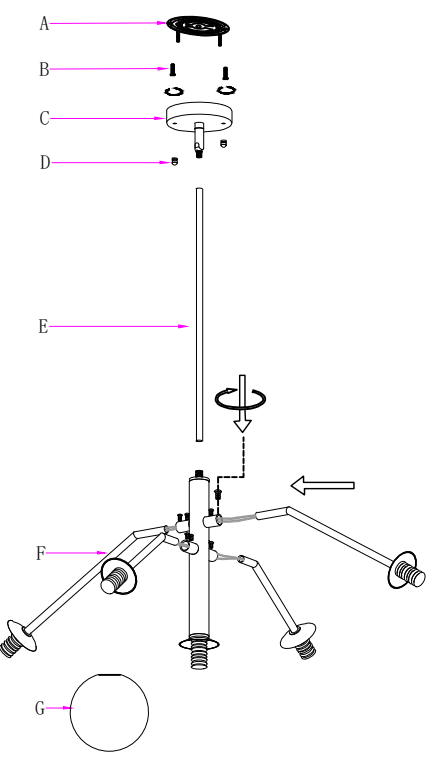

Step 1:

1. Fix the hanging plate (A) into the ceiling with self-tapping screws (B).
2. Then, connect the suspender rods (E) with the lamp body (F), and the Ceiling plate (C).

2

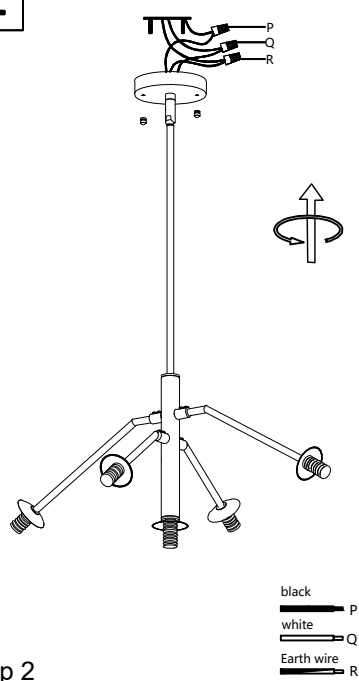

Step 2

1. Connect the power wire of lamp body to the reserved Power cable, pay attention to the positive and negative pole
2. After connecting the wires properly, use M4 nuts (D) to fix the lamp body on the ceiling.

3

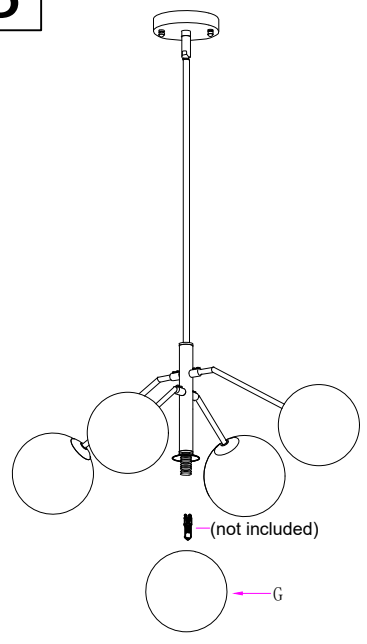

Step 3:

1. Finally, install the G9 light bulb (not included) and glass lampshade (G) to complete the installation.