

Owner Manual

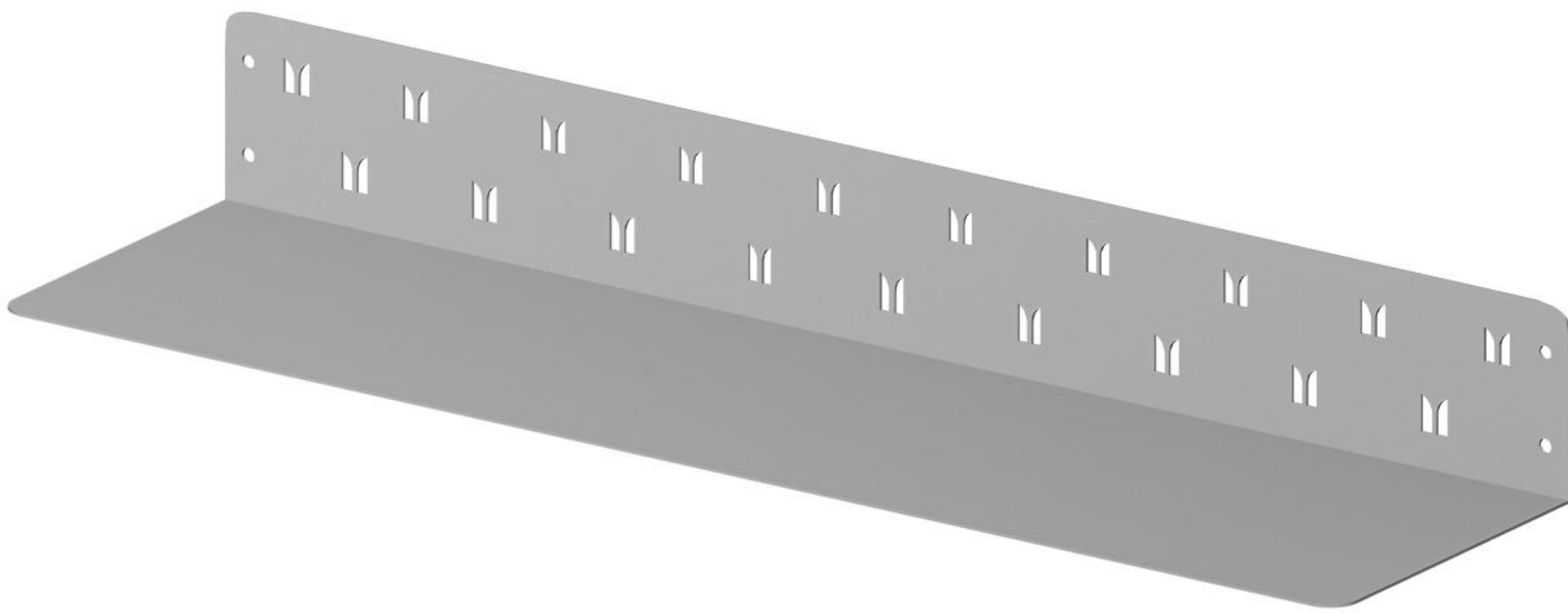

10 : 00

estimated
installation time



1 or more

people required

Ok, let's
get started!



- Put on mood music!
- To prevent damage to product, use the clean side of package carton or rug as working surface for assembly.
- In the event of missing or damaged parts, delivery problems etc., please reach out to our team. We will be happy to fix the problem!

care guide

- Clean regularly with a soft and dry cloth.
- To protect finish, avoid use of abrasive cleaners.
- Wipe up spills immediately. Please!



product
parts

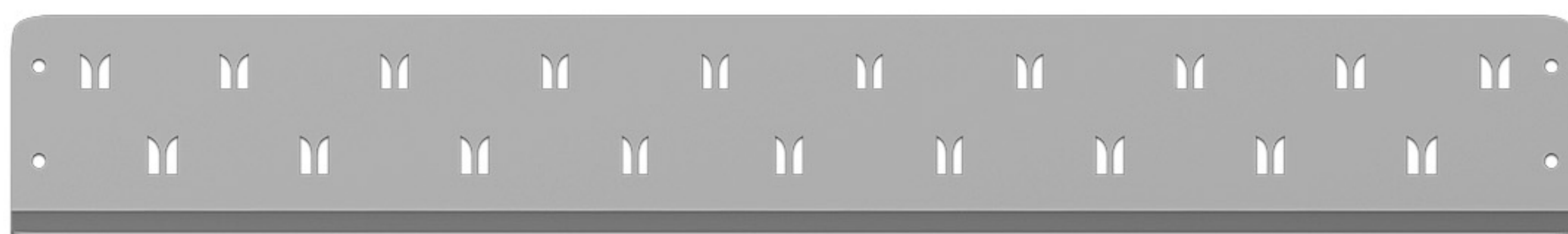

A
Shelf
x1

what's included

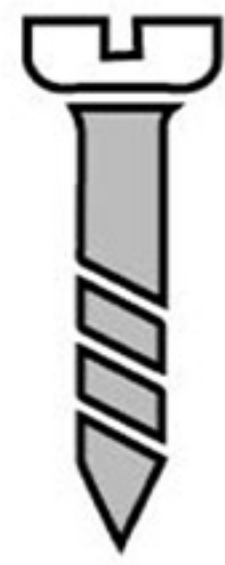

(B)- Screw
x4



(C)- Wall Plug
x4

installation instructions

Take a deep breath going in.
This is easy even if you are not
used to tools. Just follow these
steps to the T, and the
outcome will be
worth it!



step 1:

Place the shelf on the and put a spirit level on it to check the alignment. Adjust if needed.

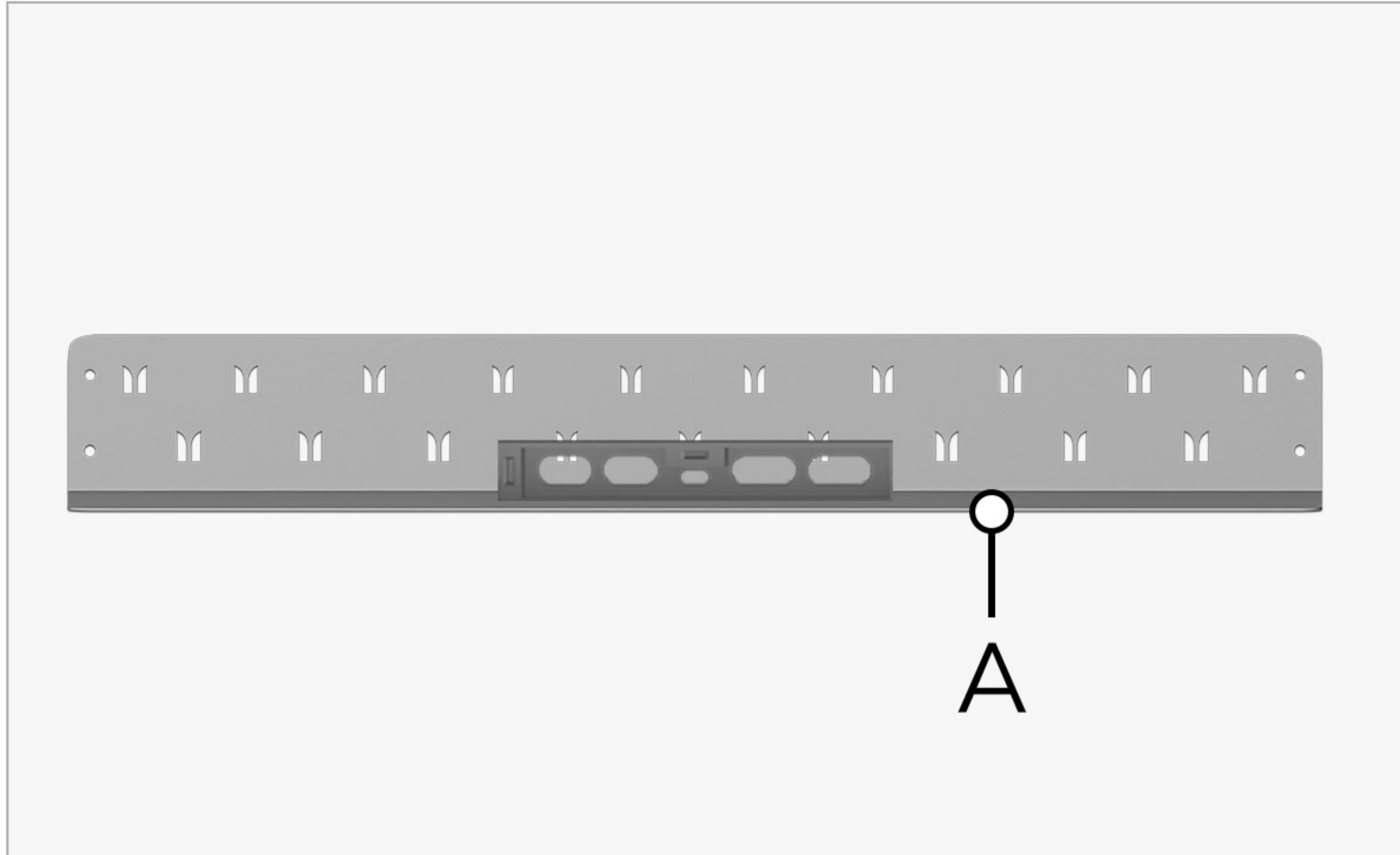

step 2:

Once the shelf is straight to the wall, make two points using a pencil, taking this image as reference.

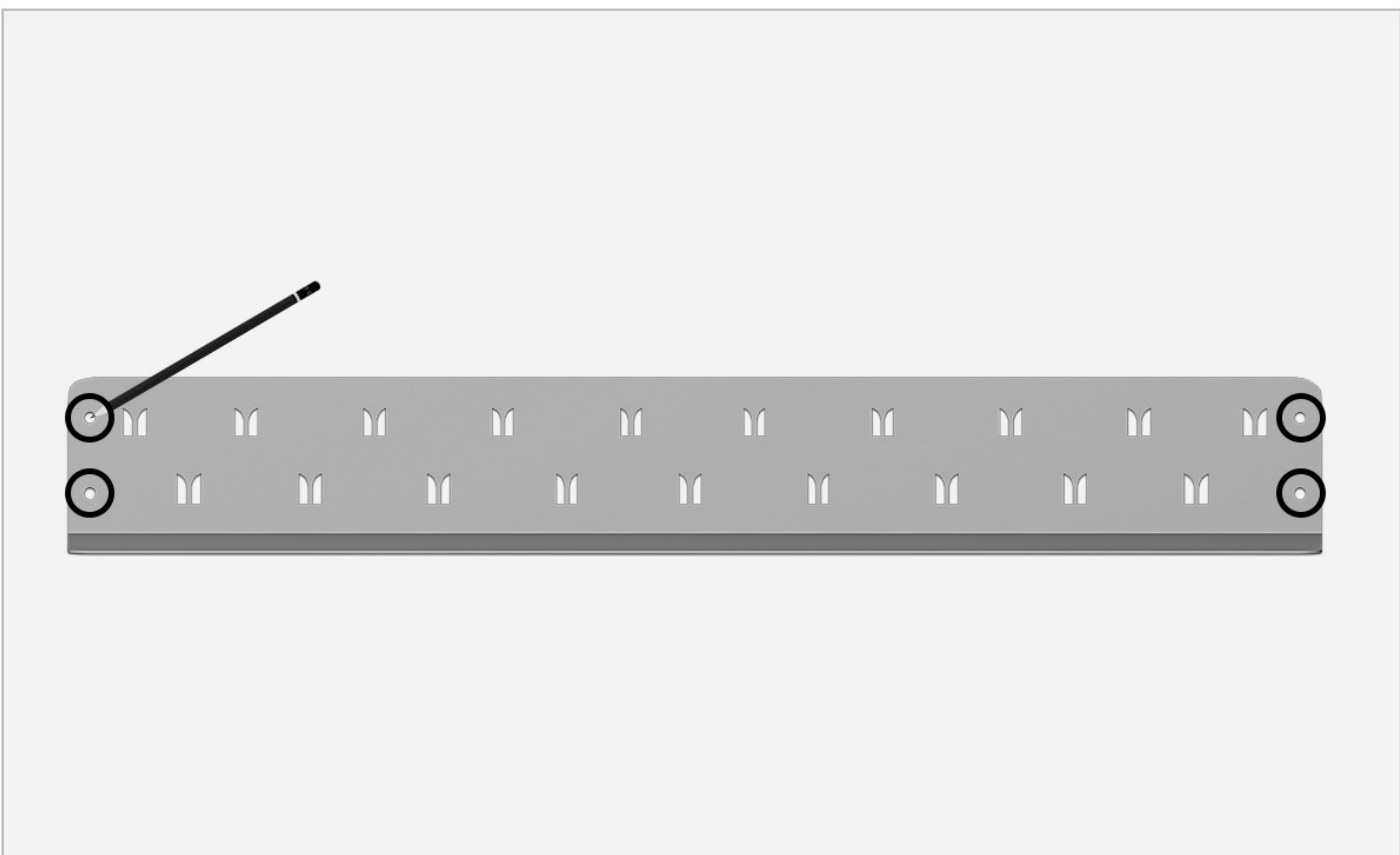

step 3:

Drill holes approx. 10 mm at the points you just marked.



step 4:

Insert the wall plug (C) and tighten with the help of a screwdriver.

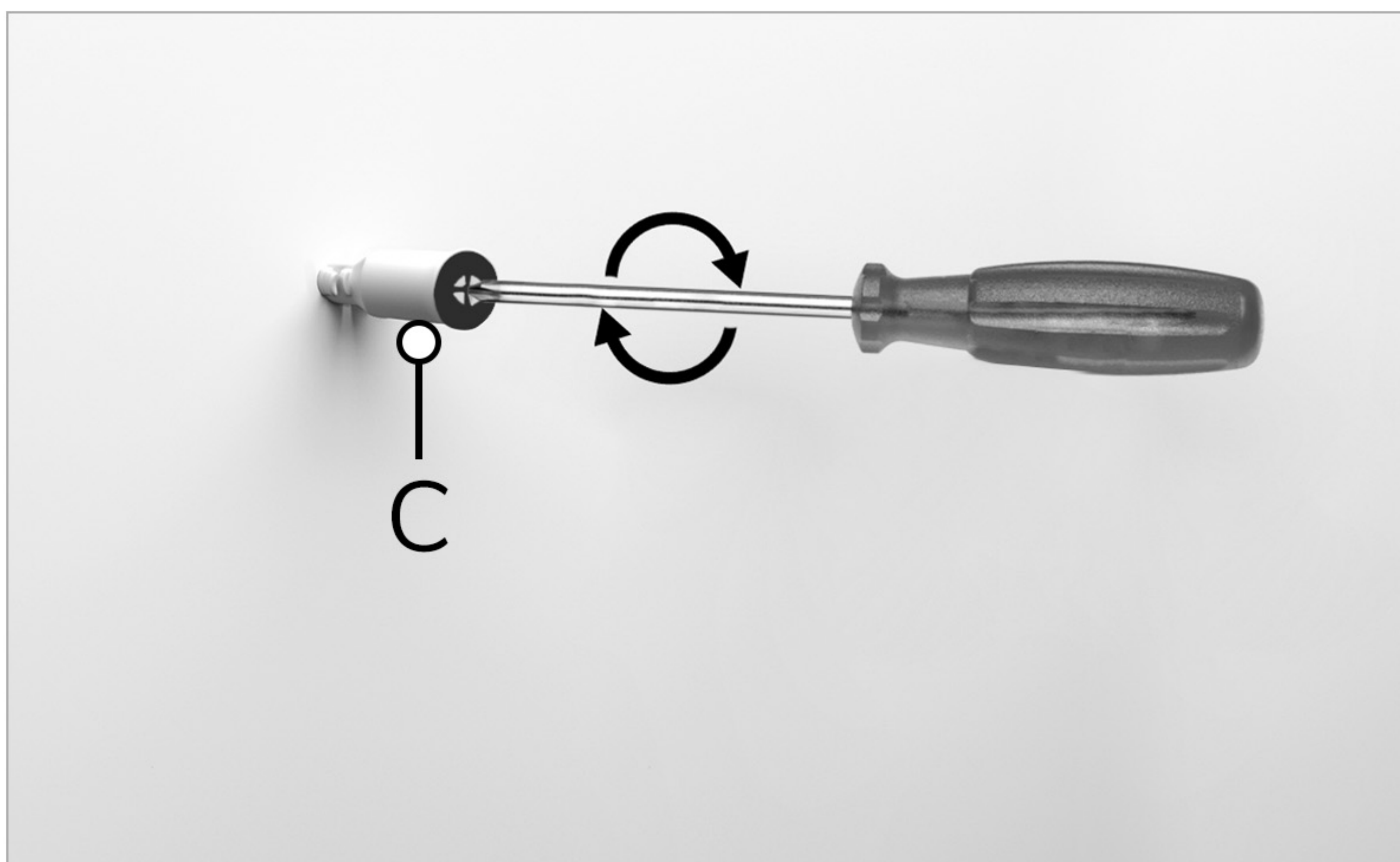

step 5:

Now, align the shelf & screws (B) and tighten all the screws with the help of a screwdriver.

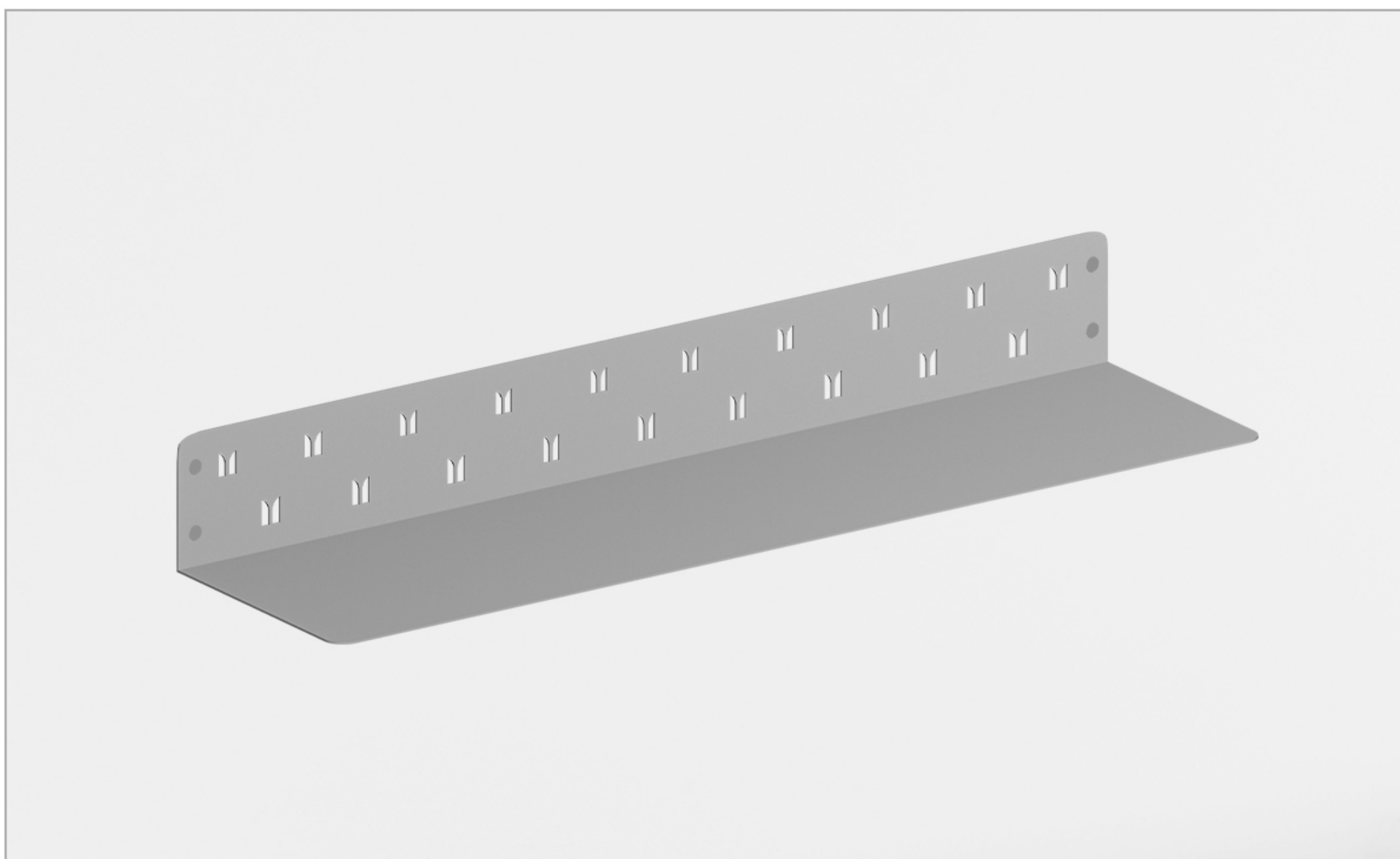
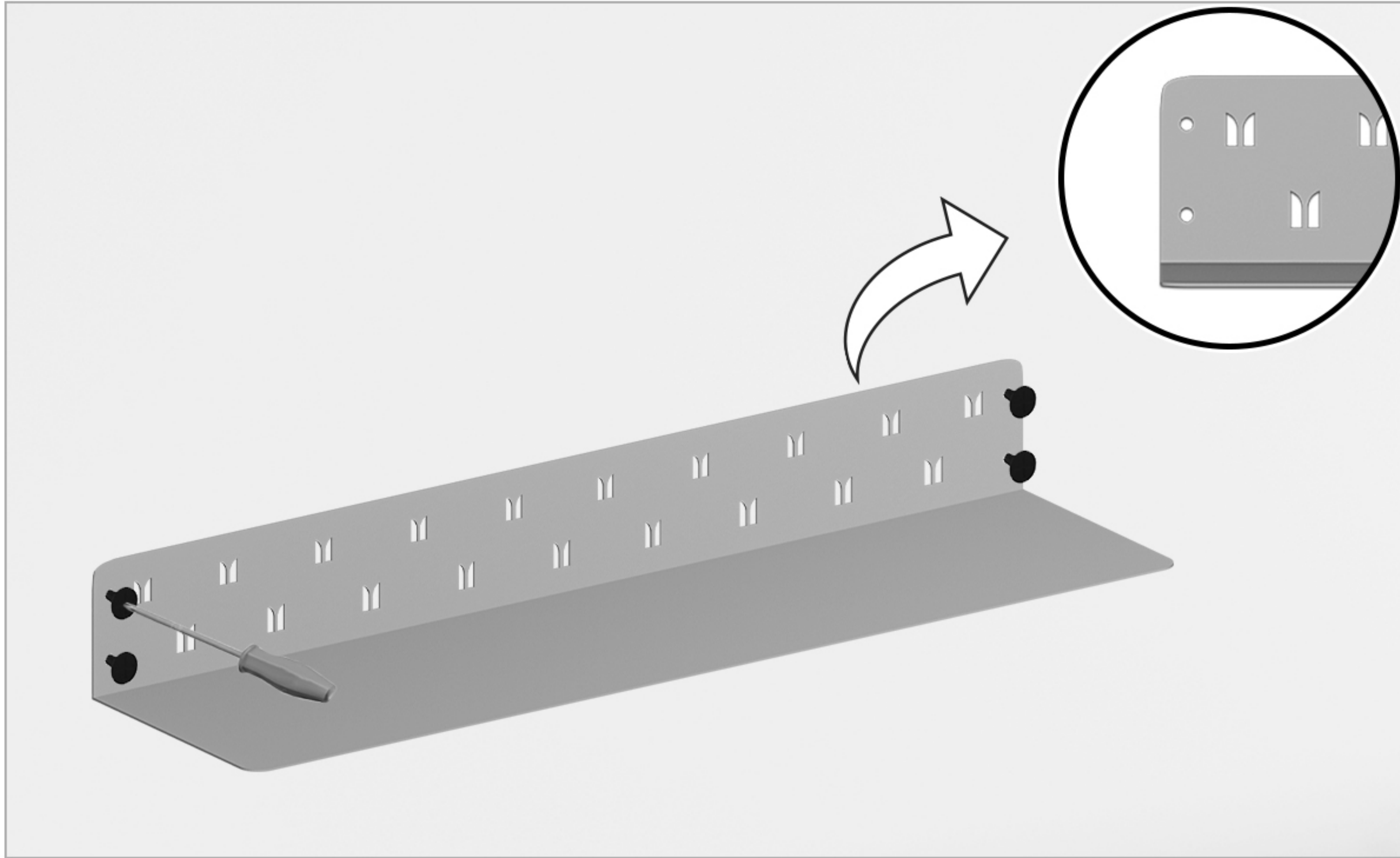

Voila! Your shelf is now installed and secure!