

User's Manual

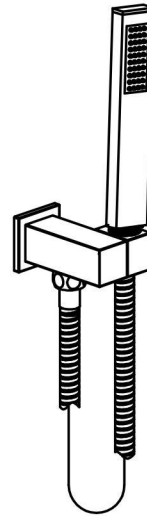

INSTALLATION INSTRUCTIONS

Installation Manual

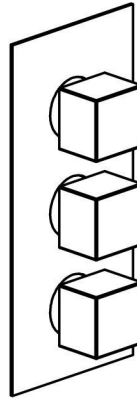
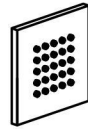
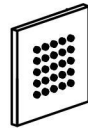
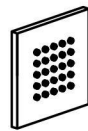
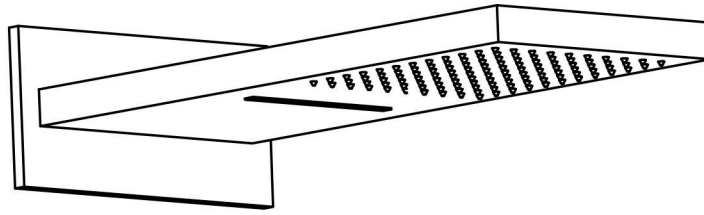

IAPMO RESEARCH AND TESTING, INC.
5001 East Philadelphia Street, Ontario, California 91761-2816 - USA • 909-472-4100 • 909-472-4244 • www.iapmort.org

CERTIFICATE OF LISTING

C  IAPMO Research and Testing, Inc. is a product certification body which tests and inspects samples taken from the supplier's stock or from the market or a combination of both to verify compliance to the requirements of applicable codes and standards. This activity is coupled with periodic surveillance of the supplier's factory and operations as well as the assessment of the supplier's Quality Assurance System. This listing is subject to the conditions set forth in the characteristics below and is not to be construed as any recommendation, assurance or guarantee by IAPMO Research and Testing, Inc. of the product compliance by Authorized Testing Jurisdiction.

This certificate is not evidence of current listing. To verify listing status, visit the IAPMO R&T Product Listing Directory at pld.iapmo.org

Effective Date: December 2019 -Rev. 2/24/2020- Void After: December 2024
Product: Flexible Water Connectors File No. 5111
Issued To: Fanaki Group Inc.
Mechanical & Electrical
Industrial Zone,
Yuhuan County,
Yuhuan 317600, ZHEJIANG
China

Identification: Products shall be marked with manufacturer's name or trademark, a statement "For use with water in accessible locations only." The products shall also bear the cUPC® certification mark. Markings shall be by means of either a permanent mark on the product, a label on the product or a tag attached to the product.

Characteristics: Flexible water connectors manufactured in various sizes, lengths and metal and fittings for hot or cold water applications that consist of an inner tube, which may or may not have an outer braided cover. Connectors are to be installed for use in accessible locations only. To be installed in accordance with the manufacturer's instruction, and the latest edition of the Uniform Plumbing Code and National Plumbing Code of Canada.

Products listed on this certificate have been tested by an IAPMO R&T recognized laboratory. This recognition has been granted based upon the

 
Chairman, Product Certification Committee CEO, The IAPMO Group

This listing is based upon the test data of the month indicated on the Effective Date and Void After Date shown above. Any change in material, manufacturing process, marking or design without written prior consent of the Product Certification Committee, or any extension of manufacturing date without written prior consent of the Product Certification Committee, shall be considered as a violation of this listing. Production of or reference to this form for advertising purposes may be made only by specific written permission of IAPMO Research and Testing, Inc. Any alteration of this certificate could be grounds for revocation of the listing. This document shall be reproduced in its entirety.

IAPMO RESEARCH AND TESTING, INC.
5001 East Philadelphia Street, Ontario, California 91761-2816 - USA • 909-472-4100 • 909-472-4244 • www.iapmort.org

CERTIFICATE OF LISTING

C  IAPMO Research and Testing, Inc. is a product certification body which tests and inspects samples taken from the supplier's stock or from the market or a combination of both to verify compliance to the requirements of applicable codes and standards. This activity is coupled with periodic surveillance of the supplier's factory and operations as well as the assessment of the supplier's Quality Assurance System. This listing is subject to the conditions set forth in the characteristics below and is not to be construed as any recommendation, assurance or guarantee by IAPMO Research and Testing, Inc. of the product compliance by Authorized Testing Jurisdiction.

This certificate is not evidence of current listing. To verify listing status, visit the IAPMO R&T Product Listing Directory at pld.iapmo.org

Effective Date: November 2019 Void After: November 2024
Product: Plumbing Fixture Fittings File No. 10613
Issued To: Aqua Gallery Co., Ltd
118-118A Block
International Dynamics
Sanitary City, 528000
Foshan,
China

Identification: Plumbing supply fittings complying with this Standard shall be marked with the manufacturer's recognized name, trademark, or other mark or, in the case of private labeling, the name, trademark or other mark of the customer for whom the fitting was manufactured. The marking shall be accomplished by use of a permanent mark or by placing a permanent label on the product. Markings on plumbing supply fittings shall be visible after installation.

Single-handle, single-control, and automatic compensating mixing bath and shower valves shall have identifiable temperature control settings in which the settings are indicated by words ("cold", "warm", "hot", etc.), by numbers, or graphically.

Package shall be marked with the manufacturer's name, trademark, or other mark as well as the model number or, in the case of private

 
Chairman, Product Certification Committee CEO, The IAPMO Group

This listing is based upon the test data of the month indicated on the Effective Date and Void After Date shown above. Any change in material, manufacturing process, marking or design without written prior consent of the Product Certification Committee, or any extension of manufacturing date without written prior consent of the Product Certification Committee, shall be considered as a violation of this listing. Production of or reference to this form for advertising purposes may be made only by specific written permission of IAPMO Research and Testing, Inc. Any alteration of this certificate could be grounds for revocation of the listing. This document shall be reproduced in its entirety.

IAPMO RESEARCH AND TESTING, INC.
5001 East Philadelphia Street, Ontario, California 91761-2816 - USA • 909-472-4100 • 909-472-4244 • www.iapmort.org

CERTIFICATE OF LISTING

C  IAPMO Research and Testing, Inc. is a product certification body which tests and inspects samples taken from the supplier's stock or from the market or a combination of both to verify compliance to the requirements of applicable codes and standards. This activity is coupled with periodic surveillance of the supplier's factory and operations as well as the assessment of the supplier's Quality Assurance System. This listing is subject to the conditions set forth in the characteristics below and is not to be construed as any recommendation, assurance or guarantee by IAPMO Research and Testing, Inc. of the product compliance by Authorized Testing Jurisdiction.

This certificate is not evidence of current listing. To verify listing status, visit the IAPMO R&T Product Listing Directory at pld.iapmo.org

Effective Date: March 2019 Void After: March 2024
Product: Plumbing Fixture Fittings - Components File No. MC-9703
Issued To: Ningbo Nandai Cartridge Technology Co., Ltd.
Liaison Zone, Chunm
Fenghua 311030
China

Identification: Each fitting component shall bear permanent legible markings to identify the manufacturer. This marking shall be the trade name, trademark, or other mark known to identify the manufacturer. The product shall also bear all other markings required by the standards. The marking shall be applied so as to be visible after installation. The product or packaging shall also bear the cUPC® certification mark along with the term "COMPONENT" above.

Characteristics: Plumbing fixture fitting components to be installed in accordance with the manufacturer's instructions and the requirements of the latest edition of the Uniform Plumbing Code.

Products listed on this certificate have been tested by an IAPMO R&T recognized laboratory. This recognition has been granted based upon the Laboratory's compliance to the applicable requirements of ISO/IEC 17025.

Products are in compliance with the following code(s):
Uniform Plumbing Code (UPC®)

 
Chairman, Product Certification Committee CEO, The IAPMO Group

This listing is based upon the test data of the month indicated on the Effective Date and Void After Date shown above. Any change in material, manufacturing process, marking or design without written prior consent of the Product Certification Committee, or any extension of manufacturing date without written prior consent of the Product Certification Committee, shall be considered as a violation of this listing. Production of or reference to this form for advertising purposes may be made only by specific written permission of IAPMO Research and Testing, Inc. Any alteration of this certificate could be grounds for revocation of the listing. This document shall be reproduced in its entirety.

BEFORE INSTALLATION

Precautions and Maintenance

1. In order to ensure the durability of the product, please be as gentle and slow as possible during operation.
2. Clean the filter regularly.
3. When the shower is used for a long time and water is found to flow out intermittently there must be debris blocking the water outlet. At this time, you only need to gently touch & clean the soft rubber tips on the shower, then the debris will be automatically rushed out.
4. If any dirt on surface, clean with soft liquid or transparent glass detergent, then rinse it with soft water, finally gently wipe it with a dry soft cloth.
5. Do not use any scrubbing detergent, polisher, sand -cloth, paper tissue, or scraper.
6. Do not use acid detergent, insoluble & grain-like detergent or soap.
7. If you will not use the shower for a long time, please close the main water inlet valve in your home.
8. When the ambient temperature is under 0° C/32° F, please take necessary measures to keep the water equipment warm.

Piping Diagram

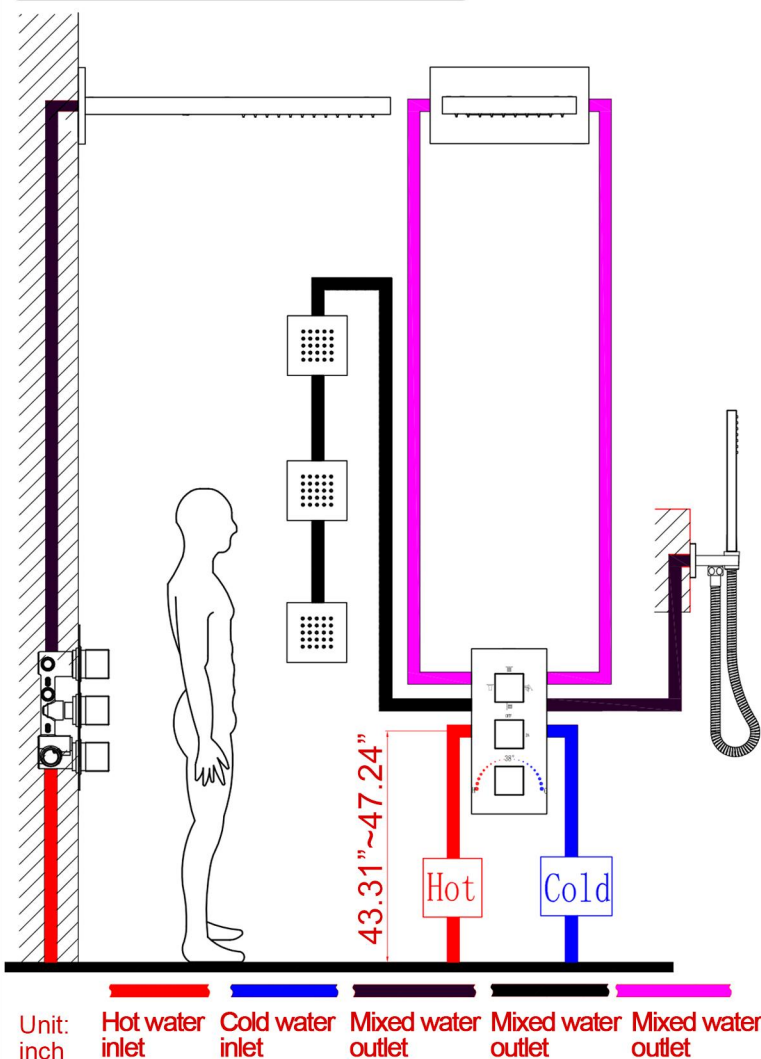

Installation of Main Body Parts list

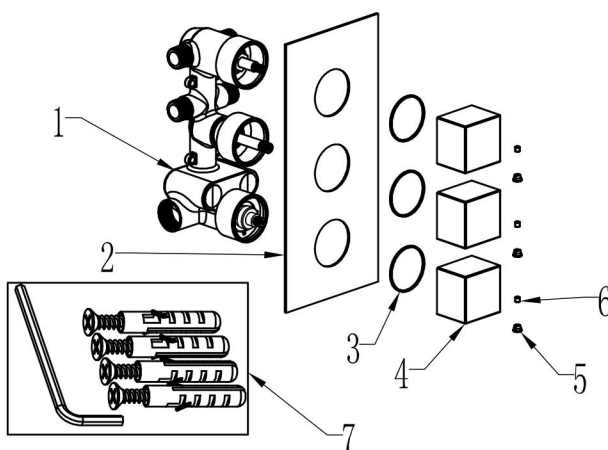

NO.	Description	Quantity
1	Valve Body	1
2	Faceplate	1
3	Rubber O-ring	3
4	Handle cover	3
5	Hexagon socket screw	3
6	Decorative cap	3
7	Kits bag	1

INSTALL THE SHOWER VALVE BODY

This product has been inspected and debugged by the factory to the best condition. Please do not disassemble and assemble it yourself.

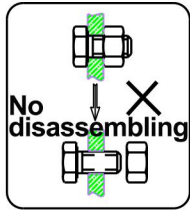

Before installing the product, please be sure to remove sundries and sludge from the water pipe to prevent sundries from blocking the product.



1. Unscrew the decorative screws, counter-clockwise and pull them out, then use the Allen screw to remove the hexagon socket screws.

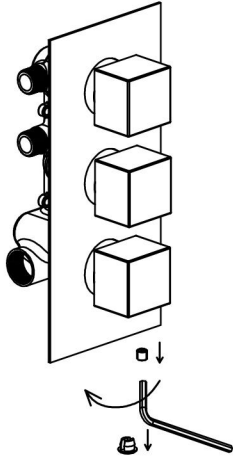

2. Remove the face plate, take apart the valve into 3 parts as shown in the picture.

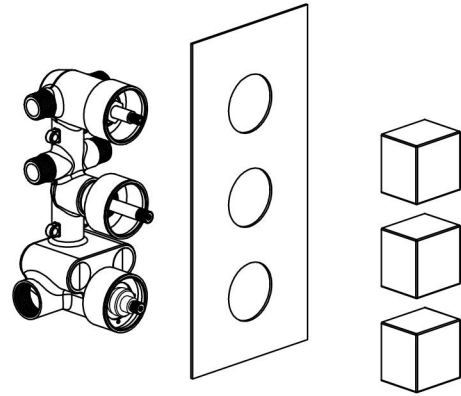

3. With reference to the basic dimensions of the embedded body, excavate the embedded ports of the main body, hot & cold water inlet pipe and the outlet pipe.

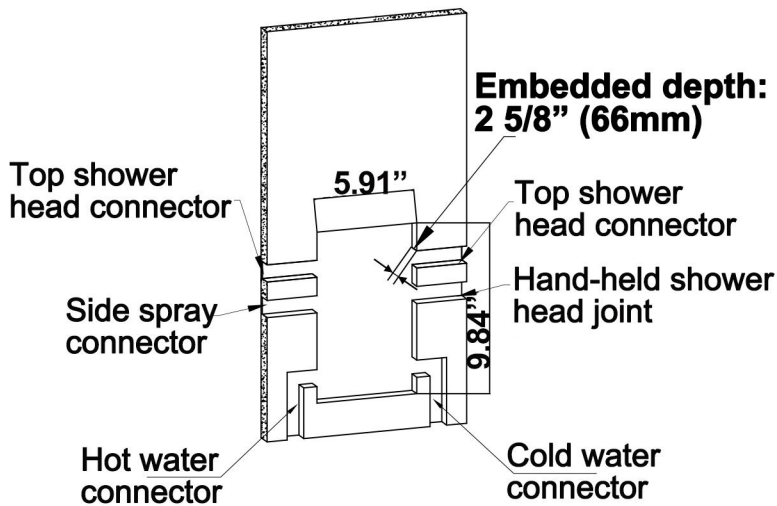

4. Drill four 6mm positioning holes according to the product size.

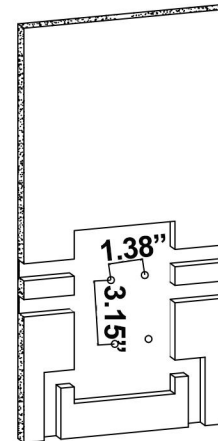

5. Hammer the expanded screw in the 4 drilled holes.

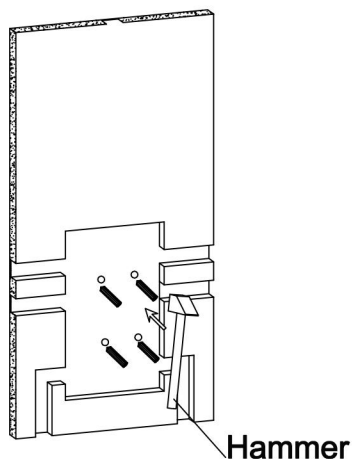

6. Position the valve body on the 4 screws.

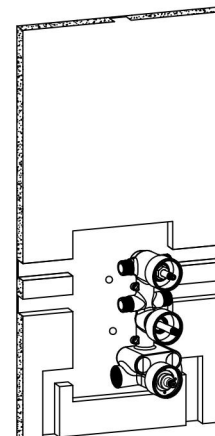

INSTALL THE SHOWER VALVE BODY

7. Use a Phillips screwdriver to tighten the 4 self-tapping screws, fix the valve body on the wall.

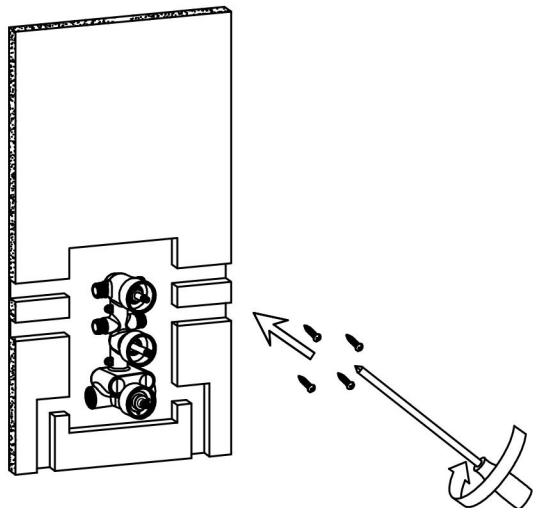

8. Connect all the pipes to check leakage, confirm no leak occurs when turn on water.

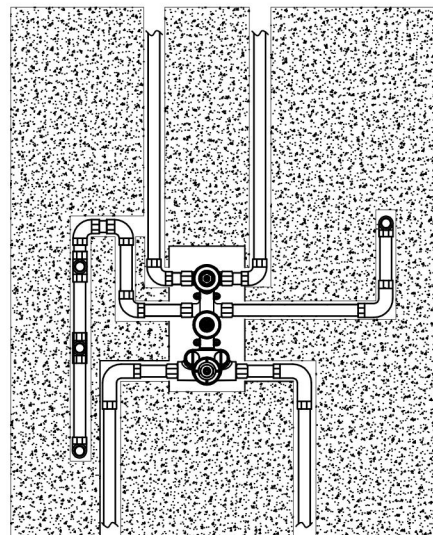

9. Fix the decorative plate and knobs on the valve body. Screw the hand-wheel on the handles and tighten with a Allen wrench.

10. Insert 3 decorative screw into the knobs.

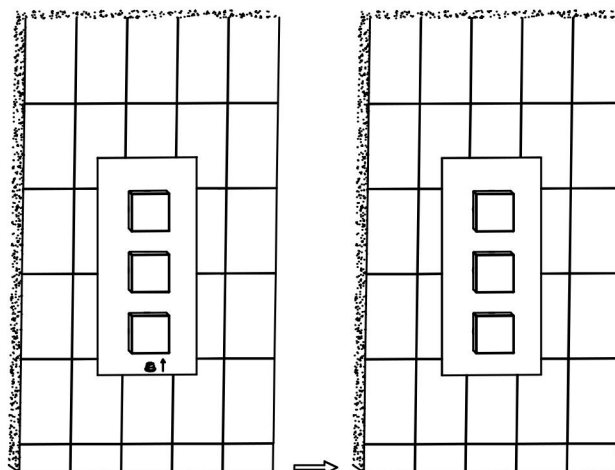
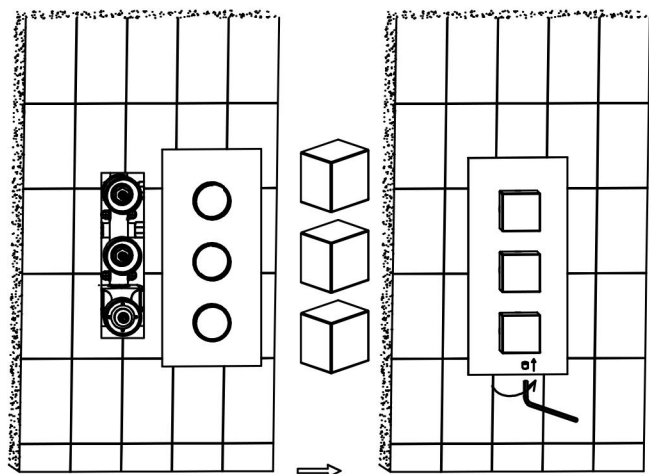

INSTALLATION OF THE HAND SHOWER

1. Wrap the PTFE tape on the 1/2 thread of the stand for shower head.

2. Screw the stand for shower head clockwise on the outlet hole of the water outlet.

3. Connect the water outlet of the stand for shower head with the tube of shower head, and put the hand-held shower head in the stand.

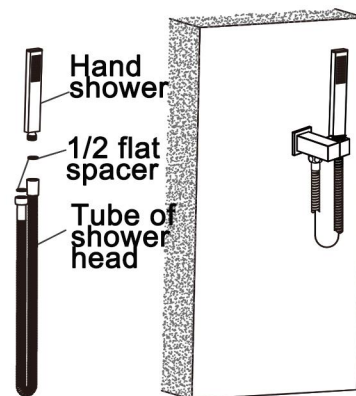
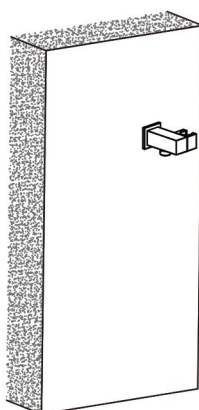
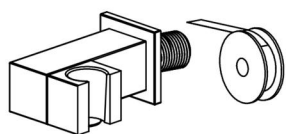

INSTALLATION OF RAIN SHOWER HEAD

Parts list

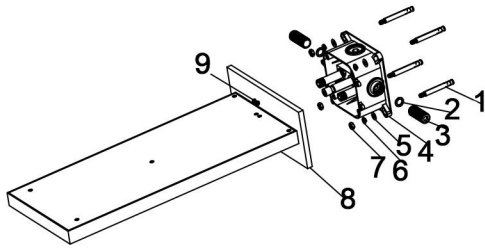

NO	Name	Qty	NO	Name	Qty
1	Expansion screws	4	6	Spring gasket	4
2	1/2 washer	2	7	Security screw	4
3	Connector	2	8	Showerhead part	1
4	Embedded body	1	9	M6x8 screw	2
5	Washer	4			

Sketchy diagram

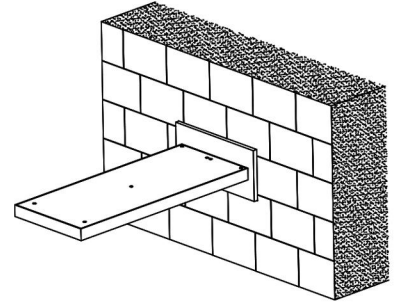

1. When customer receives the product, loosen the M6X8 screw with an Allen key as shown above.

2. Then separate the parts of the shower head from the pre-burying main body.

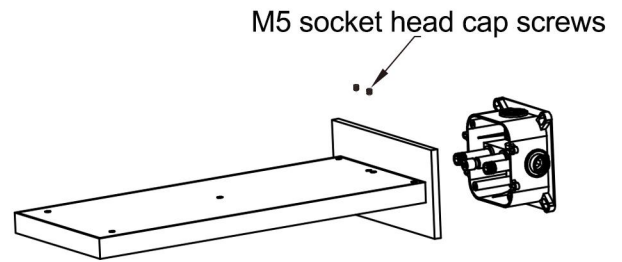
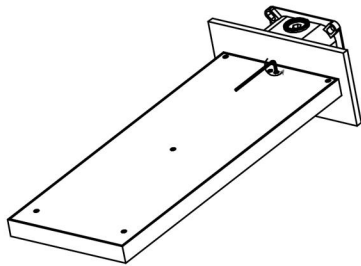

INSTALLATION OF RAIN SHOWER HEAD

1. With reference of above size, excavate a pre-embedded groove in the appropriate position on the wall.

2. With reference of the basic size of the product, drill four Ø0.4" (10mm) holes in the appropriate position on the wall.

3. Drive four explosive bolts into the drilled holes with a hammer.

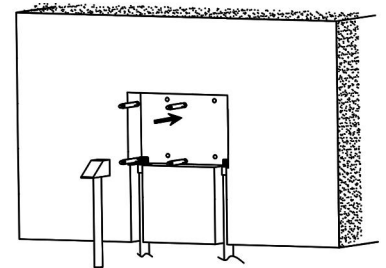
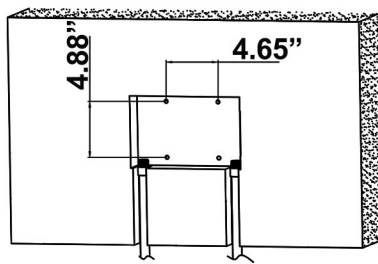
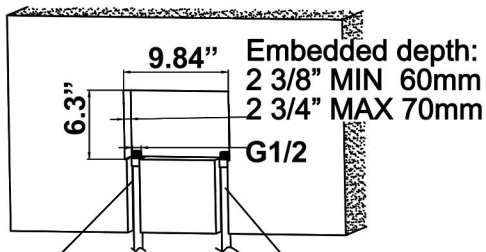

Connect the rain shower head

Connect the waterfall water outlet

4. The pre-embedded body is supported by hand and installed on the four explosion bolts.

5. Rely on the spirit level to adjust the embedded main body on the horizontal line, use a sleeve to lock the 4 nuts to fix the embedded main body on the wall.

6. Put 1/2 flat spacer into the pre-embedded main body and tighten the water inlet joint.

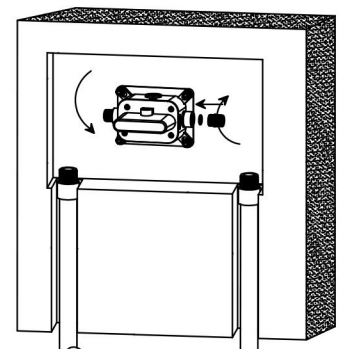
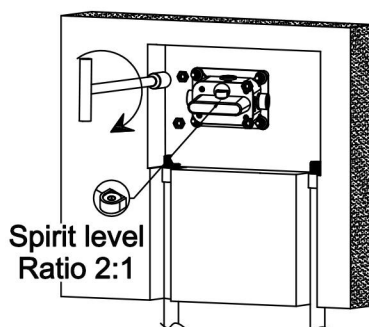
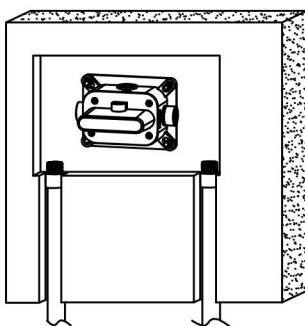

INSTALLATION OF RAIN SHOWER HEAD

7. Connect the water pipe to the pre-embedded main body to confirm there is no leakage.

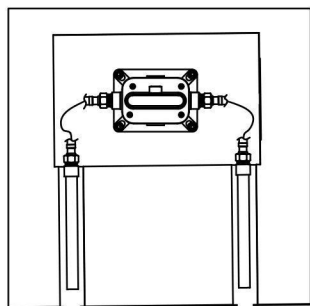

8. Tile or other decorative materials will be pasted on the wall and size shown above should be reserved.

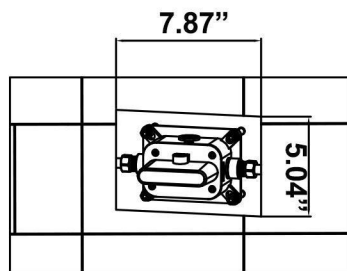

9. Remove the protective cover with a screwdriver.

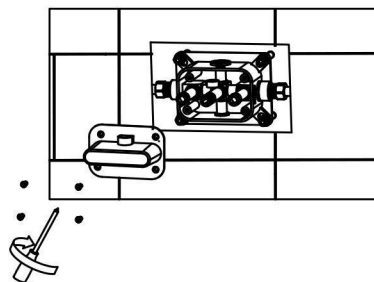

10. Insert the parts of shower head into the pre-embedded main body according to the corresponding hole.

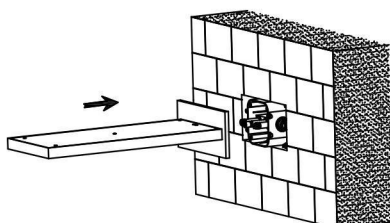

11. Tighten the parts of shower head with N6X8 screw and a hexagonal wrench.

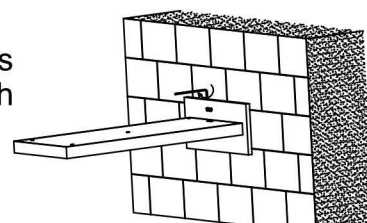

INSTALLATION OF SIDE SPRAY

1. Use a hexagonal wrench to turn counterclockwise to remove the 1/2 threaded joint.

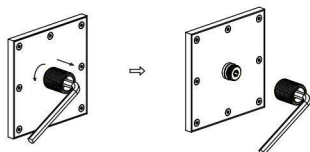

2. Wrap the PTFE tape on the 1/2 threaded joint.

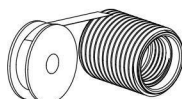

3. Use a hexagonal wrench to rotate clockwise to install the 1/2 threaded joint on the wall side spray joint. (Note: The 1/2 threaded joint has an internal threaded end facing outward).

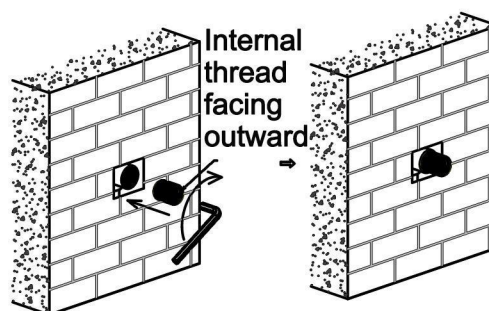

4. Rotate the side nozzle clockwise and tighten it on the 1/2 threaded joint.

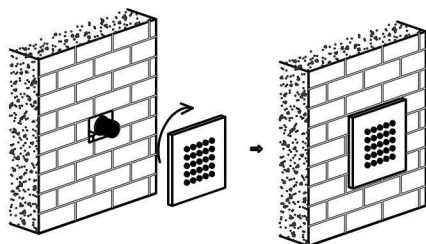

5. Install the remaining side sprinklers according to the previous steps.

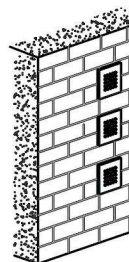

CLEANING CARE

In order to keep the appearance of product clean, bright and good performance, please take care of the product as follows;

1. Rinse with water only and dry with soft cotton cloth;
2. Use mild liquid and colorless glass cleaner to remove surface dirt and scale film, or use polish without abrasive effect;
3. Do not use abrasive detergent, polish, emery cloth, paper towel or scraper, etc;
4. Do not use acid cleaner, or cleaner and soap with insoluble gran etc;
5. In the process of use, mud may accumulate in the bubbler and make the water flow slow, The bubbler can be unscrewed, rinsed with water, and then installed back in place.



