

INSTALLATION INSTRUCTIONS

DeerValley®

Sliding Shower Door

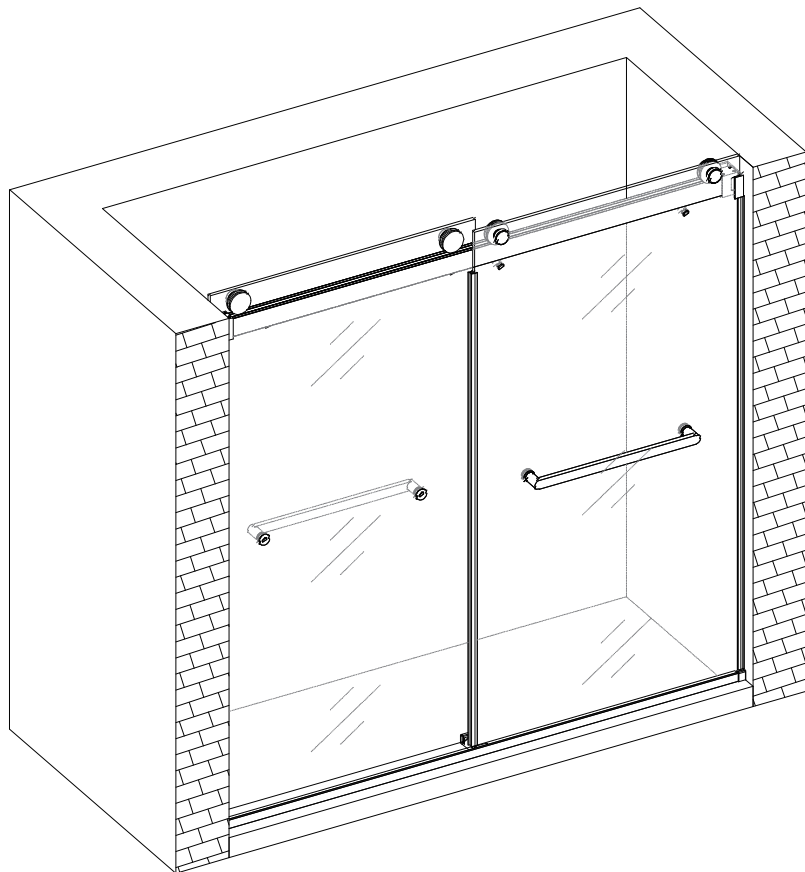

Watch the Installation Video

SCAN THE QR CODE BELOW TO WATCH THE STEP-BY-STEP INSTALLATION GUIDE

This video provides a detailed demonstration to help you complete the installation.



 <https://youtu.be/1zATxrP3iCo?si=Qm9nnpd1vkG2RLLMV>

If the QR code doesn't work, please enter this URL in your browser.

TIP : We recommend watching the full video before starting the installation.

Product Breakdown Diagram

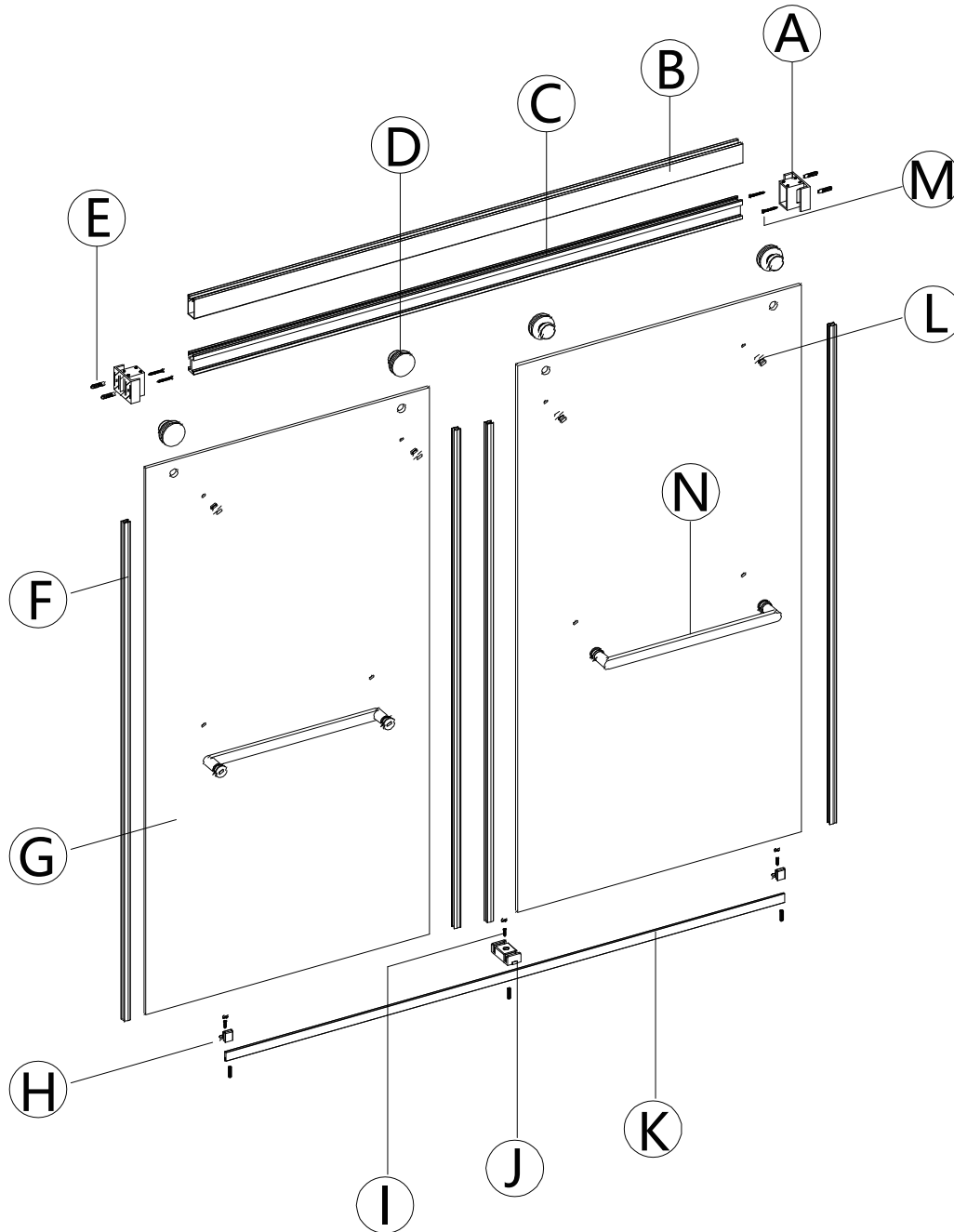

**If you have any questions or concerns
please contact us:**

(312) 626-9466
service@deervalleybath.com

Delivery Notes

Upon receiving the product, please immediately inspect for any transportation damage, missing parts, or manufacturing defects.



Cleaning and Maintenance

1. For daily cleaning of the bathtub door, you can use common liquid detergent and a soft cloth.
2. For stains, use a clean soft towel or a small amount of neutral soap solution or toothpaste to gently wipe.
3. To keep the glass surface shiny, you can use a polishing agent for polishing treatment.

Precautions

1. Do not use acidic, alkaline, or sharp tools during cleaning to avoid damaging the glossiness of shower trays, glass, metal materials, and other accessories' surfaces.
2. Avoid using strong detergents containing acetone or ammonia ingredients; when disinfecting, avoid using disinfectants containing formic acid and formaldehyde to prevent damage to the product's surface glossiness.
3. Do not allow body or hard objects to come into contact with or impact the glass surface during showering to avoid accidents.
4. Regularly check the usage condition of the bathtub door, and if any abnormalities are found, please contact the after-sales service department promptly.

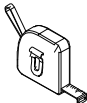
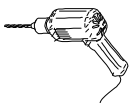
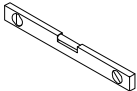
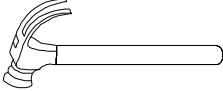
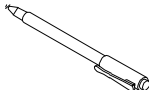
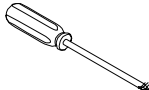
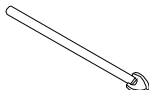
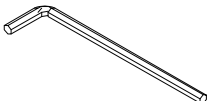
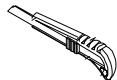
Tool List (Not Included)

Material Name	Illustration	Material Name	Illustration
Tape measure		Electric drill	
Spirit level		Hammer	
Marker pen		Screwdriver	
1/4" drill bit		Allen wrench	
Utility knife		Silicone sealant	

Accessory List

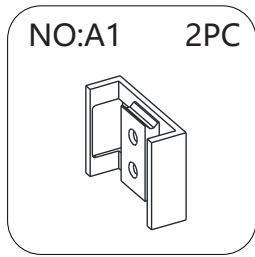

Guide rail
wall sleeve

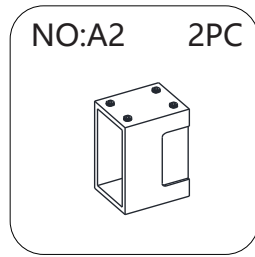

Guide rail
wall sleeve

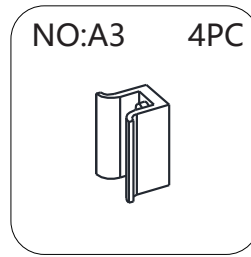

Guide rail
wall sleeve

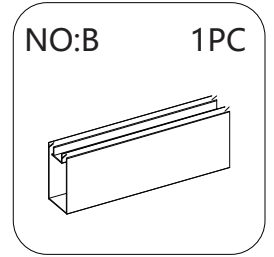

Guide Rail Sleeve

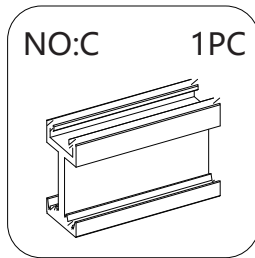

Inner Guide Rail

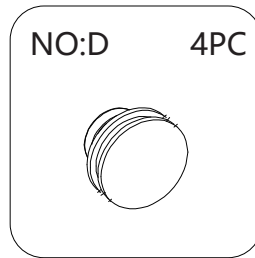

Pulley

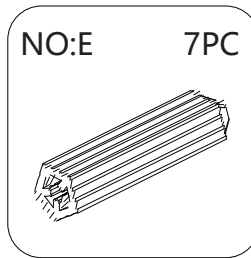

Wall Entry Plug

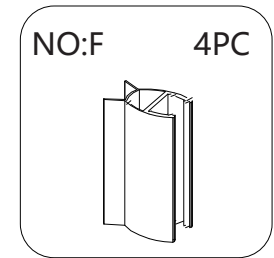

Collision
Prevention Strip

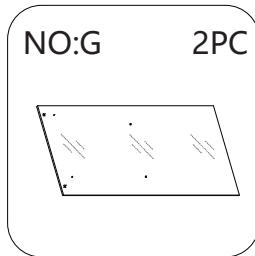

Door Glass

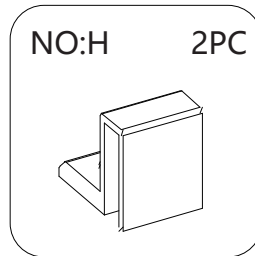

Lower Water Stop Bar
Fixing Parts

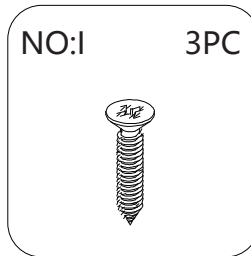

Screw-A

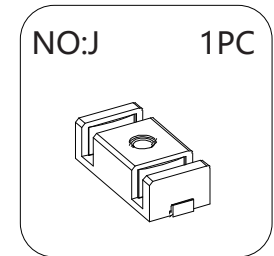

Lower Slider

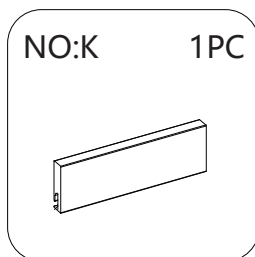

Lower Water Stop Bar

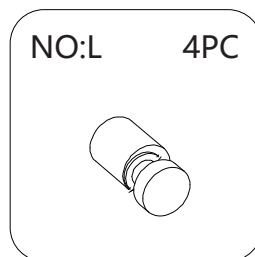

Pulley Anti-Detachment
Component

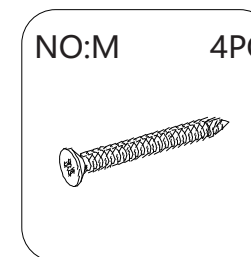

Screw-B

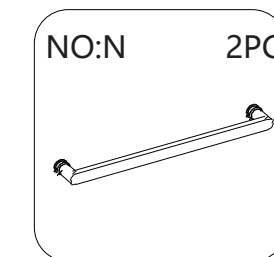

Handle
template

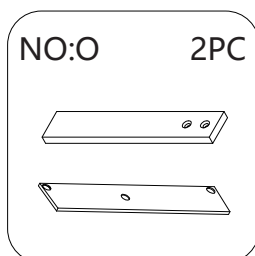

template

Drawings may not exactly define contour of the product.

Installation steps

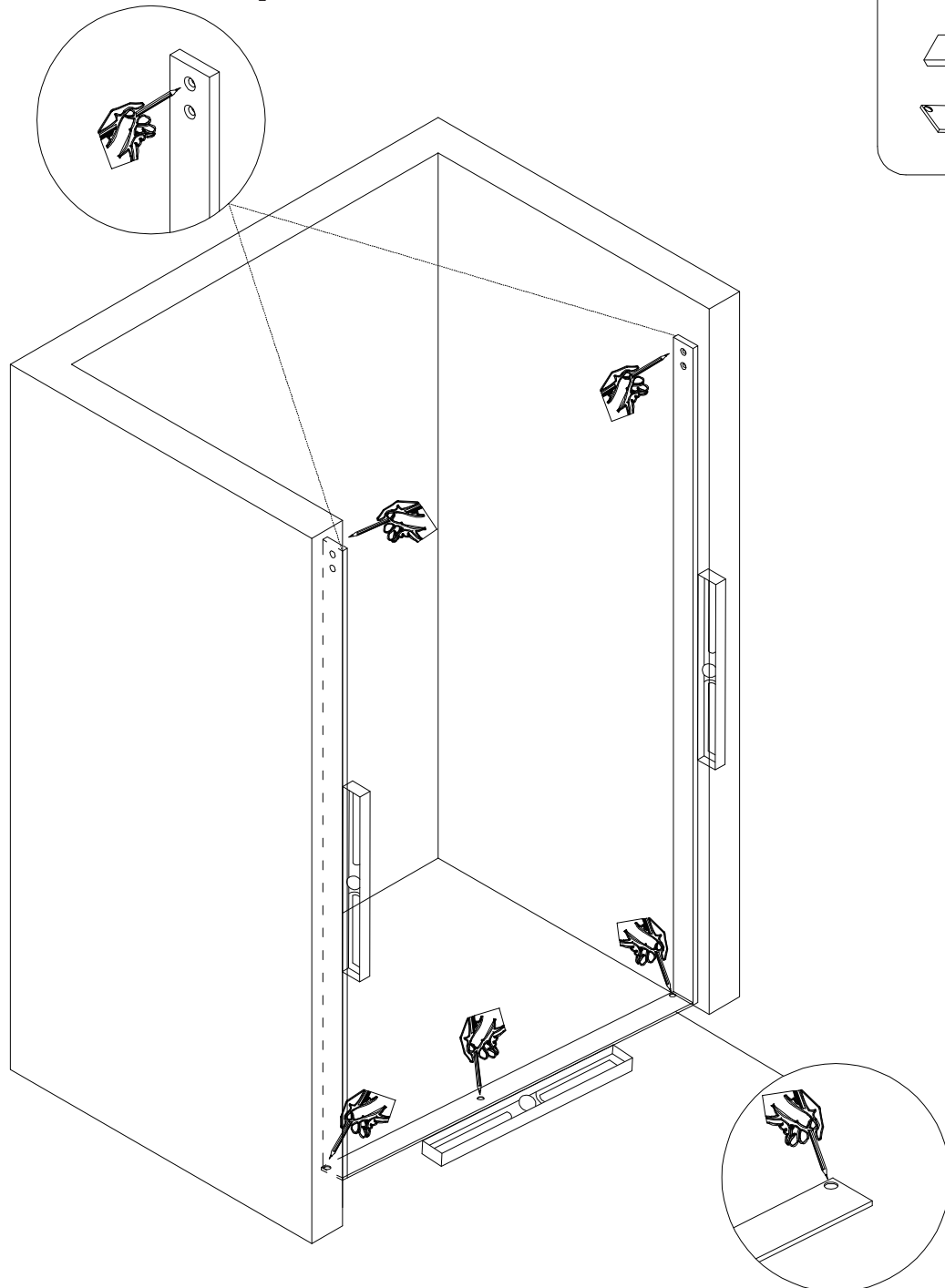

NO:O 2PC

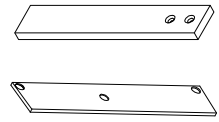

template

Step 1: As shown above, first measure the level of the hole marking template with a level. Then mark each hole with a pencil

Drawings may not exactly define contour of the product.

Installation steps

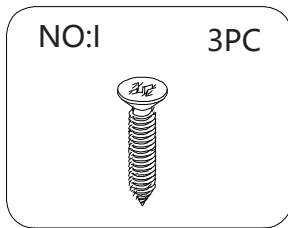

Screw-A

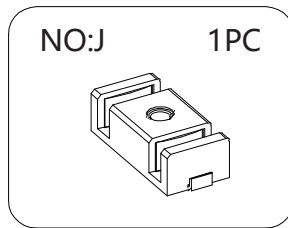

Lower slider

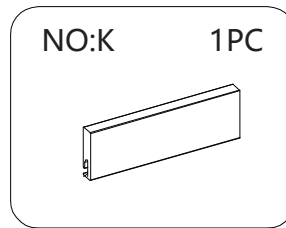

Lower Water Stop Bar

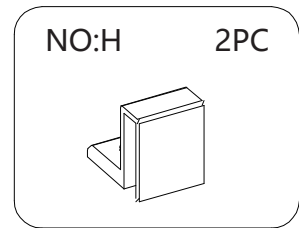

Lower Water Stop Bar
Fixing Parts

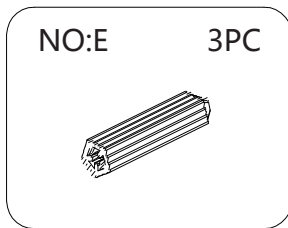

Wall Entry Plug

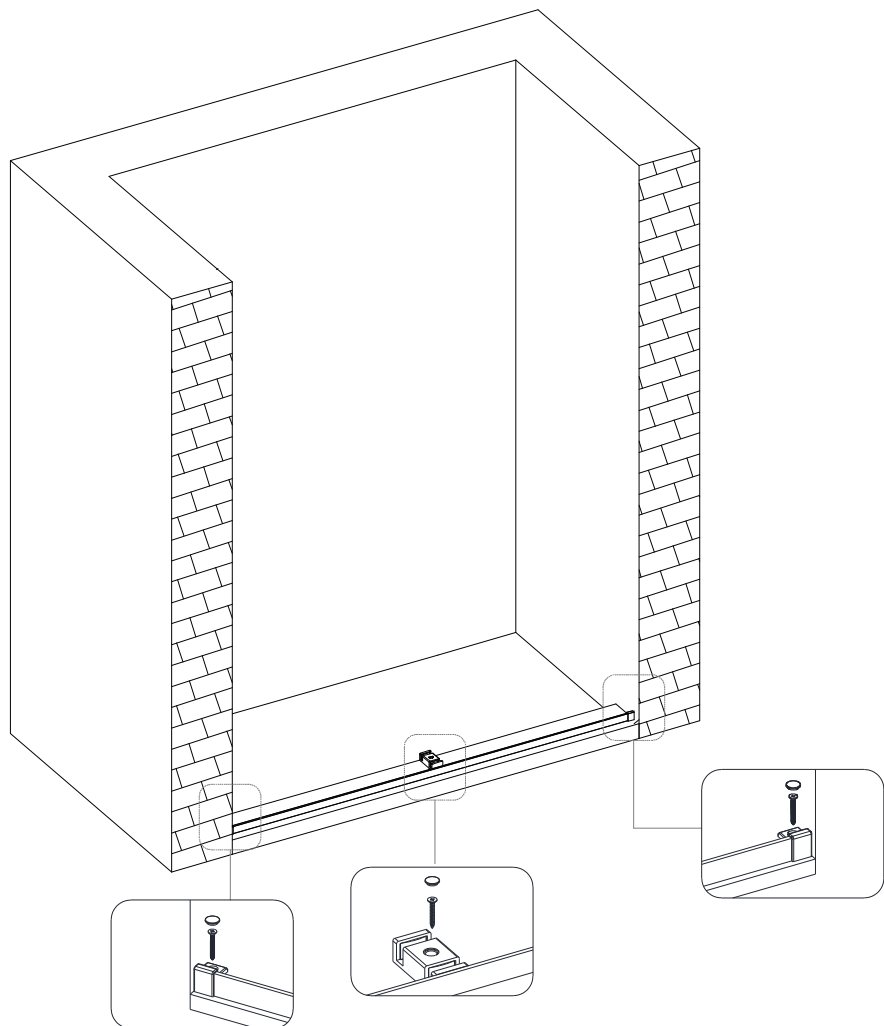
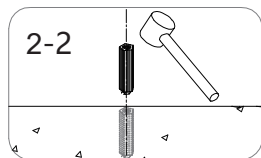
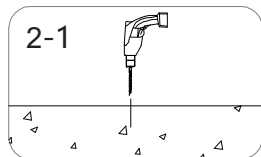

Step 2: Installation of Lower Water Stop Bar

- 2-1. Use a drill bit to create holes for marking points, with a diameter of 1/4".
- 2-2. Insert wall plugs into the holes made on the base/floor surface, ensuring that the end face of the wall plug is flush with the base/floor surface.

Drawings may not exactly define contour of the product.

Special Reminder

Before proceeding to the next step of installation, you need to know the distance of these components from the floor.

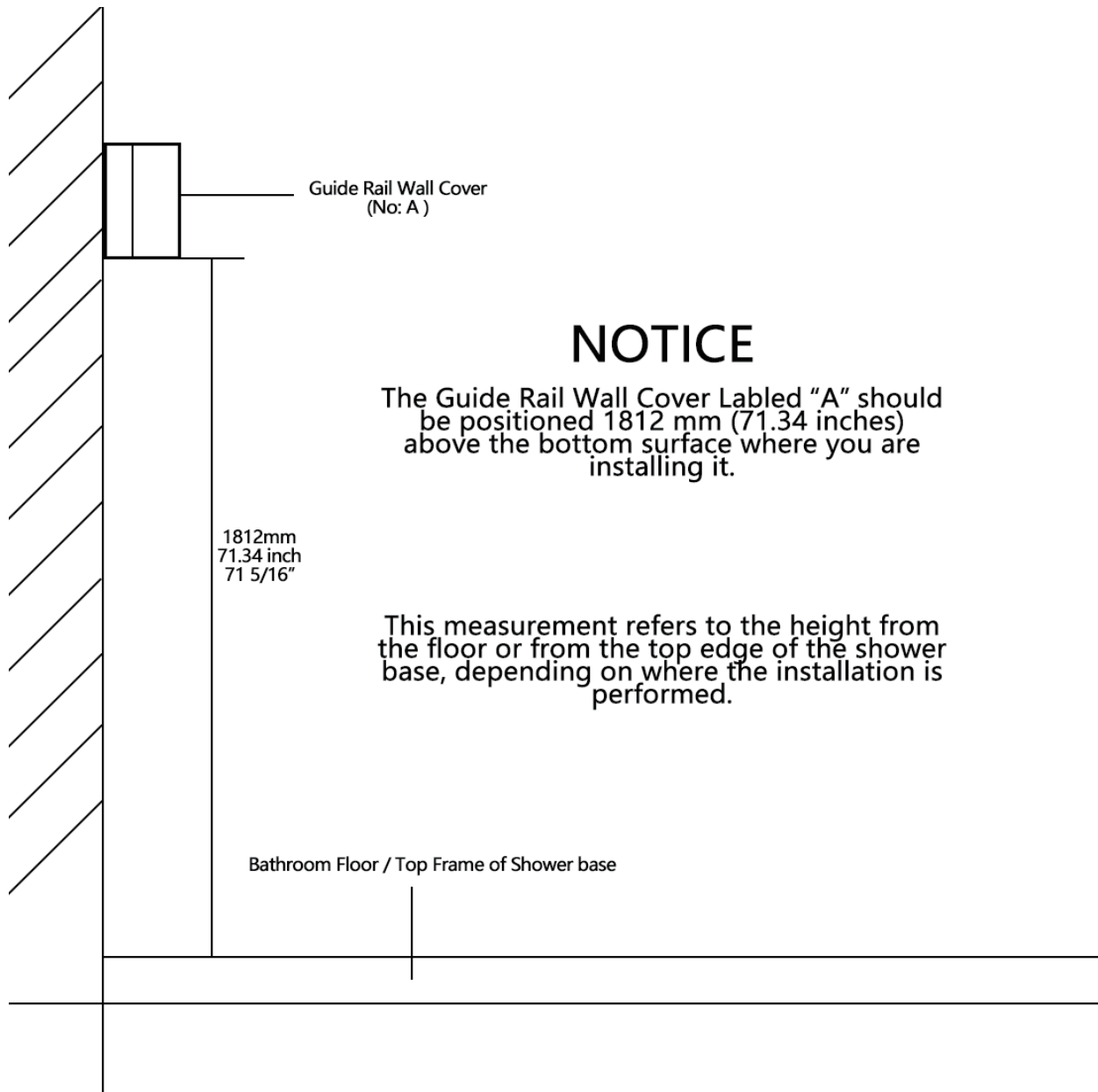

Installation steps

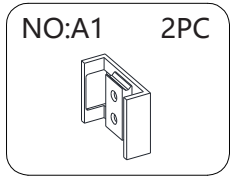

Guide rail wall sleeve

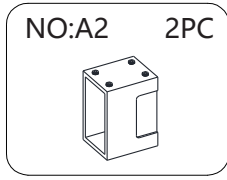

Guide rail wall sleeve

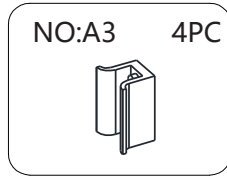

Guide rail wall sleeve

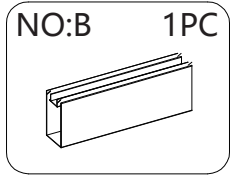

Guide rail cover

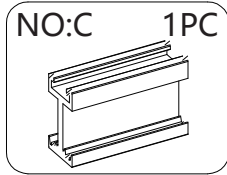

Inner guide rail

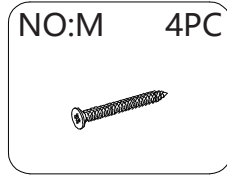

Screw-B

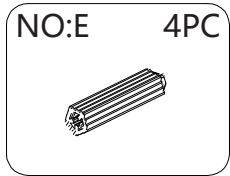

Wall plug

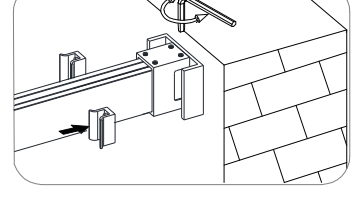
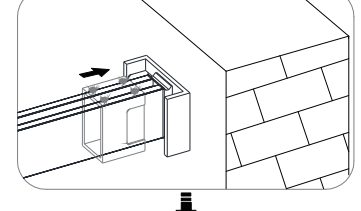
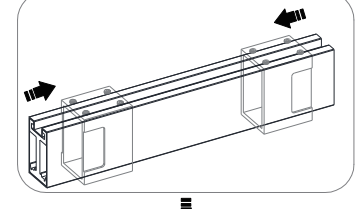
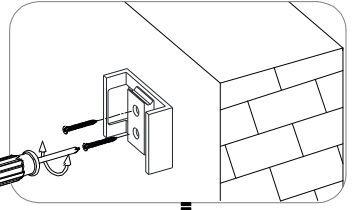
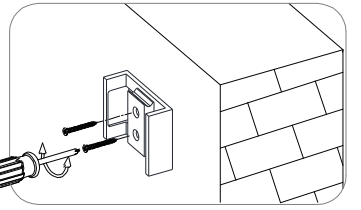
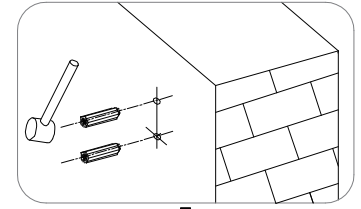
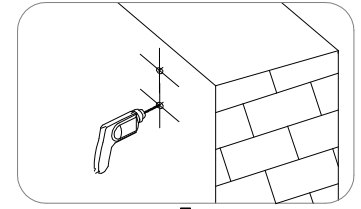
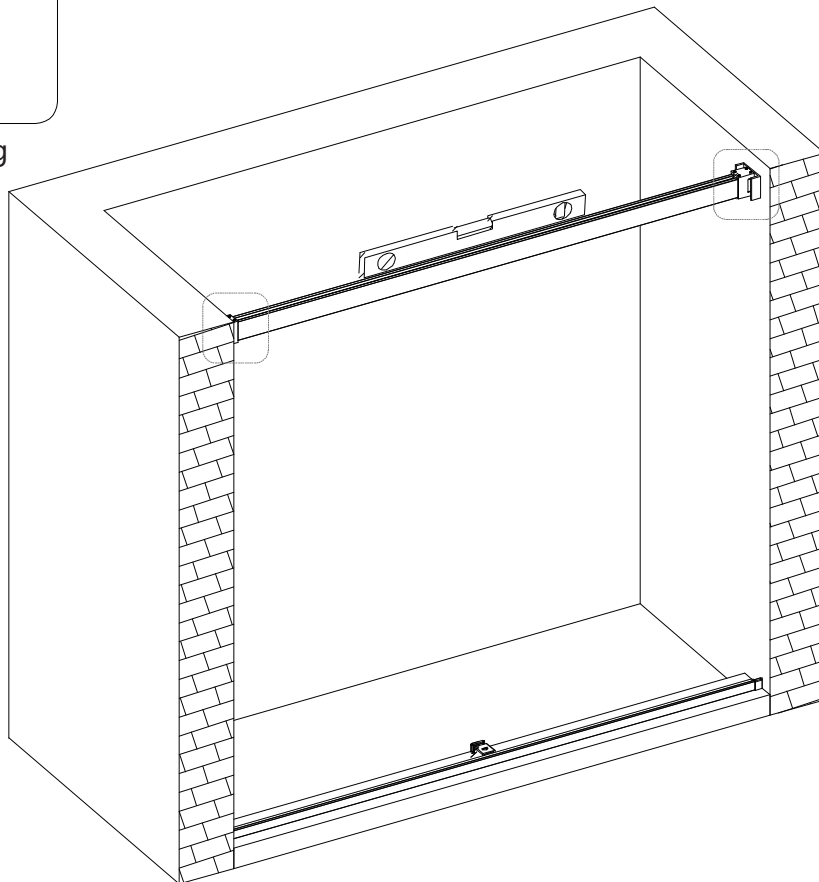

Step 3: Installation Sequence of Upper Guide Rail

(Note: Ensure Horizontal Alignment)

Drawings may not exactly define contour of the product.

Installation steps

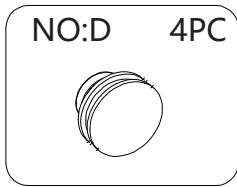

Pulley

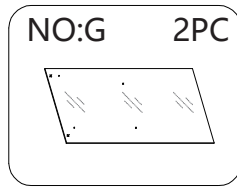

Door Glass

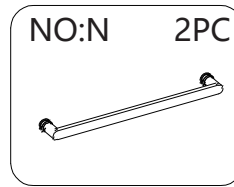

Handle

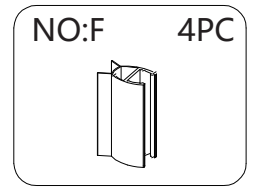

Collision Prevention Strip

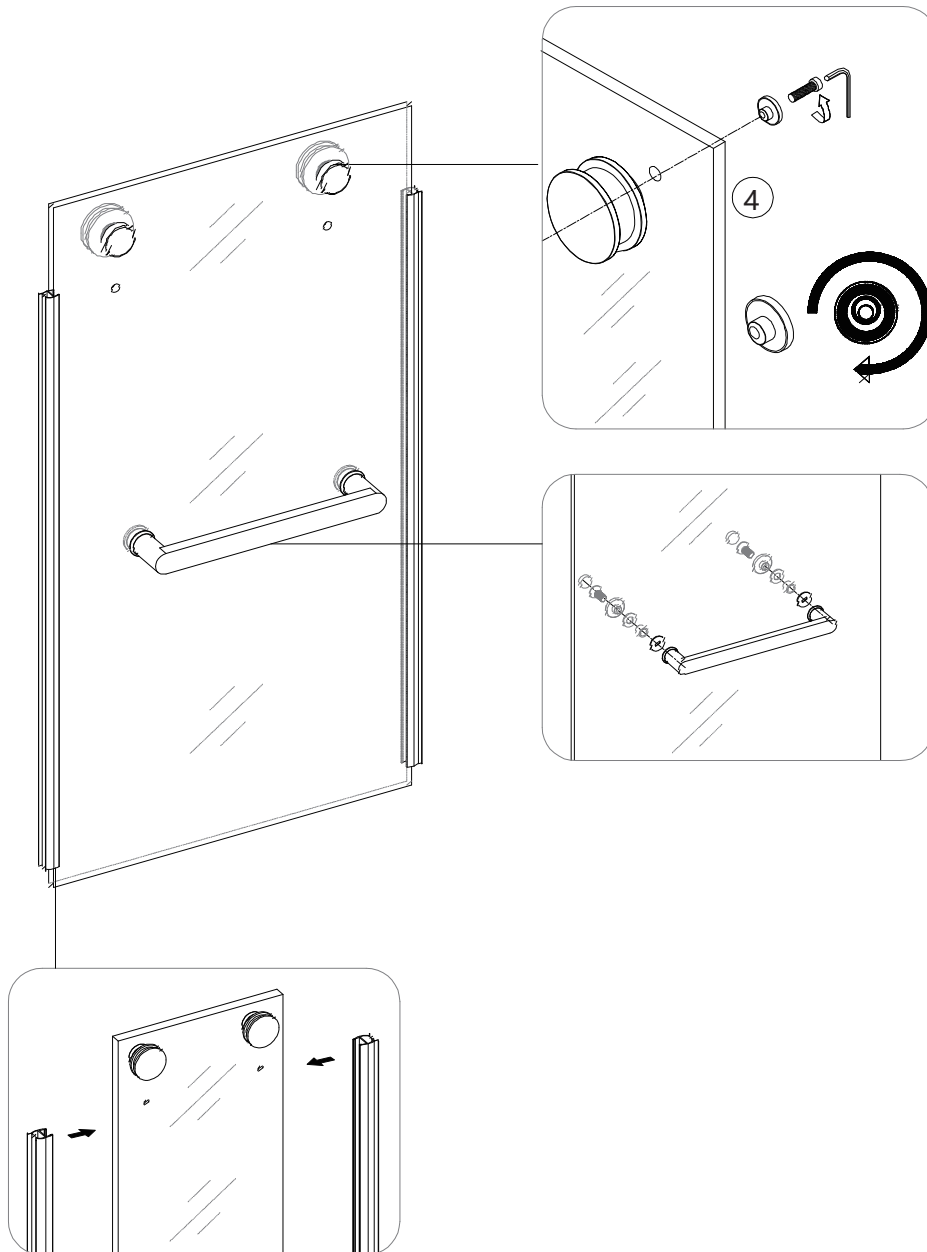

Step 4: Assemble the Door Glass Accessories

Install the pulleys and anti-collision strips.

(The two doors are opposite, please pay attention to assembly.)

Drawings may not exactly define contour of the product.

Installation steps

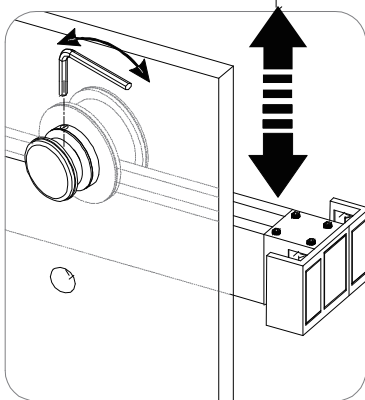
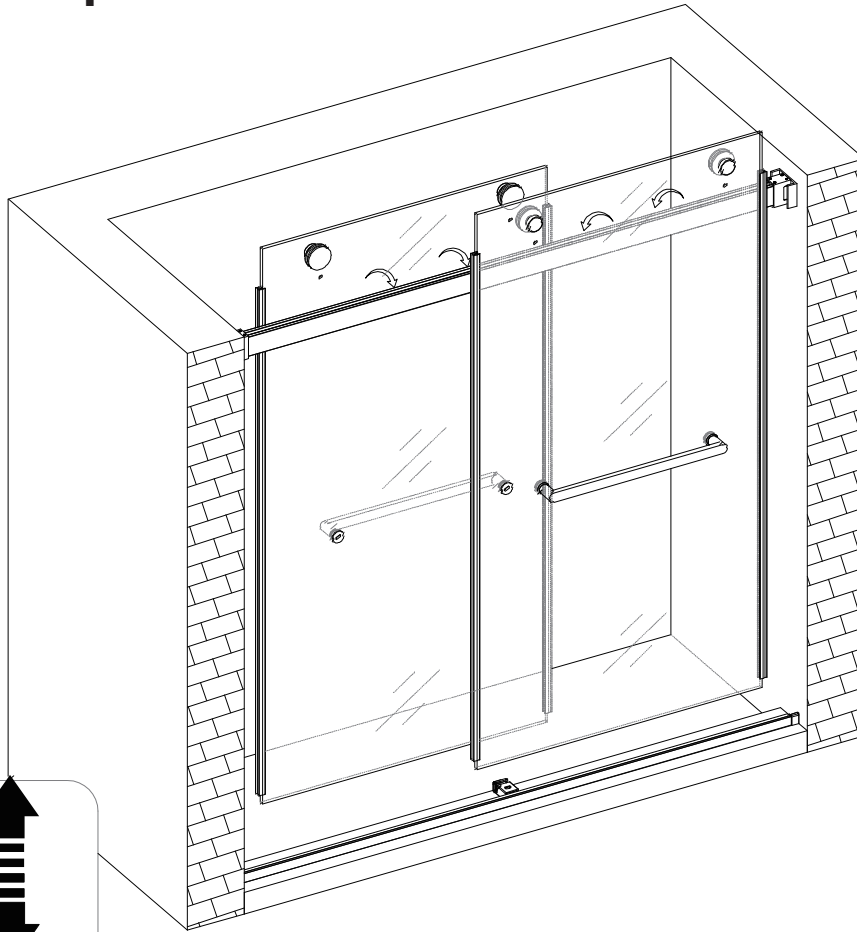

Debugging Guidelines for Door Glass.

Step 5: Hanging the Door Glass / Adjusting Horizontal Alignment
5-1. When hanging door glass, pay attention to the inner and outer door grooves. They are opposite each other, as are the handles. Do not put them in backwards or the door glass will not move.

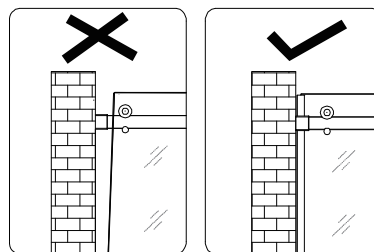

The door glass is considered qualified when it remains stable in an upright position without shaking

Drawings may not exactly define contour of the product.

Installation steps

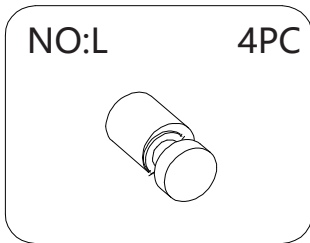

NO:L

4PC

Pulley Anti-Detachment Component

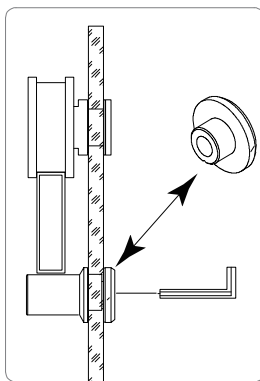
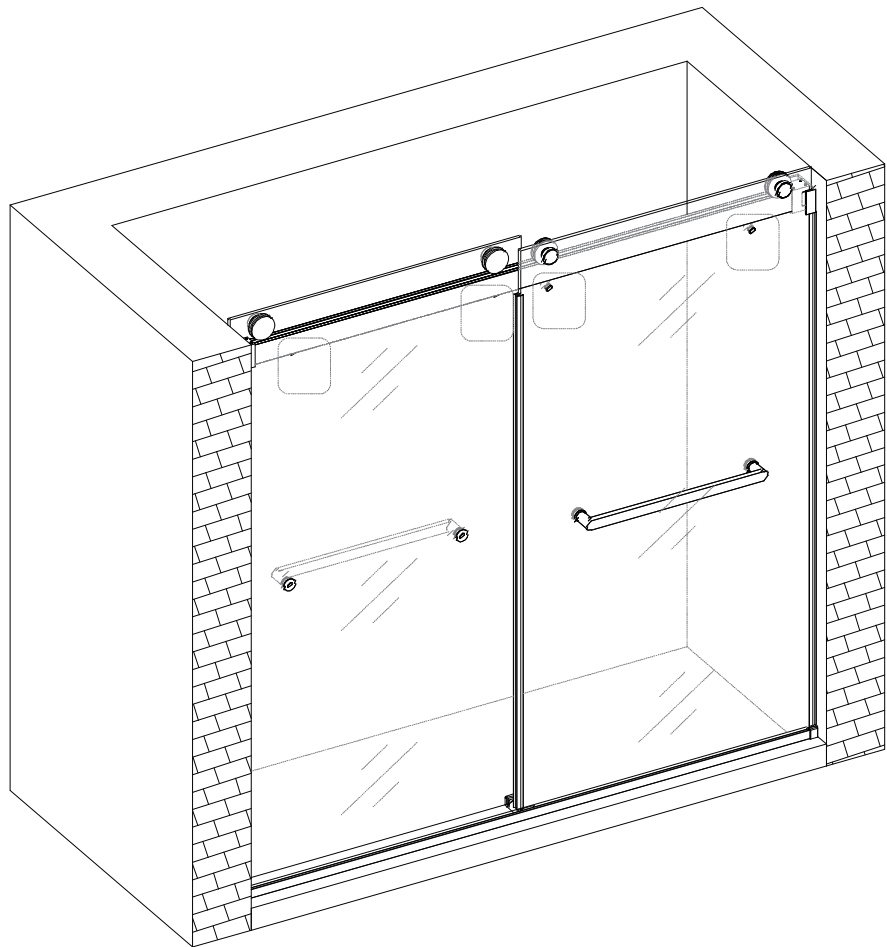

Debugging the anti-detachment positioning component of the door glass.
(The component should be snug against the guide rail.)

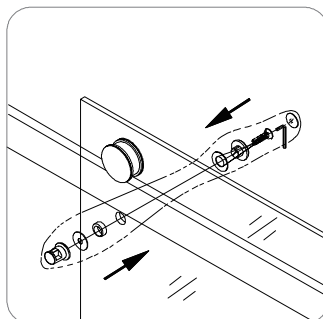

Installing anti-detachment positioning parts for the door glass.

Step 6: Install Anti-Detachment Accessories

Drawings may not exactly define contour of the product.

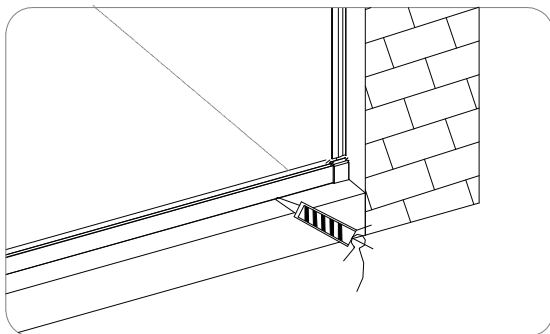
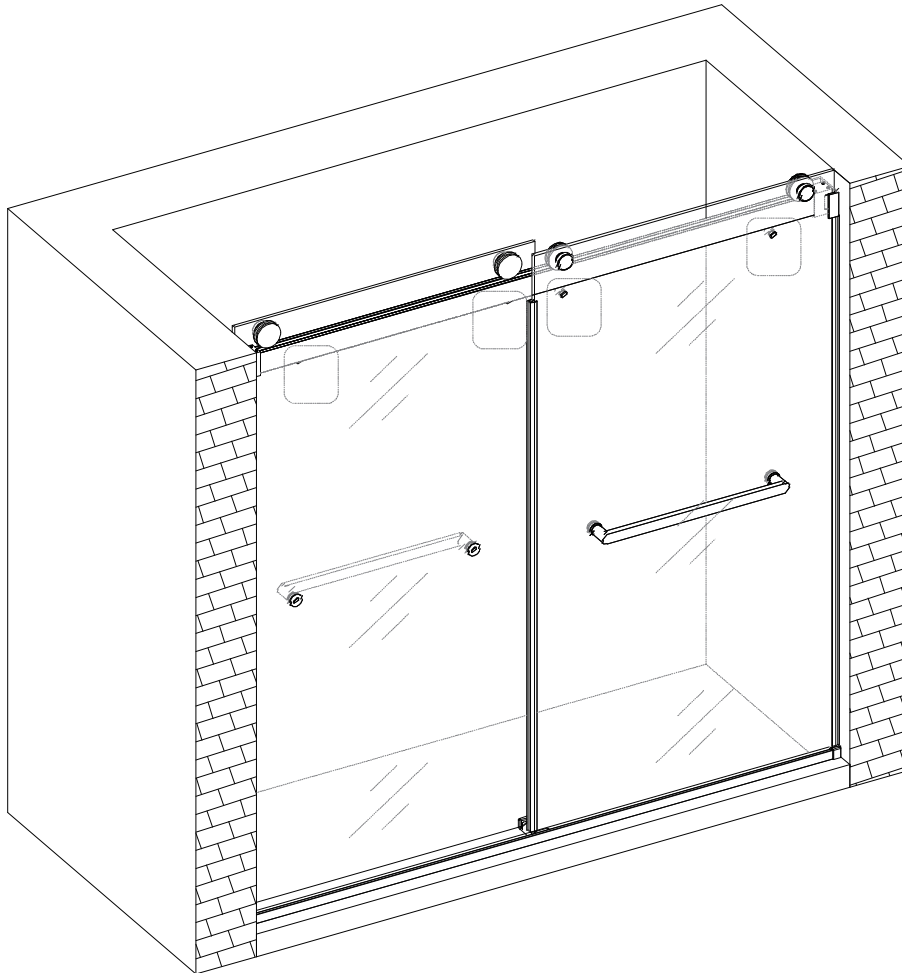
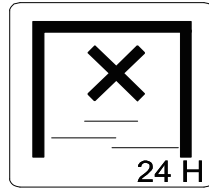
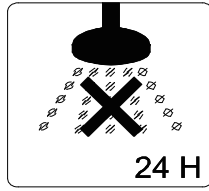
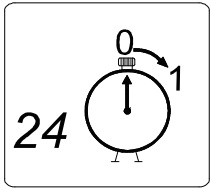

After installation, confirm that there are no abnormalities, and apply glass glue for waterproofing.

Drawings may not exactly define contour of the product.

LIMITED WARRANTY COVERAGE

5-YEAR LIMITED WARRANTY

DeerValley products are made with quality materials and excellent craftsmanship to provide customers with a long-lasting product. If any defects in materials or craftsmanship are found under normal use within the 5th year of delivery, DeerValley will provide replacement parts at no charge or, at its option, replace any product or part of the product deemed defective under normal installation, use, service, and maintenance. This warranty applies only to the original purchaser. Proof of purchase will be required to process any claims. SCRATCHES ARE NOT COVERED UNDER WARRANTY.

The manufacturer warrants that this product will be free from manufacturing defects for the duration of the above-mentioned warranty period. Please retain a copy of the original invoice as proof of purchase.

DeerValley will, at its option, (1) repair or replace the defective part(s) or product(s) at no charge; (2) issue a refund for the original purchase price of the product(s) (valid within 30 days from the date of delivery); or (3) issue a credit to be applied toward the purchase of a new DeerValley product. Shipping/delivery charges may apply and are at DeerValley's sole discretion.

DeerValley recommends that installations be performed by a licensed, professional plumber. DeerValley will not be held responsible for any damage or product failure resulting from improper installation, misuse, or failure to hire a licensed professional. Additionally, DeerValley is not responsible for any removal or installation costs.

This limited warranty does not cover goods that have been subjected to accidents, negligence, improper installation, product abuse, product misuse, or the use of cleaners containing abrasives, alcohol, or other organic solvents. Such exclusions apply regardless of whether the actions were performed by a contractor, service company, or the purchaser.

DeerValley's responsibility under this limited warranty is limited solely to the replacement of parts and does not cover any other costs. DeerValley will not be responsible for labor charges or any damage incurred during installation, repair, or replacement, nor for any indirect, incidental, or consequential damages, losses, injuries, or costs of any kind related to this product. Except as required by law, this limited warranty replaces and excludes all other warranties, conditions, and guarantees, whether expressed or implied, statutory or otherwise, including but not limited to those regarding merchantability or fitness for a particular purpose.

RESPONSIBILITIES OF OTHERS

It is the responsibility of the installer or building contractor, acting on behalf of the user, to inspect the unit prior to installation. They are responsible for ensuring that the unit is free from defects or damage.

Notices are placed on and within the unit, as well as on the shipping carton, to inform the installer of their responsibility.

If a problem is identified, the unit must not be installed. DeerValley is not responsible for failures or damage that could have been identified, repaired, or prevented through proper inspection and testing prior to installation.

Damage occurring during transit is the responsibility of the carrier. The user or installer must open the crate and inspect the unit for damage upon delivery. If damage is discovered, it must be reported immediately to the seller and the carrier in writing, and an inspection must be requested. If the carrier fails to respond, the issue should be reported to both the seller and the carrier. Freight claims should be filed promptly thereafter.

LIMITATIONS AND EXCLUSIONS

This warranty does not cover negligence, misuse, abuse, improper installation, carelessness, accidents, hard water or mineral deposits, exposure to corrosive materials, misapplication, damages resulting from improper maintenance, alteration of the product, or failure to follow the care or installation instructions provided with your product. The warranty becomes void if the DeerValley product is altered or if repairs are attempted using unauthorized accessories or parts not provided by DeerValley.

DeerValley is not liable for the loss of use of its products, inconvenience, or any other incidental or consequential costs, expenses, or damages. Please note that some states do not allow the exclusion or limitation of incidental damages.

DISCLAIMER

Except as expressly stated, no warranties or obligations, whether express, implied, oral, or statutory, are provided. No dealer or other individual has the authority to make any warranties or representations regarding DeerValley or its products. DeerValley shall not be held responsible for any such unauthorized warranties or representations.

WARRANTY SERVICE

NOTE: When requesting warranty service, please ensure you have the following:

- A copy of the original invoice
- Date of installation
- Description and pictures of the defect
- Model number or product description

To obtain warranty service or replacement parts, contact DeerValley Customer Service. DeerValley will determine whether to repair or replace the product, issue a refund, or provide a credit.