

# Assembly Instructions

Caution : You must read this before you proceed

## Care & Maintenance

- Ø  • Not for commercial use. For residential use only.
- P  • Furniture may scratch floors. We recommend using furniture pads to protect your floors.
- Ø  • Do not put hot items directly on furniture surface.
- Ø  • Do not clean furniture with harsh cleansers or polish.
- Ø  • Do not place furniture under direct sunlight.
- Ø  • Do not place furniture near heating or cooling vents.
- Ø  • Do not write on furniture without a padded barrier to protect the surface.
- Ø  • Do not place furniture outside . For indoor use only.
- Ø  • Stains may be removed with mild soap solution and damp cloth.
- Ø  • Children should not climb or jump on the furniture.
- P  • Dust and pick-up spills using a clean, non-colored, lint-free cloth.

Please look in carton for hardware packs and legs.



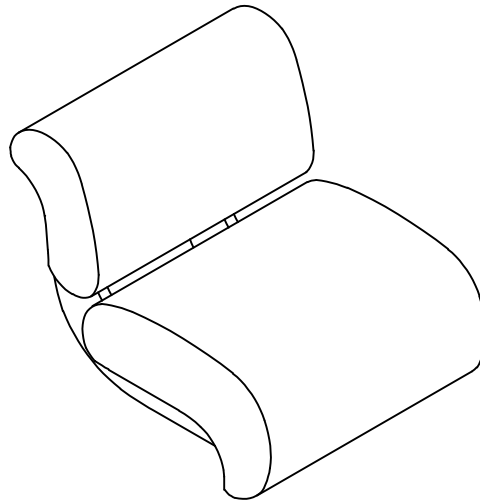

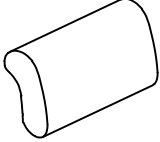
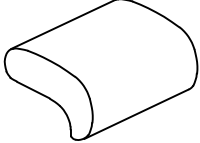
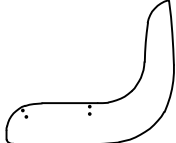
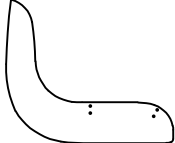
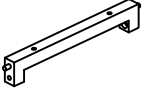

**ACCENT CHAIR  
N767P452335**



**Parts List**

Label	Picture	Description	QTY
A		Backrest	1
B		Seat	1
C		Left Leg	1
D		Right Leg	1
E		Rails	2

## Hardware

Label	Picture	Description	QTY
①		Allen Wrench 4mm	1
②		Bolt Ø1/4" x 40mm	5
③		Spring Washer Ø1/4"	5
④		Flat Washer Ø1/4"	5
⑤		Bolt Ø5/16" x 40mm	9
⑥		Spring Washer Ø5/16"	9
⑦		Flat Washer Ø5/16"	9

## Assembly Preparation

Before  
Bebinning  
Assembly:

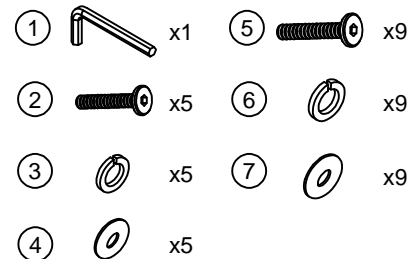
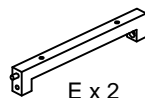
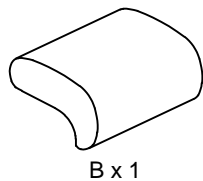
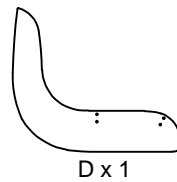
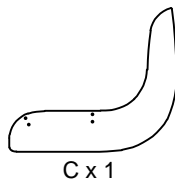
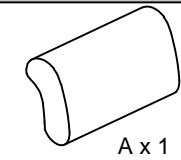

- Read instructions, cover to cover.



- Have 2 adults on hand for assembly.



- Do not assemble on flooring or carpet.



- Assemble on a clean non-marring surface (packing foam).



- Save all packaging until finished.

## Assembly Steps

### Overview

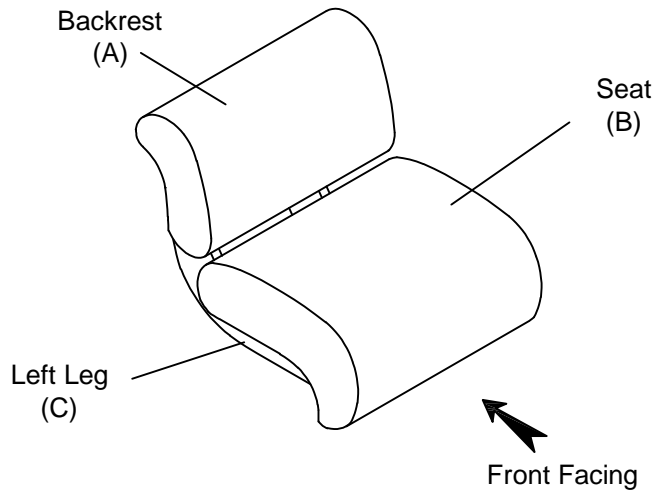

This Accent Chair has multiple parts and may require up to some 30 minutes to assemble. To give you an overview of the Accent Chair parts, the above picture is to help you put the various parts into perspective. Please read through the instructions below to familiarise yourself with the parts and steps before assembly.

### Step 1:

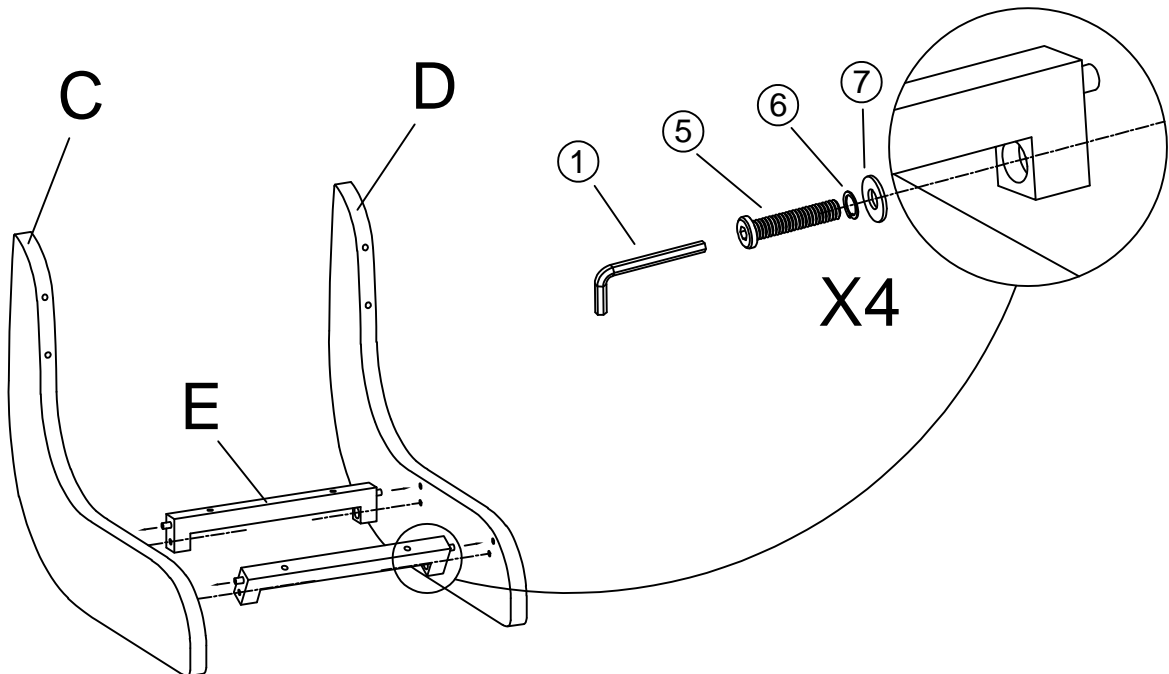

Attach Rails (E) to Left Leg (C) and Right Leg (D) by using Bolt (5), Spring Washer (6), Flat Washer (7) and Allen Wrench (1).

Step 2:

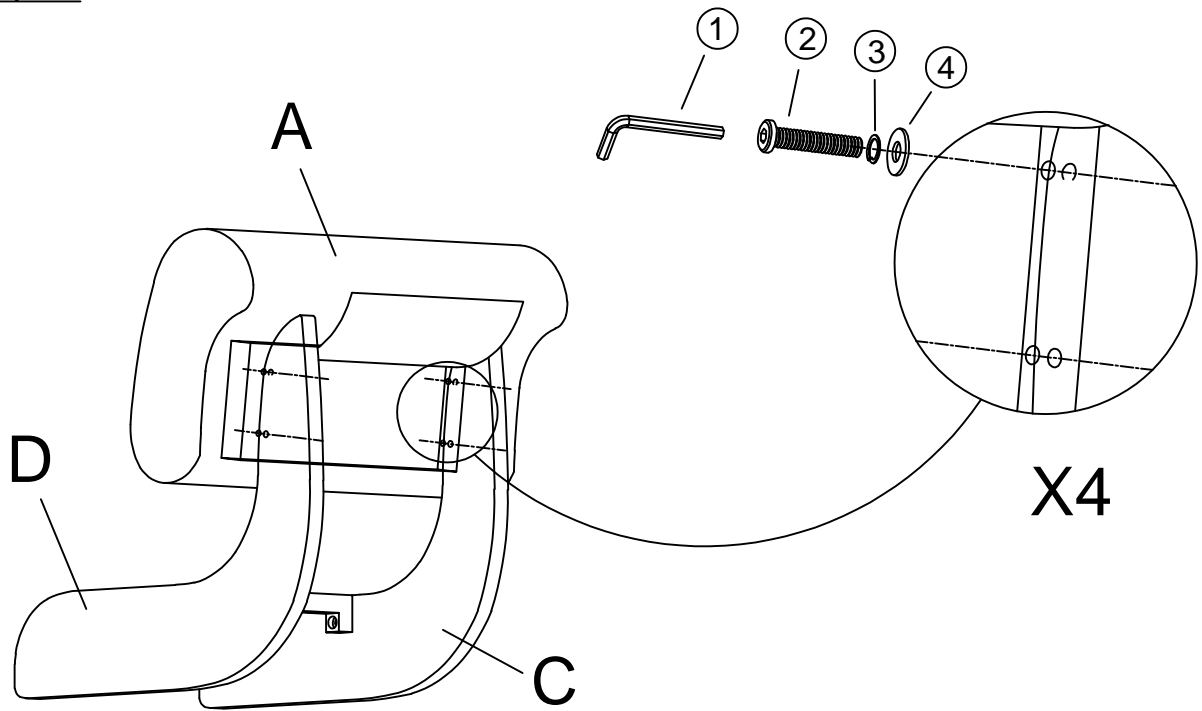

Attach Backrest (A) to Left Leg (C) and Right Leg (D) by using Bolt (2), Spring Washer (3), Flat Washer (4) and Allen Wrench (1).

Step 3:

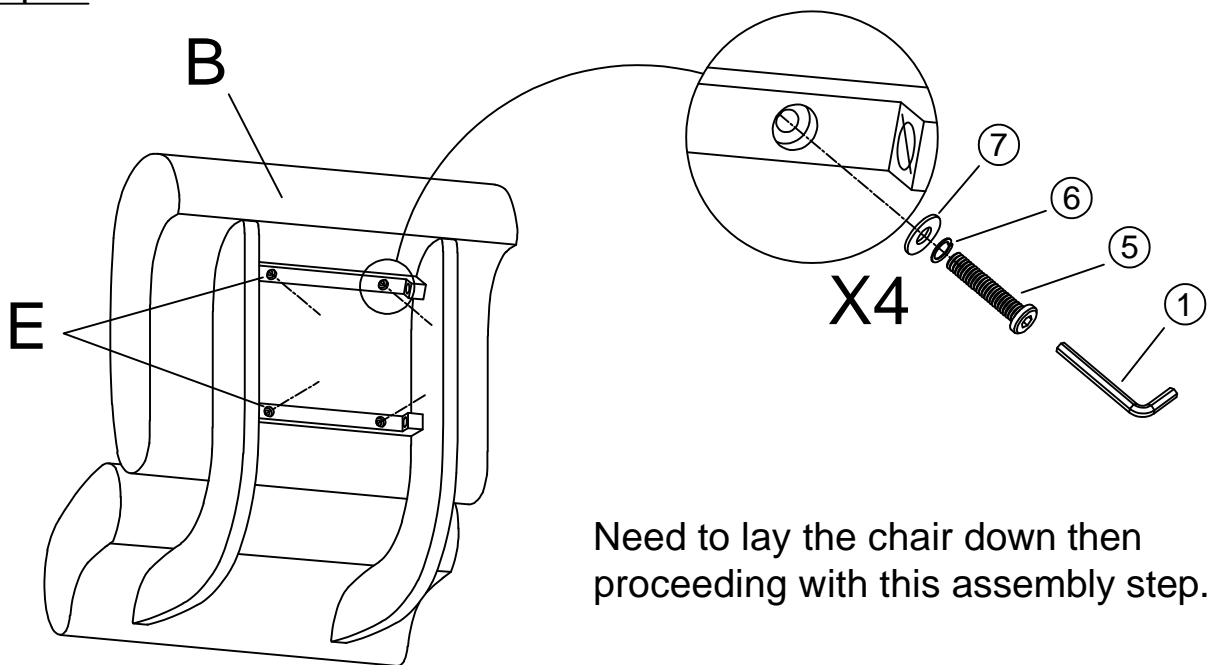

Attach Seat (B) to Rails (E) by using Bolt (5), Spring Washer (6), Flat Washer (7) and Allen Wrench (1).

Step 4

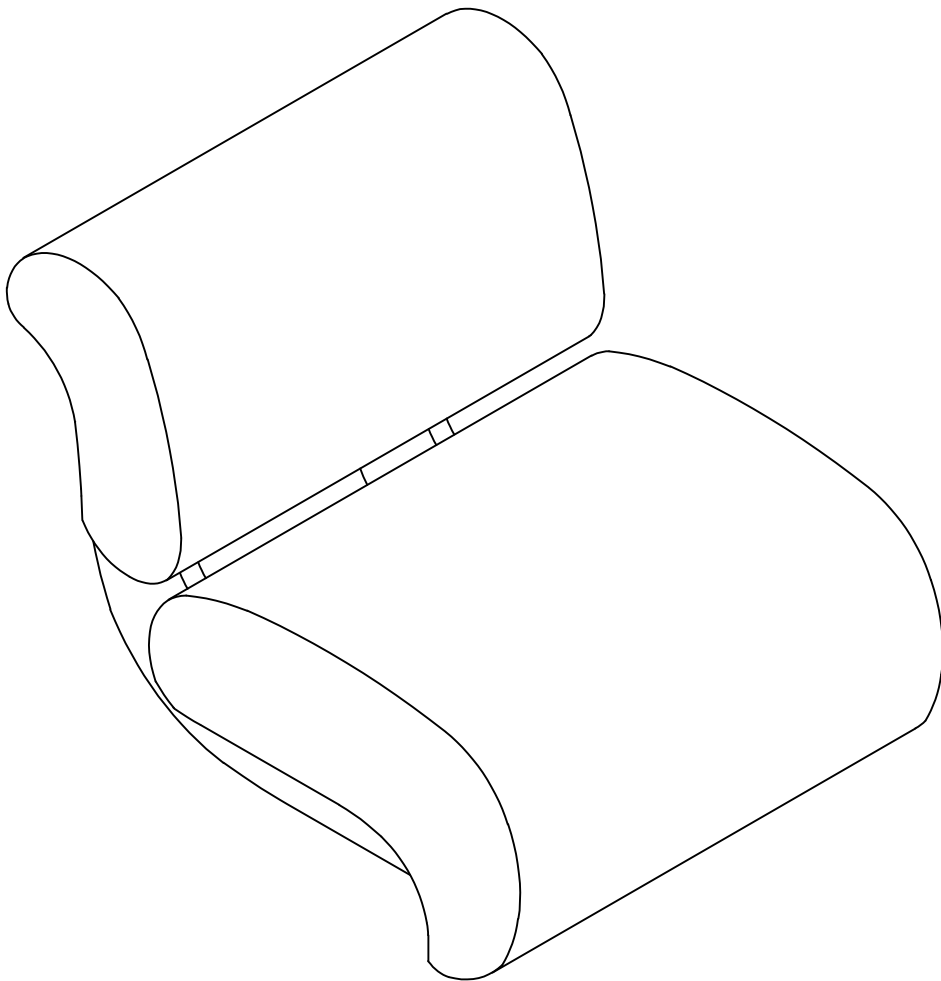

Make sure all parts are connected and locked into position.  
Your Chair is ready for use.  
This Chair can only be used on a flat, level surface.