

OUTDOOR DAYBED

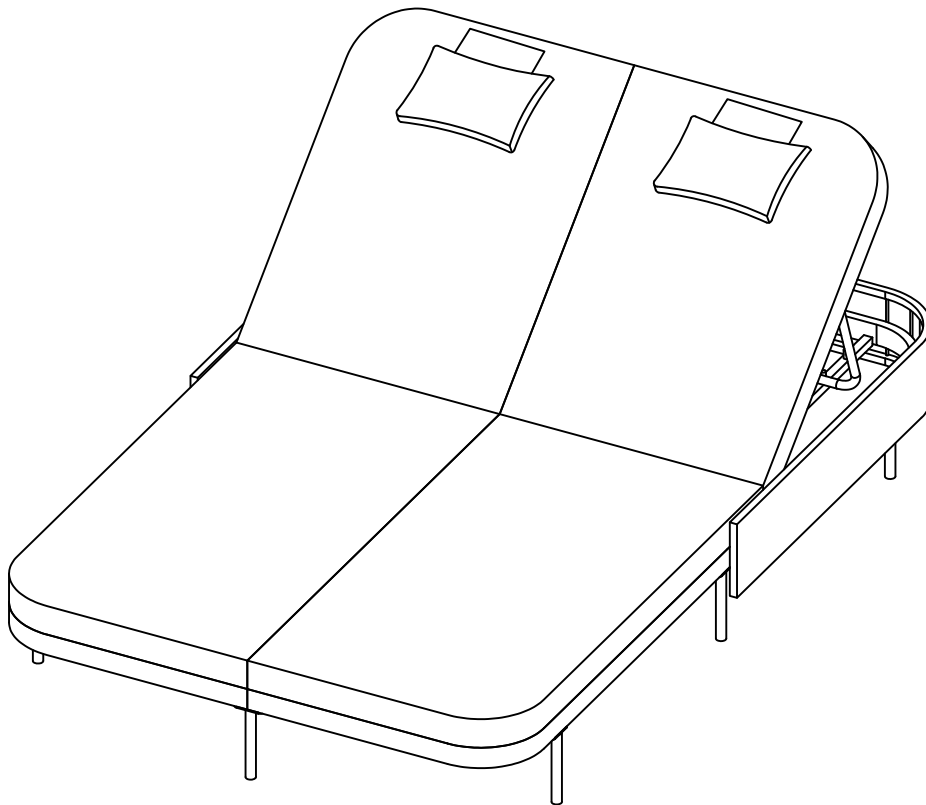

ATTENTION Section:

1. If you encounter any issues, such as missing accessories or damaged parts, please contact us immediately and include pictures

Assembly Instructions:

1. Assembly requires two people to complete.
2. For optimal assembly, we highly recommend using the provided Allen key. If using a power tool, please set it to a low speed to prevent any damage.
3. Do not fully tighten the screws until all screws are properly aligned with their holes.

Back Cushion Notes:

1. The back cushion is vacuum-sealed. After opening the bag, allow some time and fluffing for the cushion to return to its original thickness.
2. Fluff and shake the cushion to help it fully restore its original thickness before use.

Assembly Instruction

Caution: You must read these Assembly Instructions before you proceed.







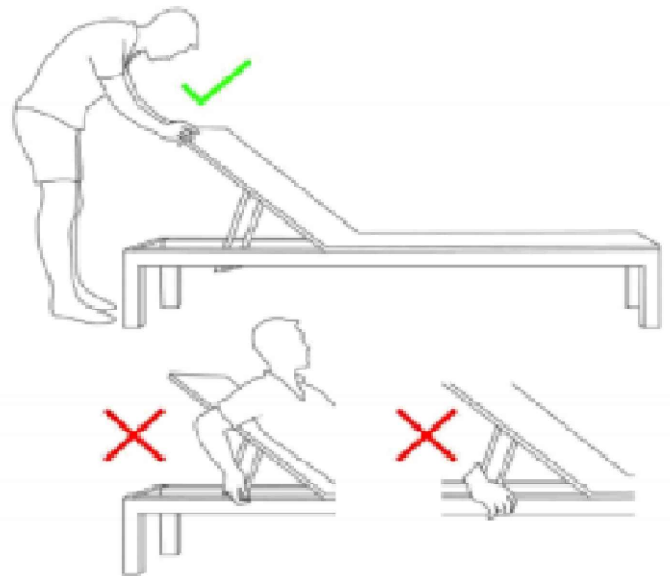















SAFETY WARNING

- Never adjust the chaise lounge or recliner backrest while seated.
- Always make sure the backrest is flat before moving the chaise lounge.
- Keep all limbs clear of under the backrest when it is in a raised position.
- Serious finger, hand, or other bodily injuries may result from adjusting the chaise lounge backrest position while seated.









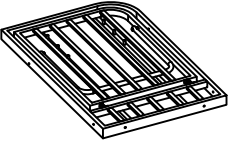
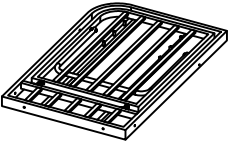

The examples pictured above are non-exhaustive and are for your reference only.

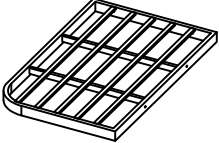
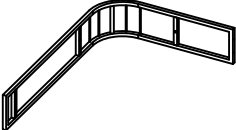
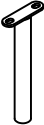
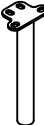
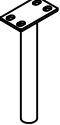
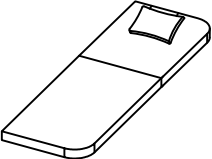
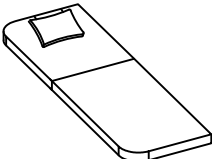
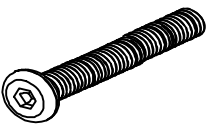
Care & Maintenance

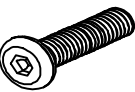
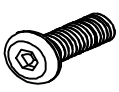
-   - Not for commercial use. For residential use only.
-   - Do not put hot items directly on furniture surface.
-   - Do not clean furniture with harsh cleansers or polish.
-   - To obtain the longest lifespan of your outdoor products, minimizing exposure to direct sunlight is recommended.
-   - Prolonged exposure to rain may cause rusting which can stain floors.
-   - Children should not climb or jump on the furniture.
-   - Do not write on furniture without a padded barrier to protect the surface.
-   - To obtain the longest lifespan of your outdoor products, avoid extended exposure to rain, snow, and direct sunshine. Whenever possible, cover the product and/or place it under a patio or awning.
-   - Stains may be removed with mild soap solution and damp cloth.
-   - Dust and pick up spills using a clean, non-colored, lint-free cloth.

PARTS LIST OF BOX

<p>A1</p>  <p>Top left frame 1pc</p>	<p>A2</p>  <p>Top right frame 1pc</p>	<p>B1</p>  <p>Bottom left frame 1pc</p>	<p>B2</p>  <p>Bottom right frame 1pc</p>
<p>C</p>  <p>Decorative cover 2pc</p>	<p>D</p>  <p>Chair legs 4pc</p>	<p>G</p>  <p>Chair legs 4pc</p>	<p>H</p>  <p>Chair legs 1pc</p>
<p>F1</p>  <p>Left mattress 1pc</p>	<p>F2</p>  <p>Right mattress 1pc</p>	<p>①</p>  <p>M6*60 2pcs</p>	<p>②</p>  <p>M6*50 8pcs</p>
<p>③</p>  <p>M6*35 6pcs</p>	<p>④</p>  <p>M6*16 28pcs</p>	<p>⑤</p>  <p>M6 54pcs</p>	<p>⑥</p>  <p>M6 10pcs</p>
<p>⑦</p>  <p>1pc</p>	<p>⑧</p>  <p>1pc</p>		

STEP 1

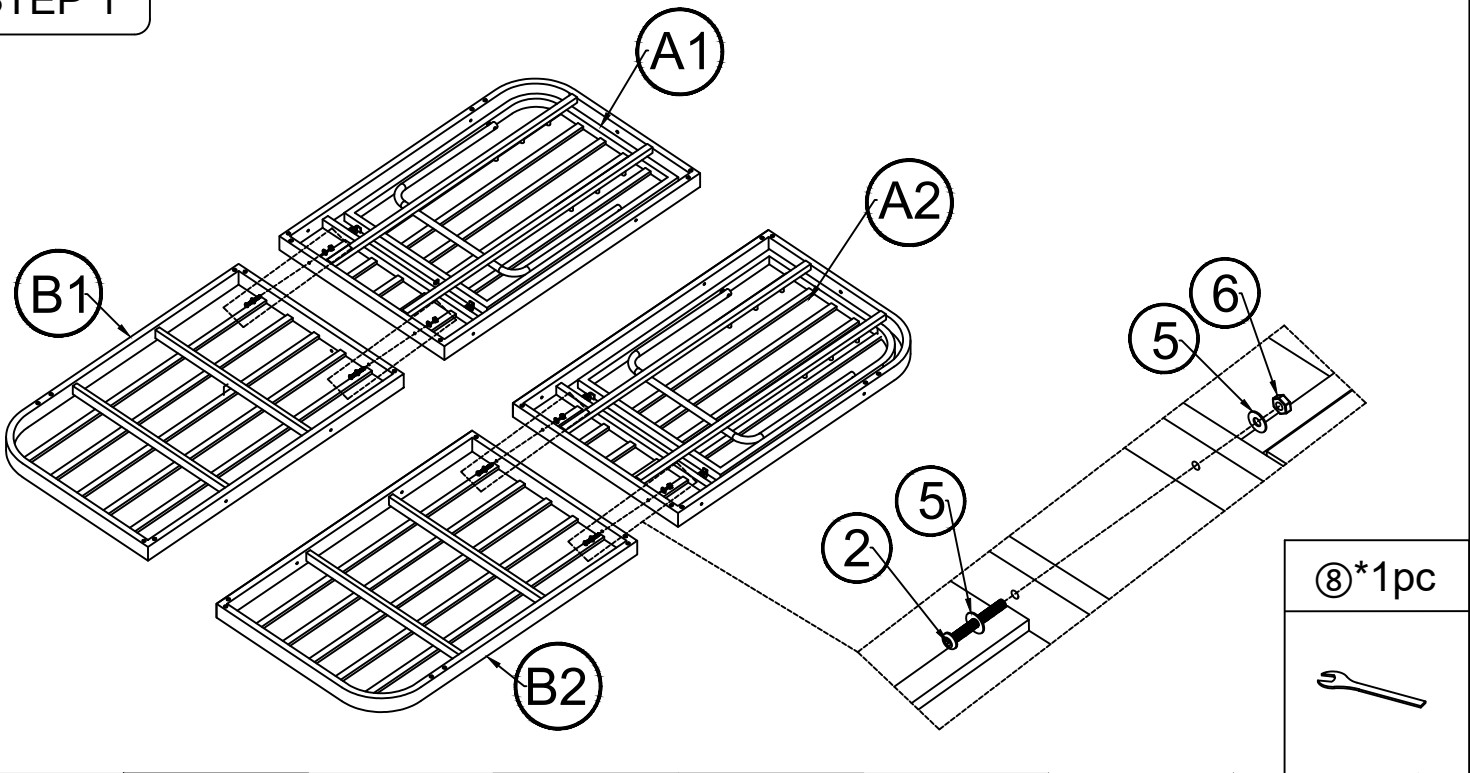

A1*1pc	A2*1pc	B1*1pc	B2*1pc	②*4pcs	⑤*8pcs	⑥*4pcs	⑦*1pc
				 M6*50	 M6	 M6	

STEP 2

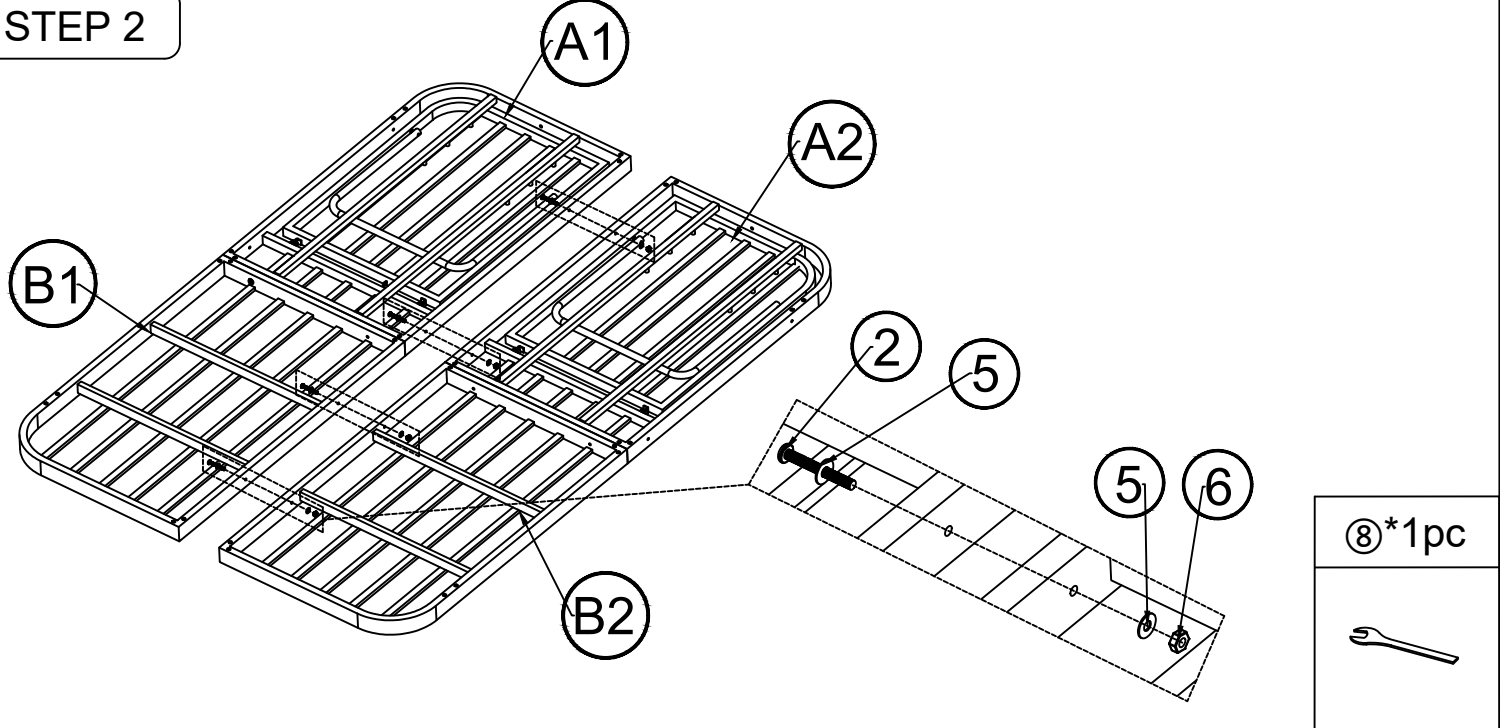

A1*1pc	A2*1pc	B1*1pc	B2*1pc	②*4pcs	⑤*8pcs	⑥*4pcs	⑦*1pc
				 M6*50	 M6	 M6	

Do not fully tighten all screws until assembly is completed.

STEP 3

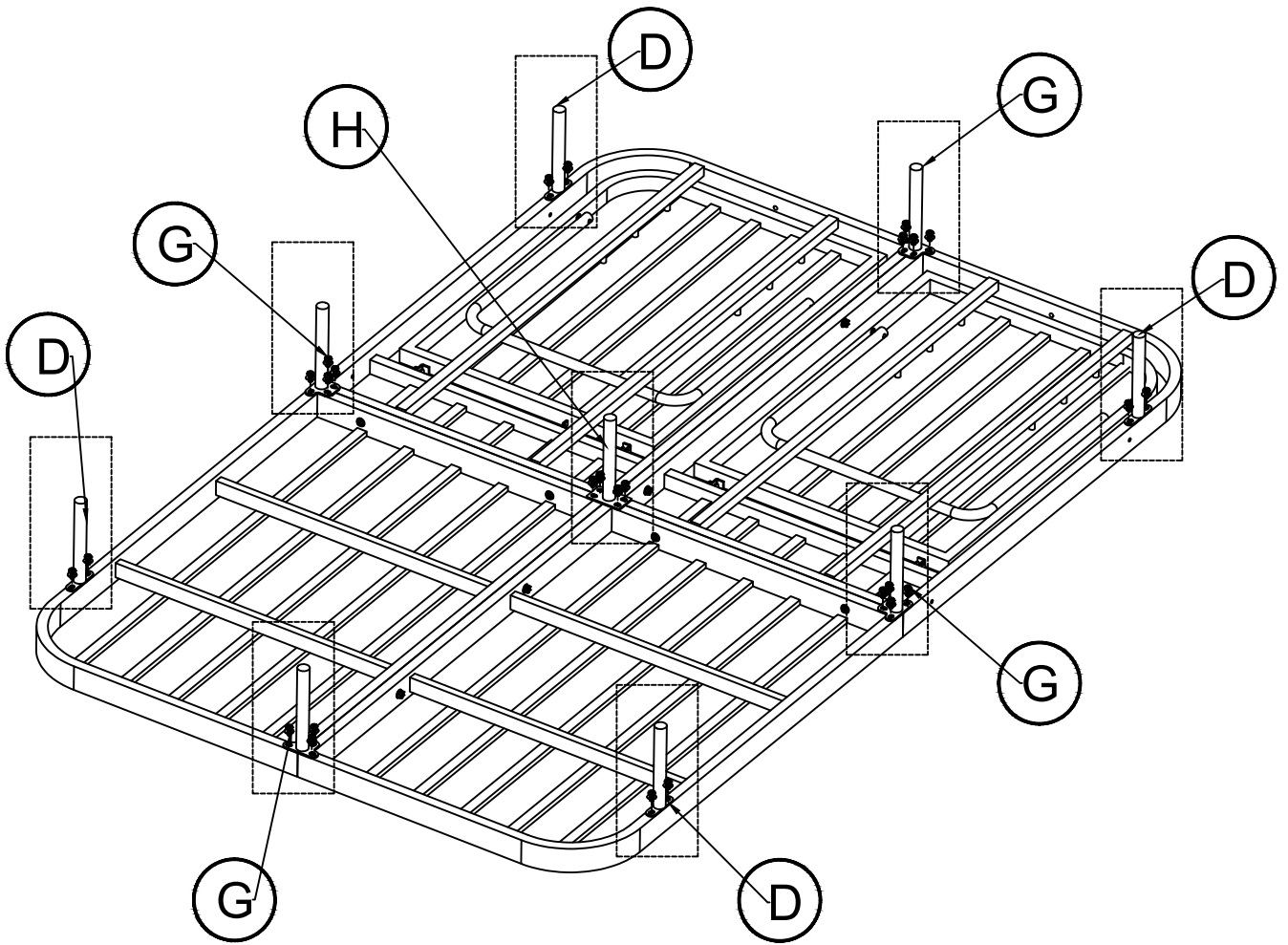

D*4pcs

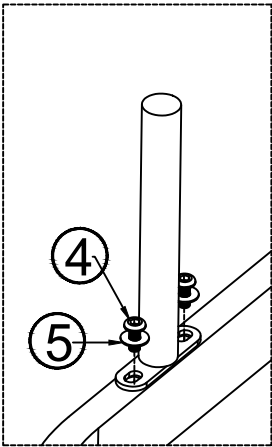

G*4pcs

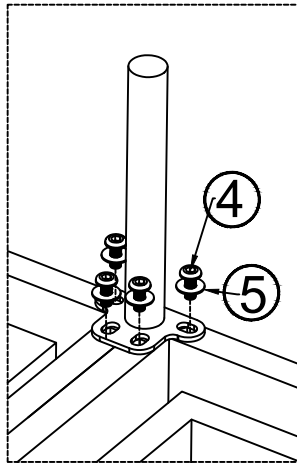

H*1pc

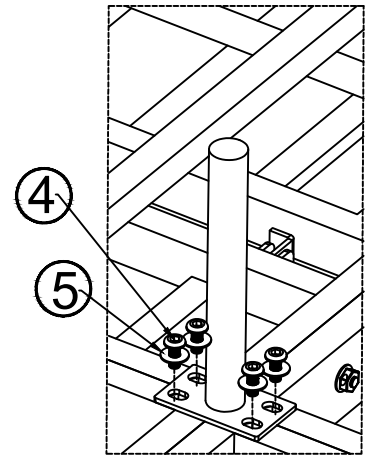

D*4pcs

G*4pcs

H*1pc

④*28pcs

⑤*28pcs

⑦*1pc



M6*16



M6



Do not fully tighten all screws until assembly is completed.

STEP 4

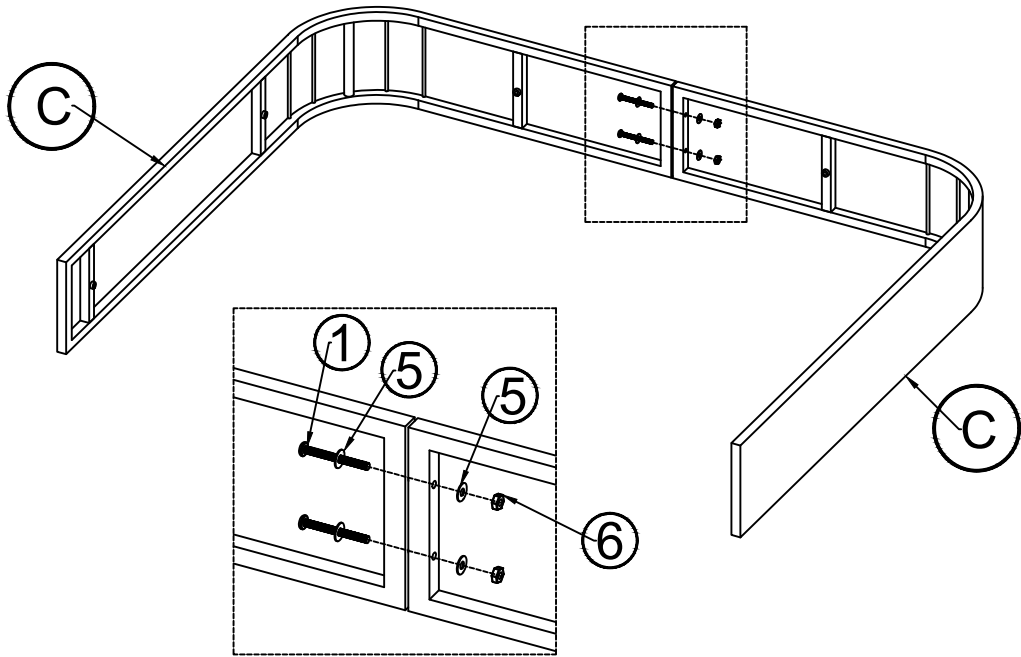

C*2pcs	①*2pcs	⑤*4pcs	⑥*2pcs	⑦*1pc	⑧*1pc
	M6*60	M6	M6		

STEP 5

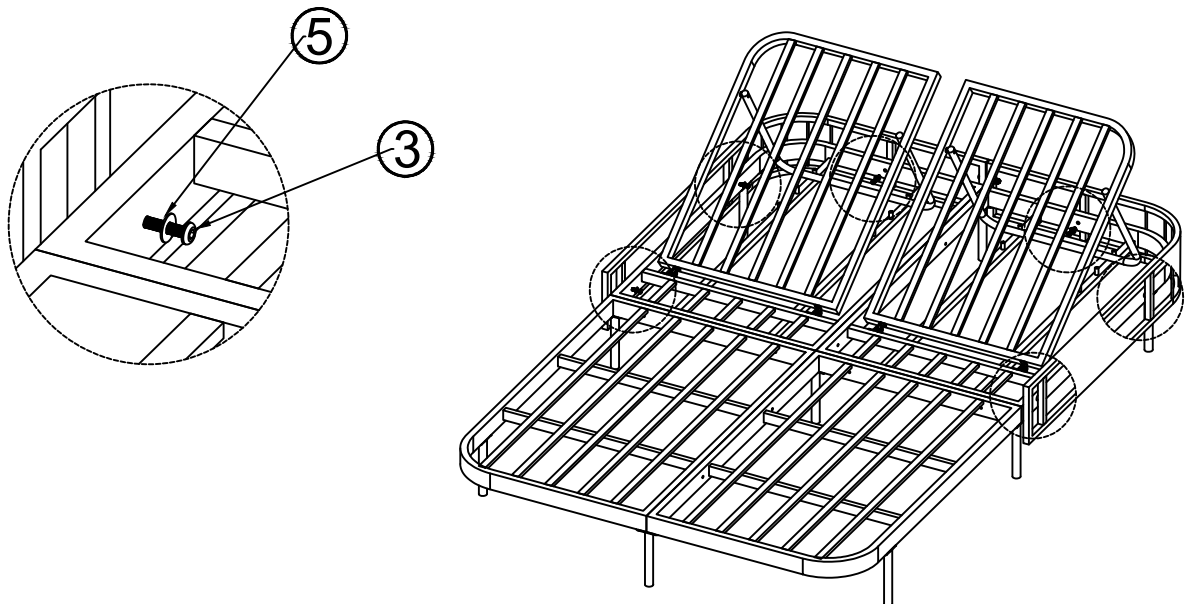

③*6pcs	⑤*6pcs	⑦*1pc
M6*35	M6	

Do not fully tighten all screws until assembly is completed.

STEP 6

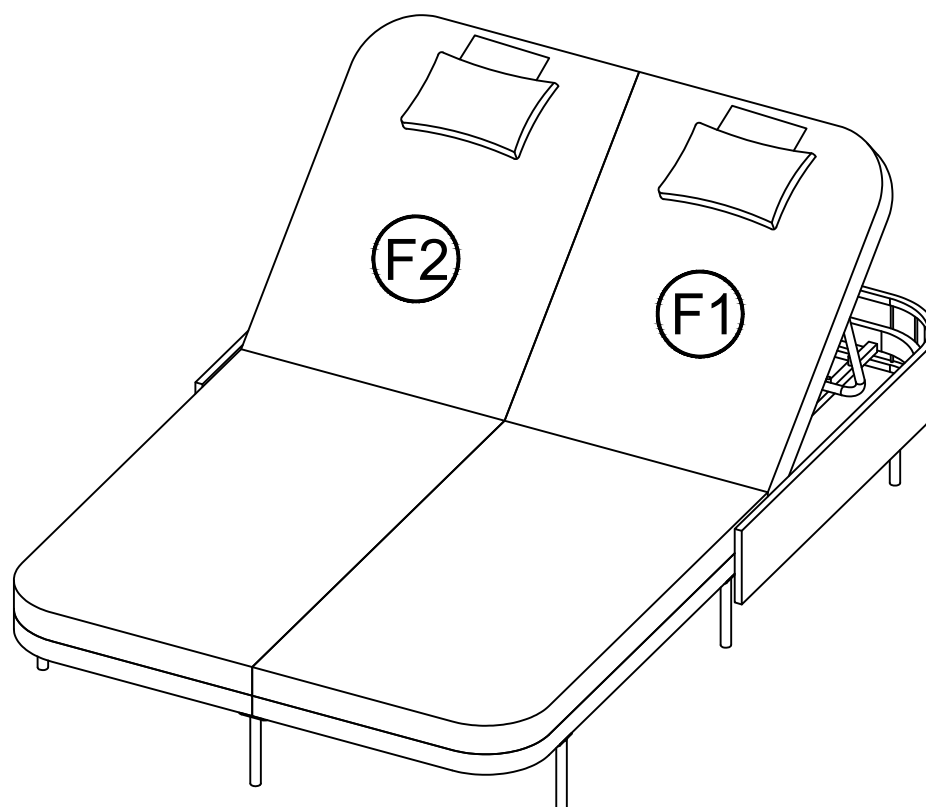

F1*1pc

F2*1pc

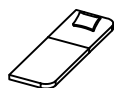

Do not fully tighten all screws until assembly is completed.