

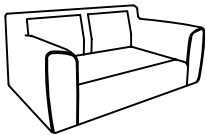



Assembly Instruction

Love Seat (With 2 Pillows)

Note: Do not use power tools for assembly. Power tools increase the risk of over tightening which lead to splitting or cracking the wood.

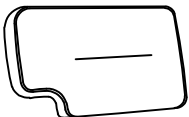
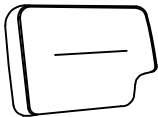
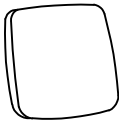
Component list

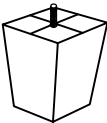
No		Qty	Description
A		1	SEAT
B		2	SEAT CUSHION
C		1	LSF BACK CUSHION
D		1	RSF BACK CUSHION
E		2	PILLOW (18"x18")
F		4	PLASTIC GASKET
G		4	PLASTIC LEGS (100*100*110mm)

Step #1

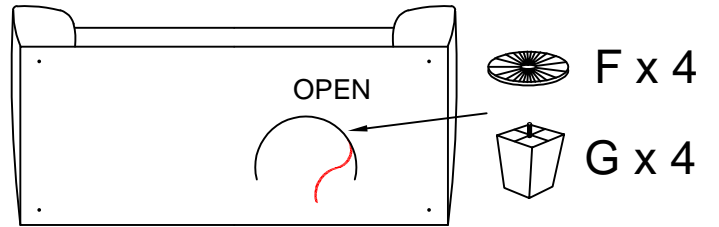
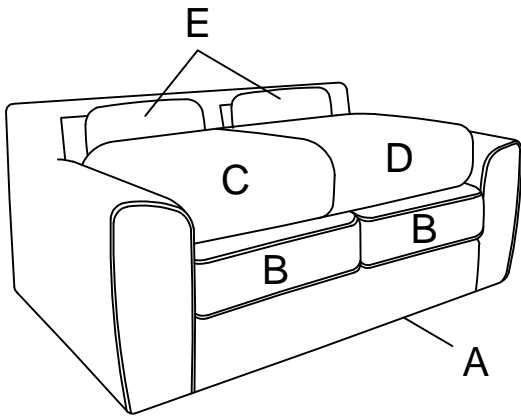

Step #2

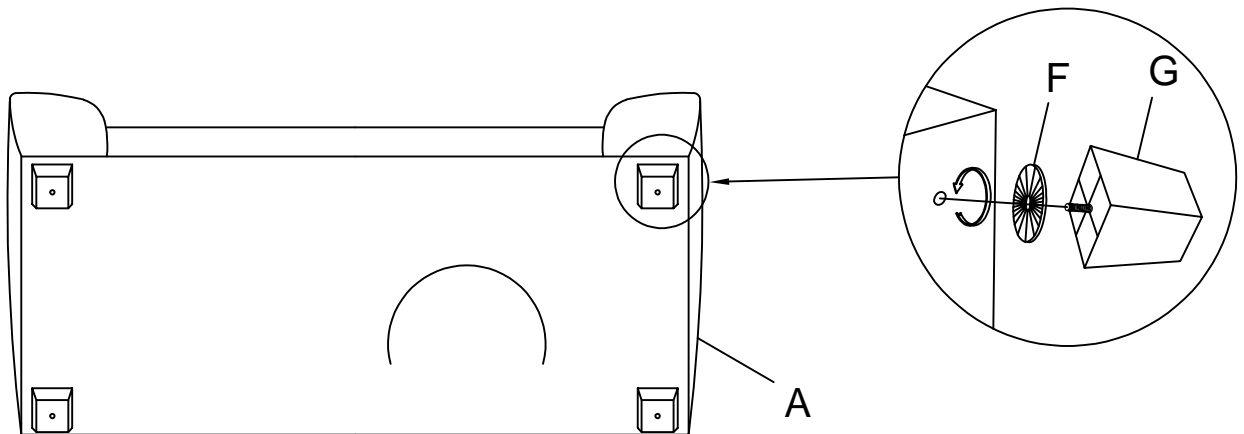

Step #3

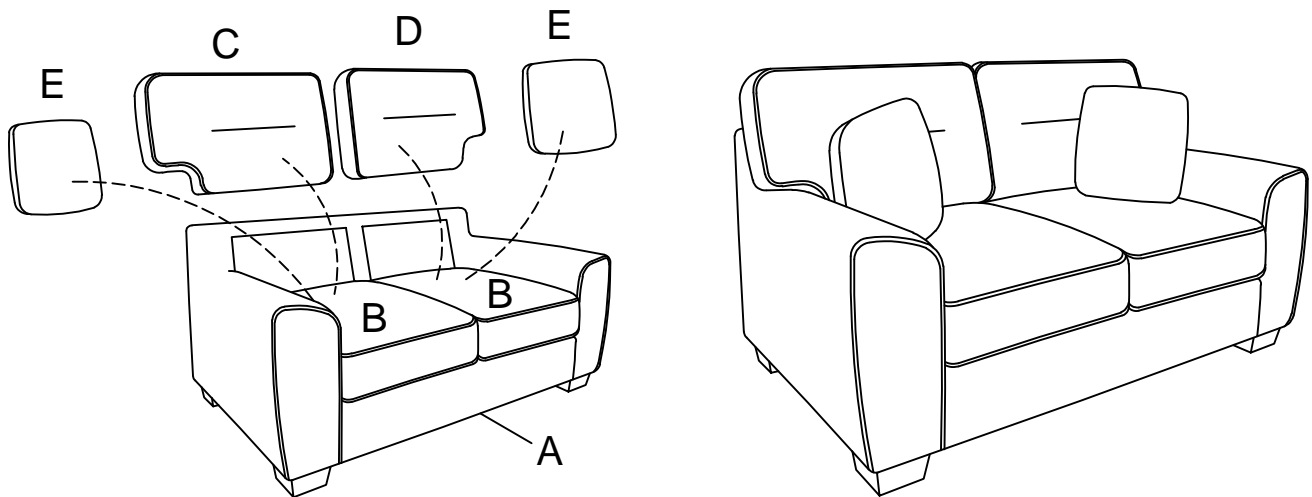

Care Instruction for Chenille Furniture:

In order to maintain the original appearance of your Chenille Furniture, please follow below simple care procedures:

- Avoid exposing furniture directly to sunlight or heating and air conditioning outlets. Sunlight and or exposure to heating and air conditioning outlets will fade/damage Chenille.
- Vacuum or wipe with a soft cloth to remove dust.
- Hardware may loosen over time. Periodically check to make sure all connection are tight, Re-tighten if necessary.







For items use on wooden floor, hard surfaces or carpets, it is recommended to Install protective pads under all legs and supports to avoid/prevent from damages/scratches and discoloration.

Assembly Instruction

Sofa (With 2 Pillows)

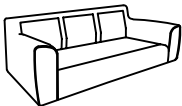

Note: Do not use power tools for assembly. Power tools increase the risk of over tightening which lead to splitting or cracking the wood.

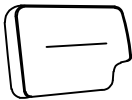
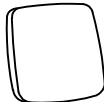
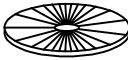
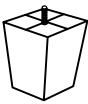
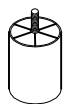
Component list

No	Drawing	Qty	Description
A		1	SEAT
B		3	SEAT CUSHION
C		1	LSF BACK CUSHION
D		1	MIDDLE BACK CUSHION
E		1	RSF BACK CUSHION
F		2	PILLOW (18"x18")
G		5	PLASTIC GASKET
H		4	PLASTIC LEGS (100*100*110mm)
I		1	PLASTIC LEG (60*115mm)

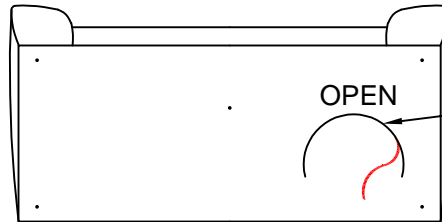
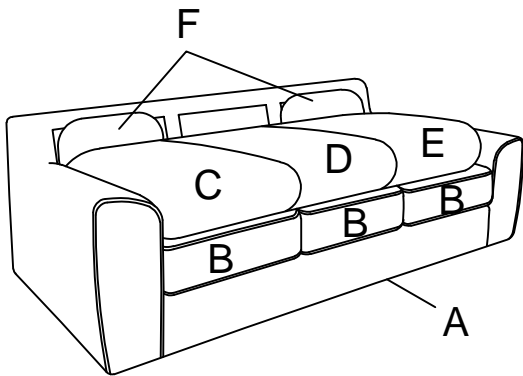
Step #1



-  G x 5
-  H x 4
-  I x 1

Step #2

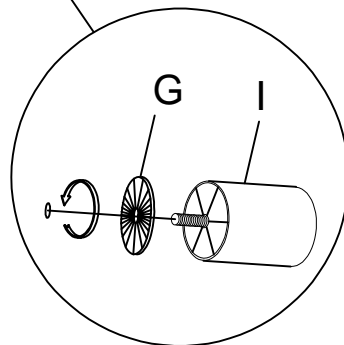
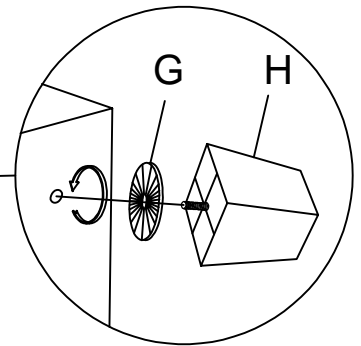
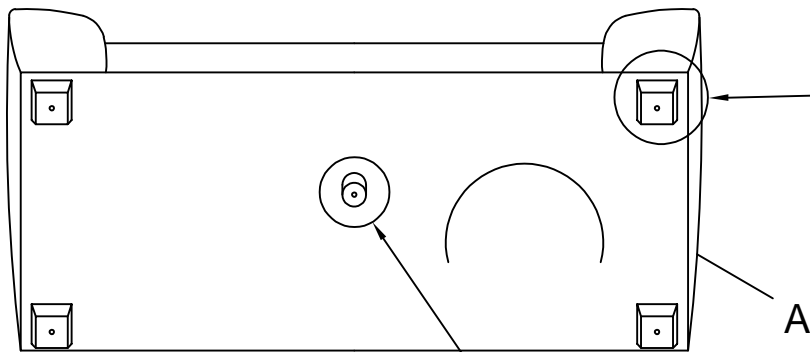

Step #3

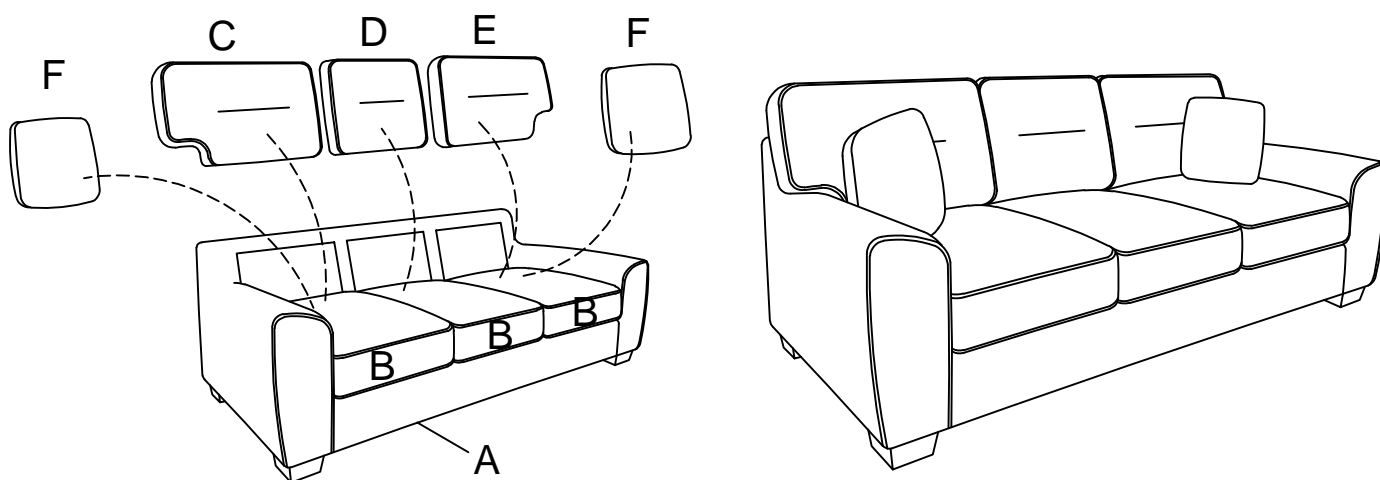

Care Instruction for Chenille Furniture:

In order to maintain the original appearance of your Chenille Furniture, please follow below simple care procedures:

- Avoid exposing furniture directly to sunlight or heating and air conditioning outlets. Sunlight and or exposure to heating and air conditioning outlets will fade/damage Chenille.
- Vacuum or wipe with a soft cloth to remove dust.
- Hardware may loosen over time. Periodically check to make sure all connection are tight, Re-tighten if necessary.



For items use on wooden floor, hard surfaces or carpets, it is recommended to Install protective pads under all legs and supports to avoid/prevent from damages/scratches and discoloration.