

ASSEMBLY INSTRUCTIONS

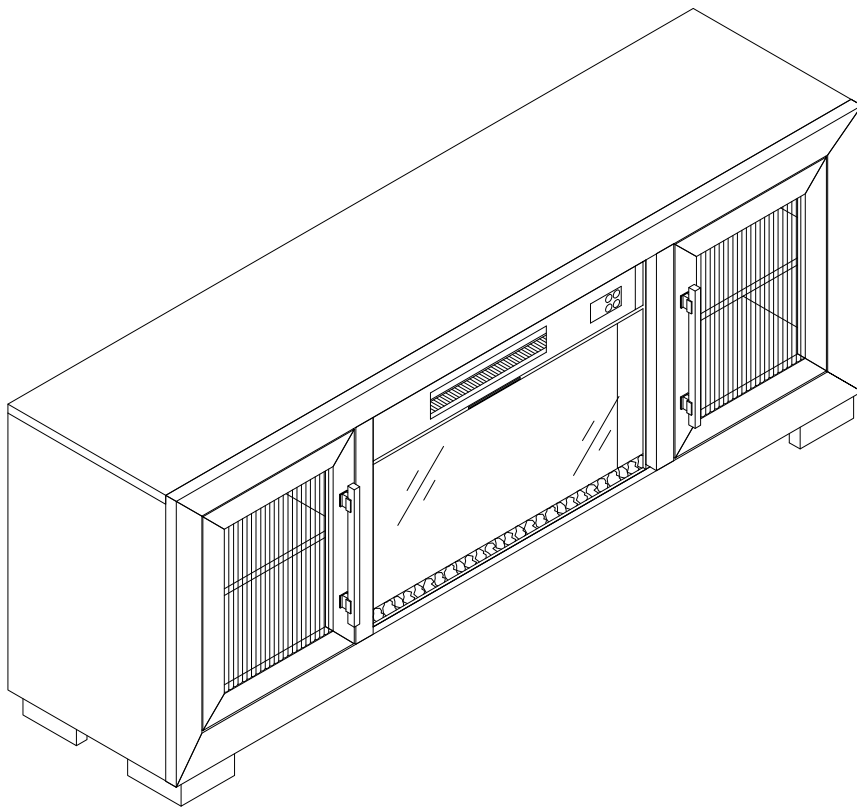

TOOLS REQUIRED



Screwdriver
(Not included)



(Included)
Allen Wrench



2 - People

ASSEMBLY RATING



EASY ————— DIFFICULT

The Assembly Rating is a 5-point system showing the level of effort needed to assemble a specific product.



CHECK BEFORE STARTING

- | | |
|---|--|
| <input type="checkbox"/> Are you missing anything?
Double-check all parts, hardware and accessories listed are all accounted for. | <input type="checkbox"/> Check out our Quick Tips!
We recommend reviewing the pre-assembly handouts. Even experts need a refresher now and then! |
| <input type="checkbox"/> Should we send any replacements?
Are there any irregularities or flaws in the parts? We can send replacements! | <input type="checkbox"/> Prep Time!
Please review the assembly instructions and all diagrams prior to assembling. |

PRE ASSEMBLY INTRODUCTION

We understand building ready-to-assemble furniture can be a challenging experience for some. To help avoid confusion, we have provided some helpful tips that may speed up the process.



Teamwork

ALWAYS have at least two people to help with transporting and assembling the product to avoid potential injury and/or damage.



Suitable Location

Assembling near the area of the intended location is highly recommended.



Sufficient Space

Make sure you have enough space to move around during the assembly.



Avoid Scratches

Use cardboard, blankets or a carpeted area while assembling furniture to prevent to prevent scratches and damages.

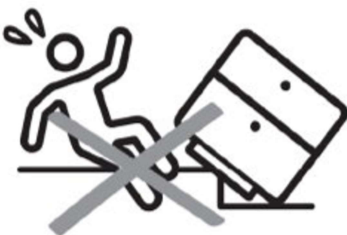

Flat Surface

Make sure the furniture rests on a flat and level surface with each leg evenly touching the floor.

ASSEMBLY AND CARE ADVICE



FAILURE TO FOLLOW THE GUIDELINES BELOW MAY RESULT IN INJURY AND/OR PROPERTY DAMAGE.



Position each part correctly and insert screws or bolts into their respective holes.

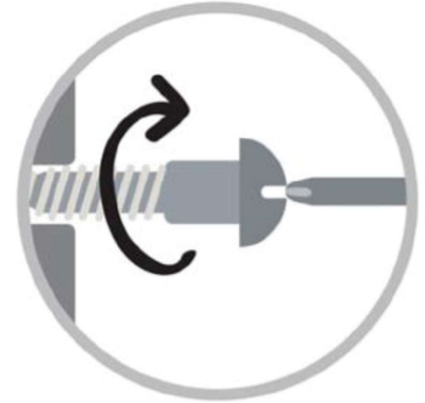

Turn clockwise to tighten and only tighten when step is completed or when instructed to do so.



Use the appropriate hand tools or power tools for assembly. Select steps, such as tightening screws and/or bolts, may require hand tools to avoid causing damage during assembly.



Save the instructions and store any supplied tools for later maintenance.



After two weeks, check and tighten any loose hardware and repeat again every six months thereafter.

IT IS THE USER'S RESPONSIBILITY TO MAINTAIN THE FURNITURE. THE HARDWARE MAY LOOSEN OVER TIME AND MAY CAUSE THE FURNITURE TO BE WOBBLY AND UNABLE TO SUPPORT ITS INTENDED WEIGHT CAPACITY. THIS MAY LEAD TO COLLAPSE AND MAY CAUSE SERIOUS INJURY.

IMPORTANT SAFETY INFORMATION!



WARNING



- **ALWAYS** keep electric cords, home furnishings, drapes, clothing, papers, or other combustibles at least 3 feet (0.9m) away from the front of this heater, and away from the bottom, sides, and rear of this heater.
- **DO NOT** place the heater near a bed because objects such as pillows or blankets can fall off the bed and be ignited by the heater.
- **DO NOT COVER** this heater or block the air vents at all. Doing so could cause a fire.
- **AVOID** fire or electric shock! **NEVER** insert or allow any foreign objects to enter the ventilation or exhaust openings of this heater.
- **Prevent Fire!** Keep all flammable liquids, like gasoline or paint, away from this heater. This heater produces arcing sparks that could ignite flammable liquids.
- **DO NOT** cover this heater in any manner. Doing so could block the air flow and cause the unit to overheat, or could ignite the material covering the heater.
- **NEVER** run the power cord under carpet, rugs, runners, or any other covering. Doing so could cause the cord or materials covering the cord to overheat.
- **AVOID FIRE!** Regularly inspect all air vents to make sure they are free from dust, lint, or other blockage. Unplug the unit and clean with a vacuum **ONLY**. **DO NOT** rinse or get wet.



WARNING



- **For residential use only!** **NOT** for commercial use! **NEVER** use this fireplace for other than its intended purpose.
- Use extreme caution if using this heater near children or invalids.
- **NEVER** leave this heater unattended. **ALWAYS** unplug this heater when not in use.
- This heater is hot when in use. **AVOID INJURY!** **DO NOT TOUCH** hot surfaces, or attempt to move this heater while it is hot.
- **ALWAYS** turn this heater off before unplugging it from the outlet.
- **AVOID INJURY!** Keep the cord from crossing traffic areas to avoid tripping.
- **NEVER** modify this fireplace. Doing so could result in **personal injury** or property damage. Modification of this fireplace completely voids all warranties.
- Discontinue use if this fireplace malfunctions or is dropped or damaged in any manner.
- **ALWAYS** store this heater in a dry location. **NEVER** use the fireplace if it has become wet.



WARNING



- Risk of **electric shock!** **DO NOT OPEN!** No user-serviceable parts inside!
- **ALWAYS** disconnect this unit from the power supply before performing any assembly or cleaning, before replacing the light bulb, or before relocating the electric fireplace.
- **NEVER** use this heater in bathrooms, laundry rooms, or any other location where the heater could fall into a bathtub or pool, become damp or come in contact with water.
- **NEVER** hang this unit on a wall directly below an electrical outlet.
- **NEVER** operate this heater if the power cord or plug has become damaged, or if the grounding pin is damaged or missing.
- Place the heater near a wall outlet so an extension cord is not needed. If an extension cord is needed, the gauge of the cord must be at least 14AWG, and the rating must be at least 1875 Watts. **NEVER** use a smaller gauge cord with a lower rating.

Doing so may result in fire or **electric shock**.

- Avoid hazards due to resetting of the thermal cut-off switch. **NEVER** control this unit with a timer, or allow it to be on a circuit regularly switched off by the utility.
- **ONLY** use this heater on a 110-120 Volt 15 Amp grounded circuit. **NEVER** overload the circuit. If this heater trips the circuit breaker, unplug all other appliances on the same circuit before the next use. Avoid plugging other appliances into the same circuit as this heater.
- **NEVER** plug this heater into an outlet that is old, cracked, or has any loose wires or connections. Plugging this heater into a faulty outlet could result in electric arcing within the outlet that could cause the outlet to overheat or catch fire.
- **ALWAYS** check your heater cord and plug connections with each use!
 - i) **MAKE SURE** the plug fits tight in the outlet! Faulty wall outlet connections or loose plugs can cause the outlet to overheat.
 - ii) Heaters draw more current than small appliances. Overheating may occur even if it has not occurred with the use of other appliances.
 - iii) During use check frequently to see if the plug outlet or faceplate is **HOT!**
 - iv) If the outlet or faceplate is **HOT**, discontinue use immediately and have a qualified electrician inspect and/or replace the faulty outlets.

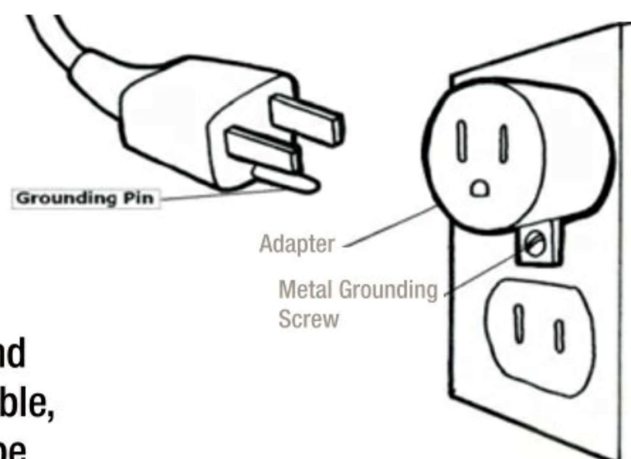

- The cord supplied with the heater has a plug with two blades (live and neutral) and one round pin (ground). If a 3-slot receptacle is not available, an adapter **MUST** be used. The adapter **MUST** be properly grounded to the outlet box (see figure at right).

IMPORTANT INSTRUCTIONS

SAVE THESE INSTRUCTIONS!

WHEN USING ELECTRICAL APPLIANCES, BASIC PRECAUTIONS SHOULD ALWAYS BE FOLLOWED TO REDUCE THE **RISK OF FIRE, ELECTRIC SHOCK, AND INJURY TO PERSONS**, INCLUDING THE FOLLOWING:

1. Read all instructions before installing or using this heater.
2. This heater is hot when in use. To avoid burns, do not let bare skin touch hot surfaces. Keep combustible materials, such as furniture, pillows, bedding, papers, clothes, etc. and curtains at least 3 feet (0.9m) from the front of the heater and keep them away from the sides and rear (sides and rear restrictions apply to location dedicated heaters only).
3. Extreme caution is necessary when any heater is used by or near children or invalids and whenever the heater is left operating and unattended.
4. Do not operate any heater after it malfunctions. Disconnect power at service panel and have heater inspected by a reputable electrician before reusing.
5. Do not use outdoors. (Omitted if the heater is intended for outdoor use.)
6. To disconnect heater, turn controls to off, and turn off power to heater circuit at main disconnect panel (or operate internal disconnect switch if provided).
7. Do not insert or allow foreign objects to enter any ventilation or exhaust opening as this may cause an **electric shock** or fire, do not block air intakes or exhaust in any manner.
8. To prevent a possible fire, do not block air intakes or exhaust in any manner.
9. A heater has hot and arcing or sparking parts inside, Do not use it areas where gasoline, paint, or flammable vapors or liquids are used or stored.
10. Use this heater only as described in this manual. Any other use not recommended by the manufacturer may cause fire, **electric shock**, or **injury to persons**.
11. This heater may include an audible or visual alarm to warn that parts of the heater are getting excessively hot. If the alarm sounds (or illuminates), immediately turn the heater off and inspect for any objects on or adjacent to the heater that may have blocked the airflow or otherwise caused high temperatures to have occurred. **DO NOT OPERATE THE HEATER WITH THE ALARM SOUNDING (OR ILLUMINATING).**

12. **“SAVE THESE INSTRUCTIONS”**

60" TV STAND WITH FIRE PLACE



- Please keep instructions for future reference.
- Check the quantity and irregularity of parts and hardware before you start.

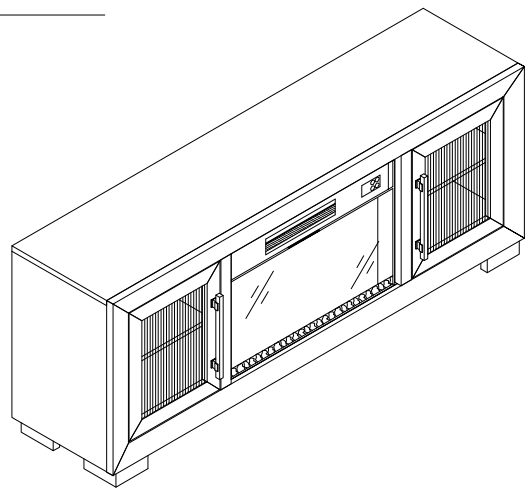

PARTS

1

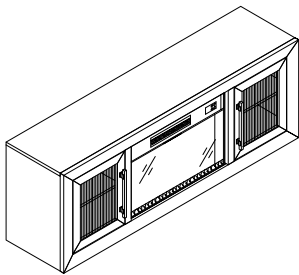

TV Stand
1pc

2

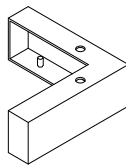

Leg
4pcs

3

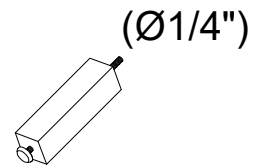

Support Leg
71x35x35mm
2pcs

4

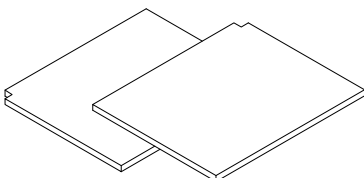

Adjustable Shelves
2pcs

HARDWARE

A

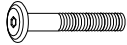

Bolt
Ø5/16" x 1"
8pcs

B



Lock Washer
Ø5/16"x13mm
8pcs

C



Flat Washer
Ø5/16"x19mm
8pcs

D



Allen Key M4
1pc

E



Screw
Ø3x12mm
8pcs

F

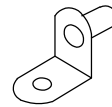

Adjustable Pin
8pcs

G

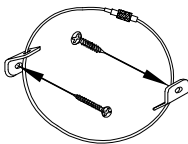

Tipping-Restriant
1set

ASSEMBLY INSTRUCTIONS

1

Part ① x1pc

Part ② x4pcs

Part ③ x2pcs

Hardware A x8pcs

Hardware B x8pcs

Hardware C x8pcs

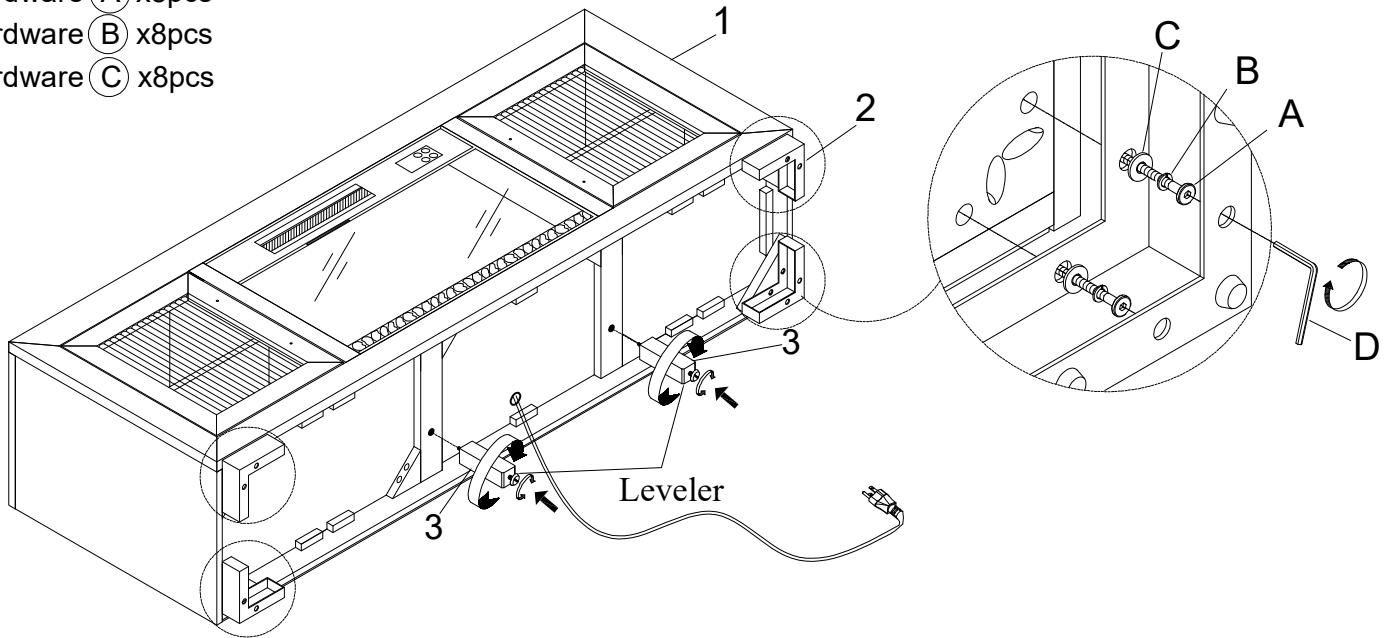

2

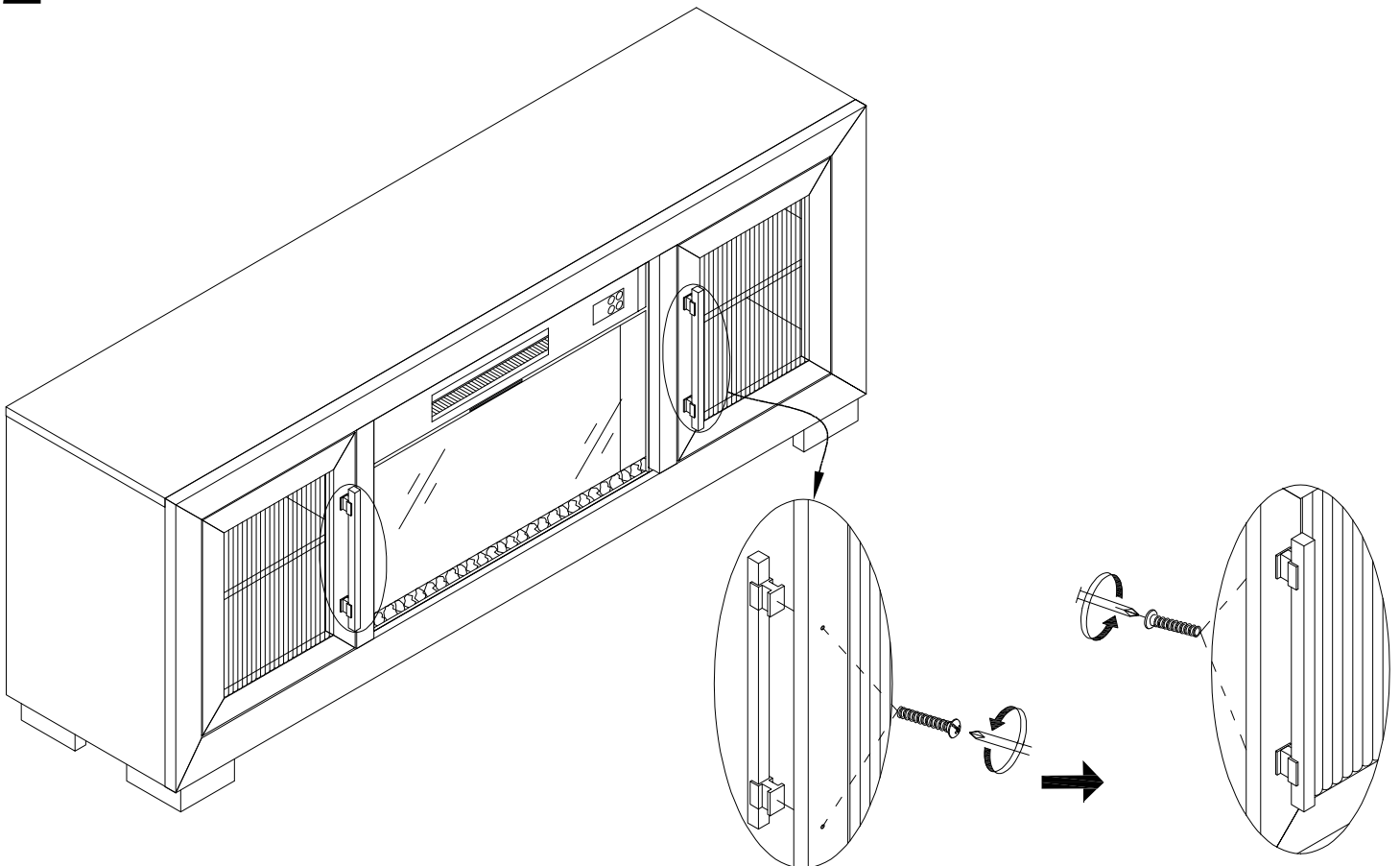

ASSEMBLY INSTRUCTIONS

3

Part ④ x2pcs

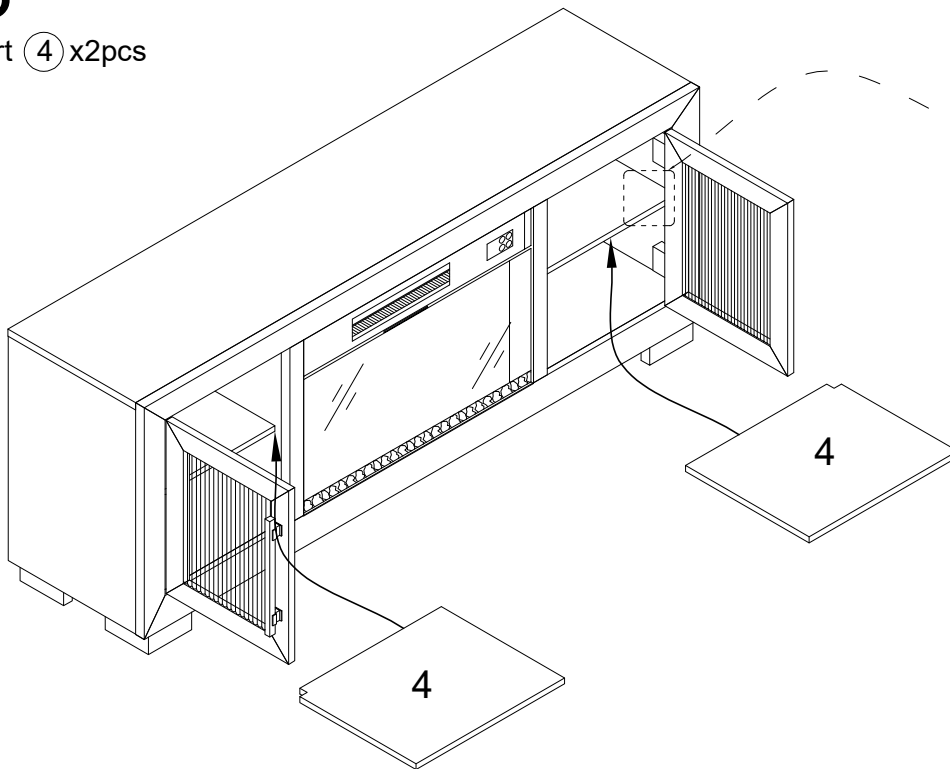

Tournevis-Non fourni /
Screwdriver-Not provided

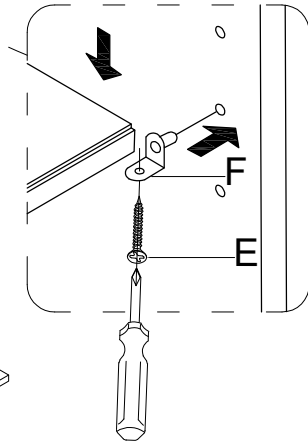

4

Hardware ⑥ x1Set

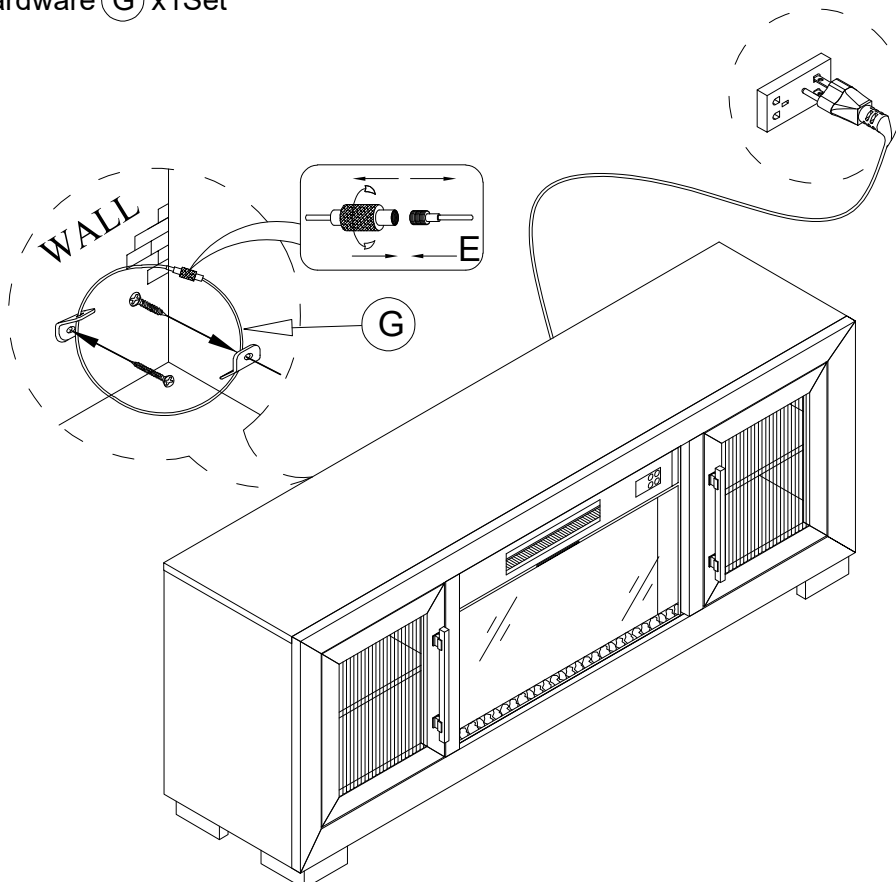

ASSEMBLY COMPLETED



Please ensure the furniture rests on an even and flat surface. If the product wobbles or feels loose, double-check all bolts and/or screws are properly tightened and secured.



Keep this handy!

Please retain this instruction manual and any order-related information for future reference.



Lift, don't drag!

To avoid damage to product please always LIFT the product when transporting or adjusting the placement.

This product is intended for RESIDENTIAL USE ONLY and not for commercial use.