

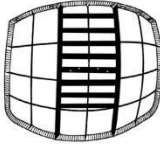

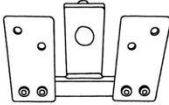







RATTAN SWIVEL CHAIR

Installation Instructions

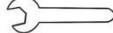
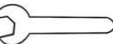

Parts List

Accessories							
	A	1	B	1	C	1	
							
	D	1	E	1			
Tools					with a spring washer 		
	M-6,30mm	4	M-8,20mm	4	M-8,20mm	1	
	M-8 		M-6  M-8  		M-6  M-8 		
	Iron gasket		Hexwrench		Wrench		
<p>Tips: Confirm all components are present before installation</p>							

Step 1:

Attach seat parts (A & B).

Use 4 screws (M6,30mm).

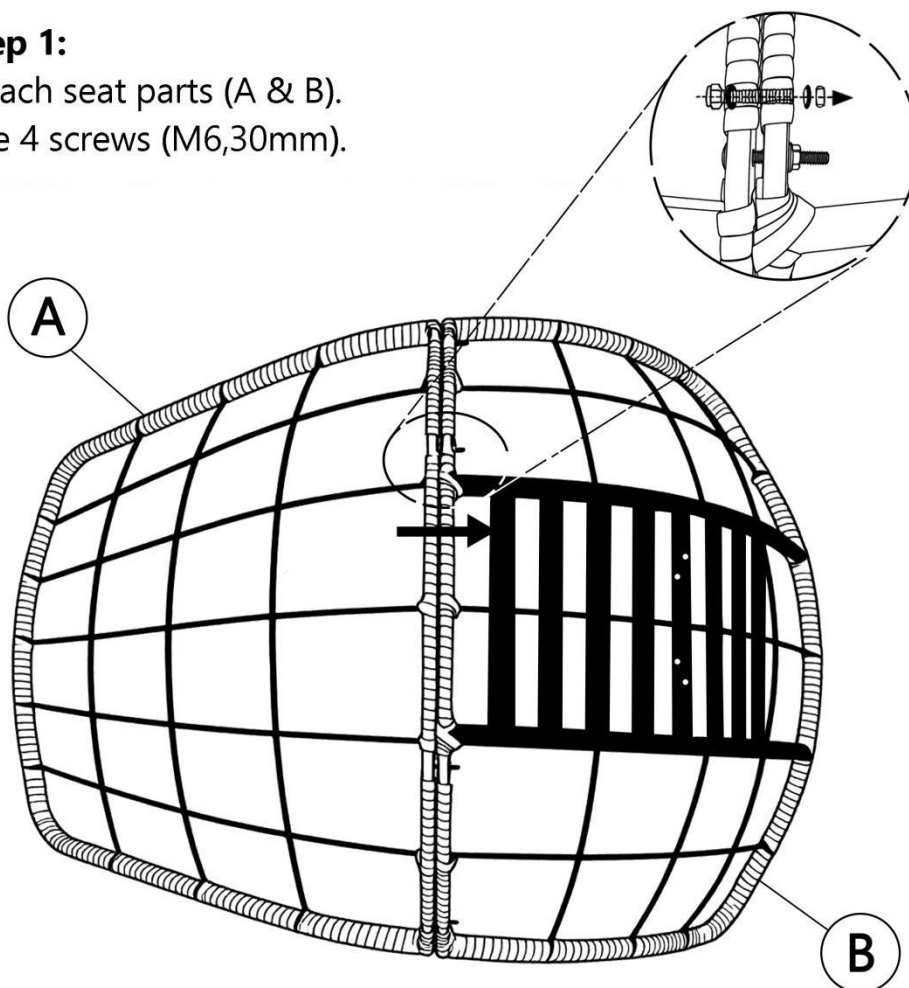

Step 2:

Attach seat parts (B & C). Use 4 screws (M8,20mm).

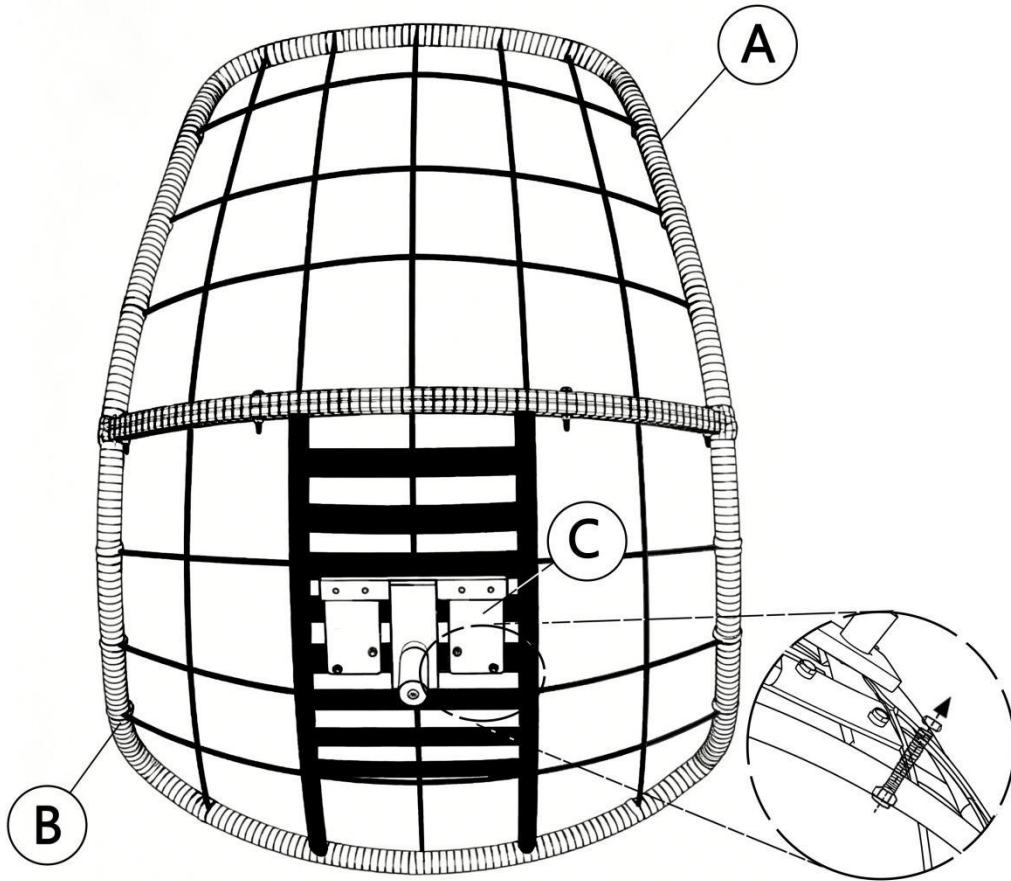

Step 3:

Insert part (D) into the seat .

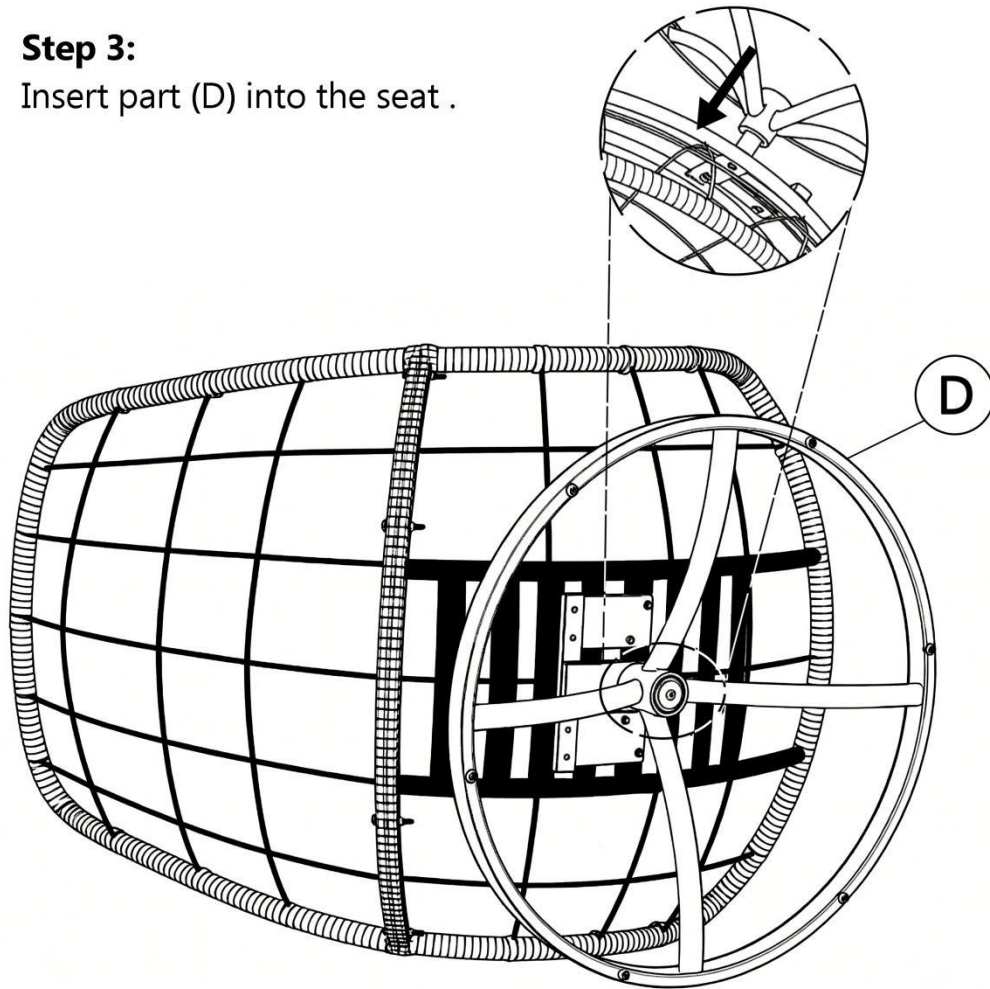

Step 4:

Fix the bottom of the chair.

Use M8 Iron gasket & 1 screw
(M8, 20mm) with a spring washer.

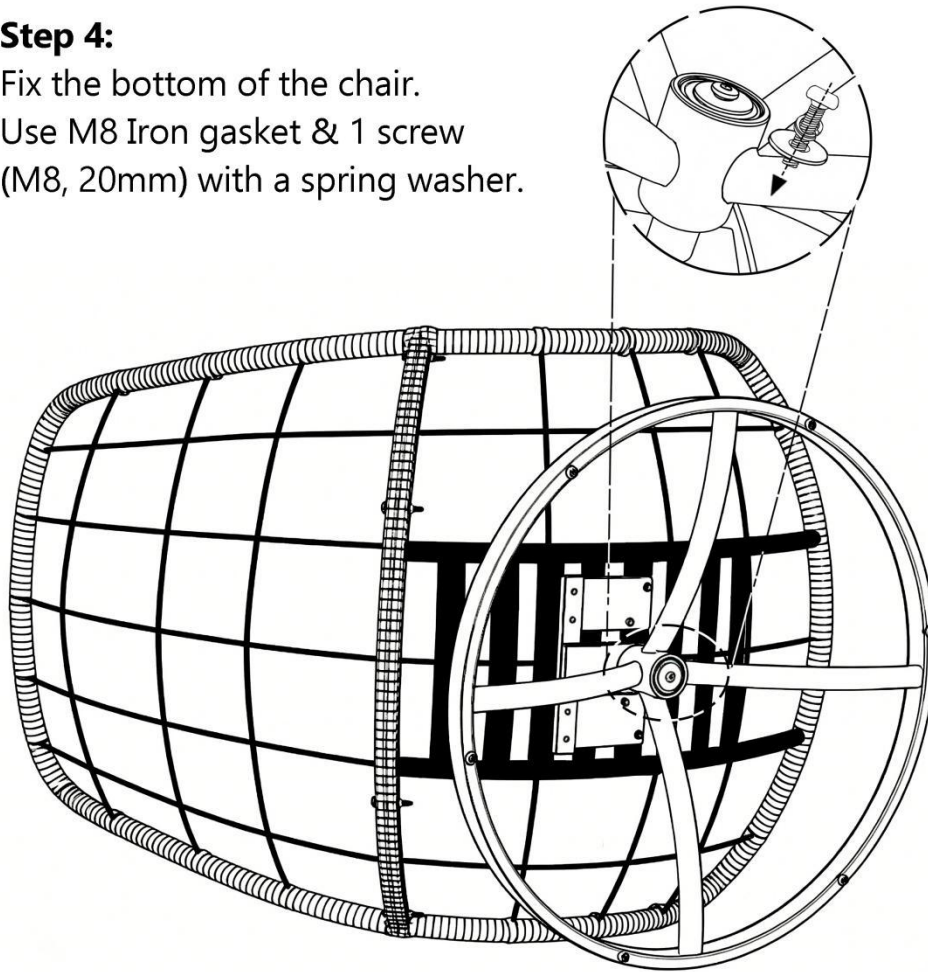

Step 6:

Put the cushions on, and finish the assembly!

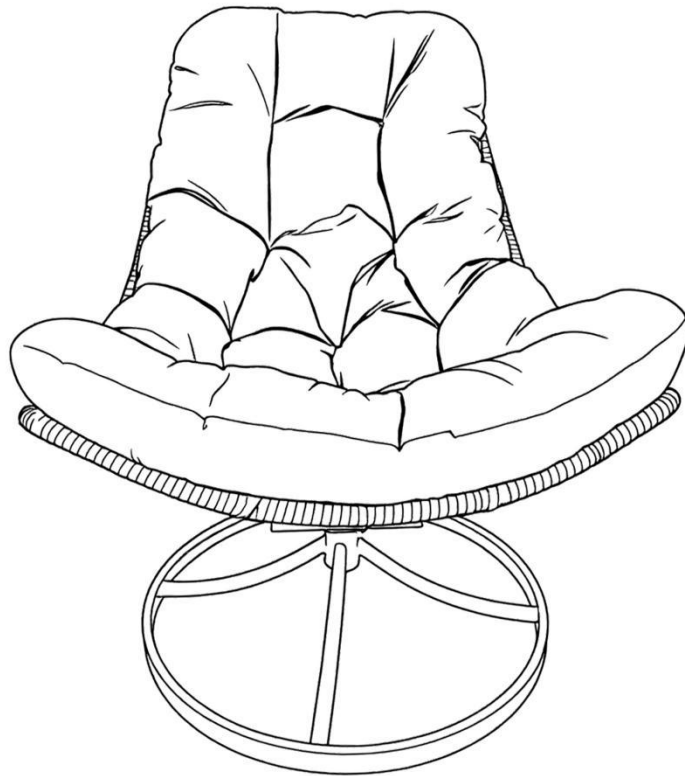

Rattan Swivel Chair

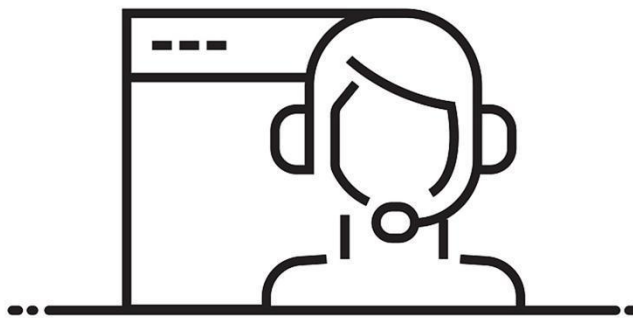

ONLINE SUPPORT

Please read the installation guide carefully before installation
If you have any questions during the installation process
you can contact us and we will provide you a detailed guidance