

# ASSEMBLY INSTRUCTIONS

## BED - FULL

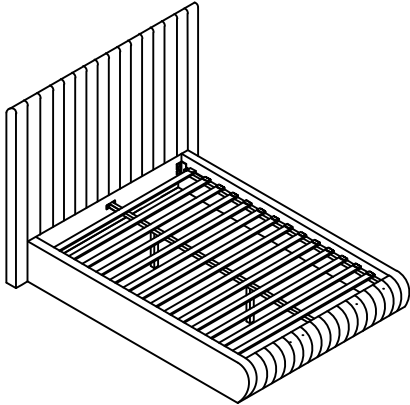

### + Parts Included

① Head Board (1pc)

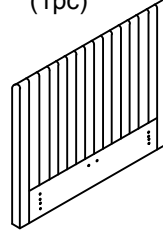

② Foot Board (1pc)

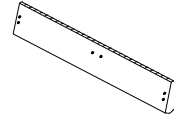

③ Side Rails (2pcs)

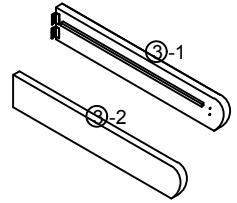

④ Center Support Bar (1pc)



⑤ Support Legs (2pcs)



⑥ Bracket (2pcs)



⑦ Slats joint (1set=13pcs)

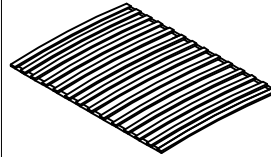

\*Slats come packed in the bottom of headboard carton.

### + Do Not Use Power Tools

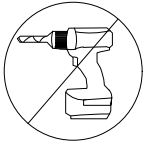

### + Suggested Adults

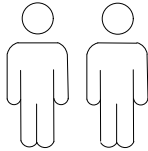

#### NOTE :

- 1 Read instructions cover to cover.
- 2 Save all packaging until assembly is completed.

### 1 IMPORTANT SAFETY INFORMATION

Do not assemble the product if any of the following parts arrived damaged:

- Part #③ -Side Rails
- Part #④ -Center Support Bar
- Part #⑤ -Support Legs
- Part #⑦ -Slats joint

### 2 IMPORTANT ASSEMBLY INFORMATION

Assembly Step ② Ensure the side rail bracket is fully hooked onto bolt **A** loosely threaded with both washers on the **OUTSIDE** of the bracket first, then proceed to fully tightening all 4 corners.

\*Slats come packed in the bottom of headboard carton.

### + Hardware Included

A Bolt M8\*40mm (24pcs)



B Spring Washer (16pcs)



C Flat Washer  $\varnothing 20$ (24pcs)



D M8 Allen Key (1pc)



E Nut M8\*13mm (4pcs)



F Spanner (1pc)



# ASSEMBLY INSTRUCTIONS

## BED - FULL

