

5/8" DRAPERY ROD INSTALLATION INSTRUCTIONS - 48-86" DOUBLE ROD SET

Care Instructions: Clean with a soft cloth. Do not use abrasive cleaning agents, solvents or polishes.

SET INCLUDES:

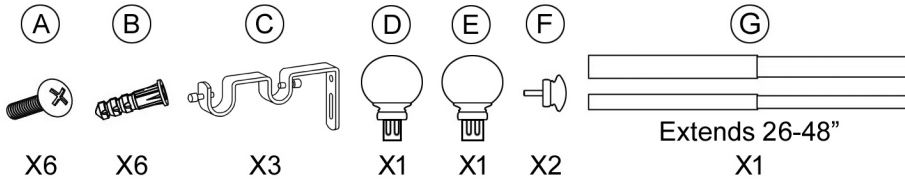

Note: Finial (D) fits to the smaller diameter rod - Finial (E) fits to the larger diameter rod.

YOU WILL NEED:

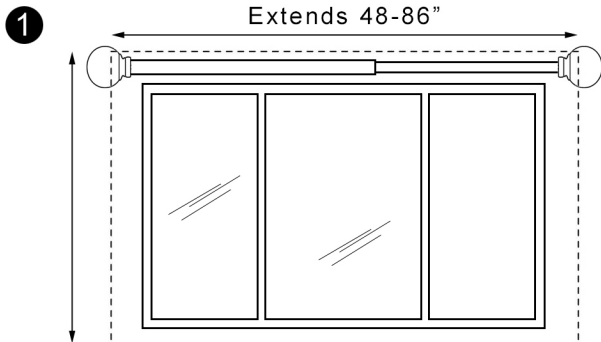
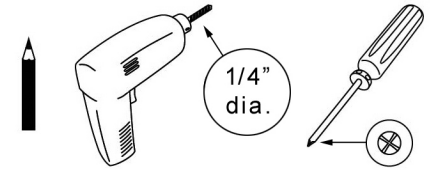

Before installation, measure windows to determine appropriate drapery rod length.

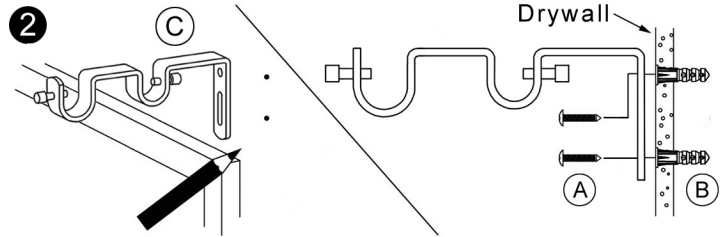

Use bracket (C) as a guide to mark location for mounting screws (A). Drill pilot holes into wall with 1/4" drill bit (not included). Insert wall anchors (B) and attach bracket (C) using mounting screws (A). Wall anchors may not be necessary if drilling into studs.

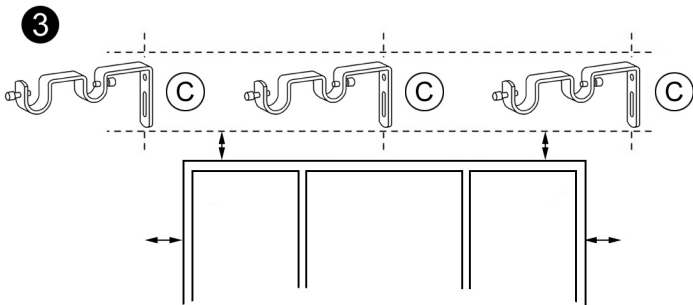

Repeat steps 2-3 for additional brackets. Use level if necessary.

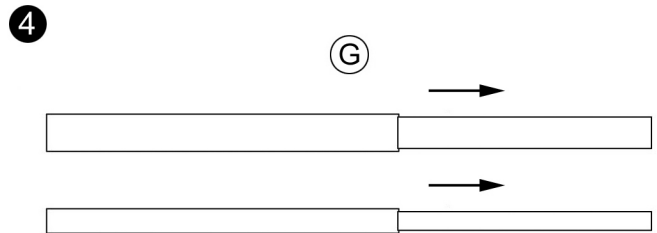

Extend telescoping rods (G) slightly.

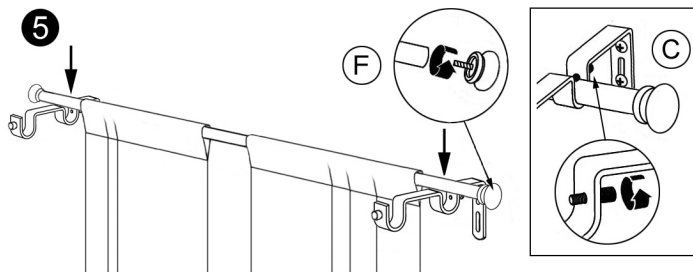

Place drapery panels (not included) onto smaller diam. telescoping drapery rod and extend to desired length. Hang rod on brackets. Screw finials (F) into ends of rod and tighten set screws on brackets (C).

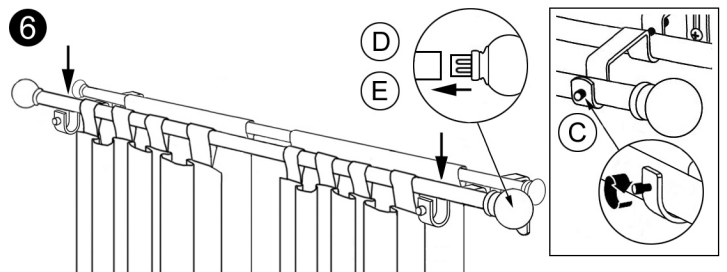

Place drapery panels (not included) onto larger diam. telescoping drapery rod and extend to desired length. Hang rod on brackets. Insert finials (D & E) into ends of rod and tighten set screws on brackets (C).