

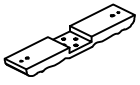

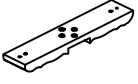
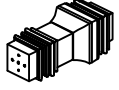
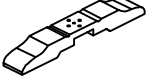
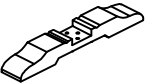
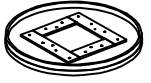
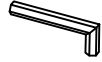
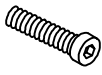

ASSEMBLY INSTRUCTION

NO.	PARTS LIST		Q' TY
A		ON THE CROSS	1
B		ON THE CROSS	1
C		FOULING	1
D		PAW	1
E		PAW	1
F		FAUX MARBLE TOP	1

NO.	HARDWARE LIST		Q' TY
1		WRENCH $\phi 5/16"$	1
2		BOLT $\phi 5/16 \times 2-3/4"$	4
3		FLAT WASHER $\phi 5/16"$	12
4		SPRING WASHE $\phi 5/16"$	12
5		BOLT $\phi 5/16 \times 3-1/2"$	4
6		BOLT $\phi 5/16 \times 2-1/4"$	4
7		Phellem $\phi 10 \times 35\text{mm}$	6

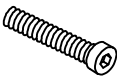
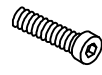
STEP1

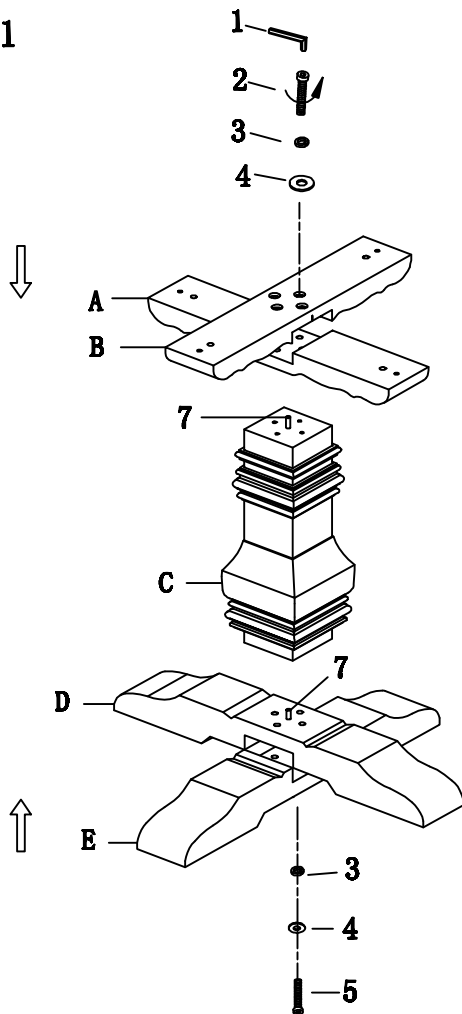

STEP2

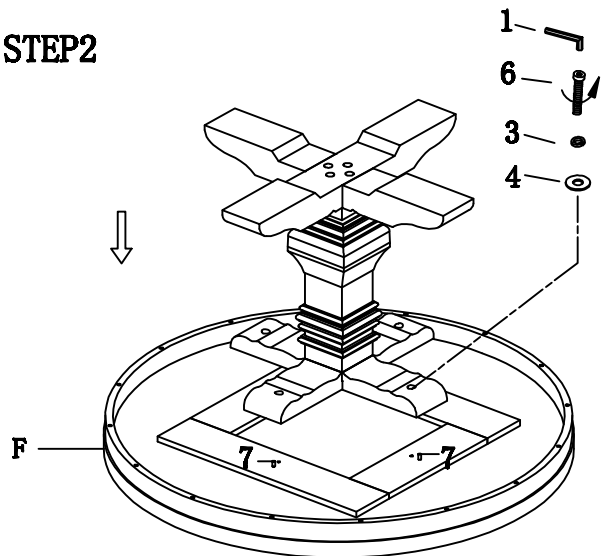

STEP3

