



**INSTRUCTIONS D'ASSEMBLAGE  
ASSEMBLY INSTRUCTIONS**

---

**CREDESCENCE -  
BLANC / 2 TIROIRS A ROULETTES**

**OFFICE CABINET -  
WHITE WITH 2 DRAWERS ON CASTORS**



**POUR DE L'ASSISTANCE OU POUR COMMANDER  
DES PIÈCES CONTACTEZ NOTRE DÉPARTEMENT  
DE SERVICE À LA CLIENTÈLE.**

**FOR ASSISTANCE OR TO ORDER PARTS  
CONTACT OUR CUSTOMER SERVICE DEPARTMENT**

## LISTE DES PIÈCES PARTS LIST

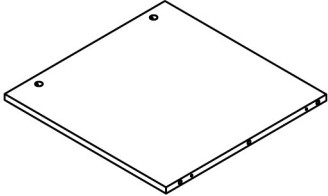
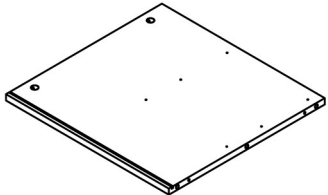
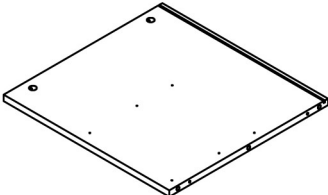
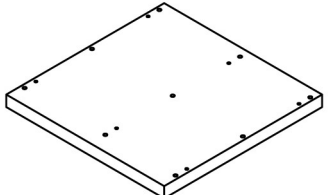
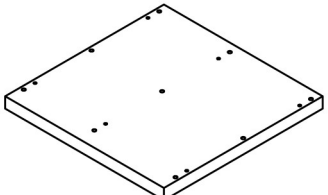
PIÈCE / PART #	IMAGE	DESCRIPTION	QTY / QTÉ
<b>1</b>		<b>FRONT FACING LEFT SIDE PANEL PANNEAU DE CÔTÉ GAUCHE</b>	<b>1</b>
<b>2</b>		<b>FRONT FACING RIGHT SIDE PANEL PANNEAU DE CÔTÉ AVANT DROIT</b>	<b>1</b>
<b>3</b>		<b>DIVIDER PANEL PANNEAU DE DIVISION</b>	<b>1</b>
<b>4</b>		<b>BOTTOM PANEL PANNEAU DU BAS</b>	<b>1</b>
<b>5</b>		<b>TOP PANEL PANNEAU DE SURFACE</b>	<b>1</b>

## LISTE DES PIÈCES PARTS LIST

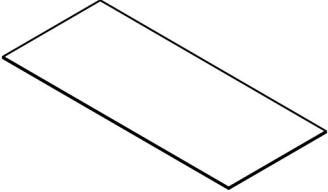
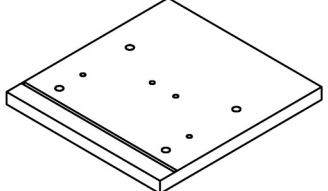
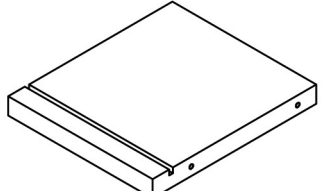
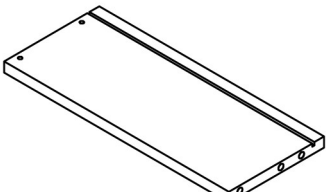
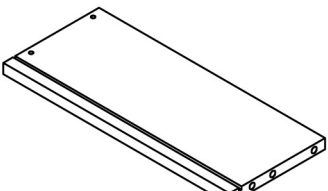
PIÈCE / PART #	IMAGE	DESCRIPTION	QTY / QTÉ
<b>6</b>		<b>BACK PANEL PANNEAU ARRIÈRE</b>	<b>1</b>
<b>7</b>		<b>DRAWER FRONT PANEL PANNEAU AVANT TIROIR</b>	<b>2</b>
<b>8</b>		<b>DRAWER BACK PANEL PANNEAU ARRIÈRE TIROIR</b>	<b>2</b>
<b>9</b>		<b>DRAWER SIDE PANEL PANNEAU DE CÔTÉ TIROIR</b>	<b>2</b>
<b>10</b>		<b>DRAWER SIDE PANEL PANNEAU DE CÔTÉ TIROIR</b>	<b>2</b>

**LISTE DES PIÈCES**  
**PARTS LIST**

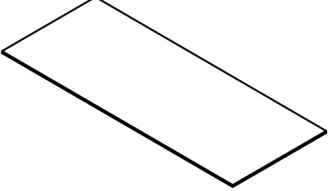
PIÈCE / PART #	IMAGE	DESCRIPTION	QTY / QTÉ
11		DRAWER BOTTOM PANEL PANNEAU DU BAS TIROIR	2

## LISTE DES PIÈCES DE MONTAGE HARDWARE LIST

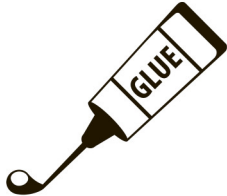
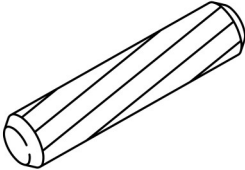
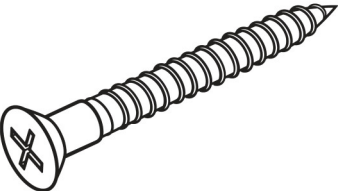
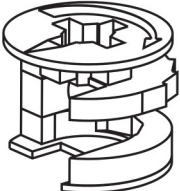
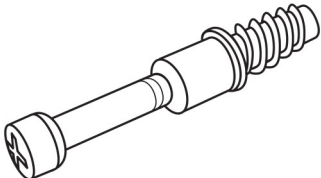
PIÈCE / PART #	IMAGE	DESCRIPTION	QTY / QTÉ
<b>A</b>		GLUE COLLE	1
<b>B</b>		WOOD DOWEL - Ø3/8" X 1 1/8" GOUJON DE BOIS - Ø3/8" X 1 1/8"	26
<b>C</b>		ASSEMBLING SCREW - 1 5/8" VIS D'ASSEMBLAGE - 1 5/8"	6
<b>D</b>		CAM LOCK CONNECTOR - Ø5/8" X 1/2" ÉCROU CAM LOCK - Ø5/8" X 1/2"	10
<b>E</b>		CAM LOCK SCREW - 1 3/8" VIS CAM LOCK - 1 3/8"	10

**LISTE DES PIÈCES DE MONTAGE**  
**HARDWARE LIST**

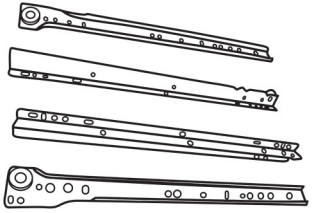
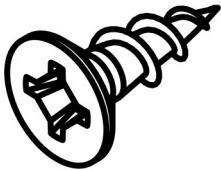
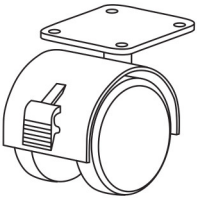
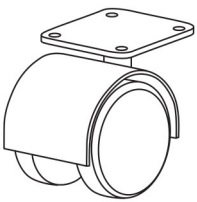
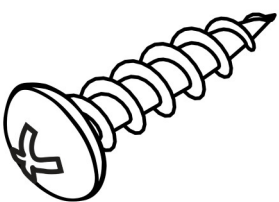
PIÈCE / PART #	IMAGE	DESCRIPTION	QTY / QTÉ
F		<p>METAL DRAWER SLIDE - 13 3/4"</p> <p>COULISSE DE MÉTAL - 13 3/4"</p>	2
G		<p>ASSEMBLING SCREW - 1/2"</p> <p>VIS D'ASSEMBLAGE - 1/2"</p>	24
H		<p>WHEEL - Ø2"</p> <p>ROUE - Ø2"</p>	2
I		<p>WHEEL - Ø2"</p> <p>ROUE - Ø2"</p>	2
J		<p>ASSEMBLING SCREW - 5/8"</p> <p>VIS D'ASSEMBLAGE - 5/8"</p>	16

## LISTE DES PIÈCES DE MONTAGE HARDWARE LIST

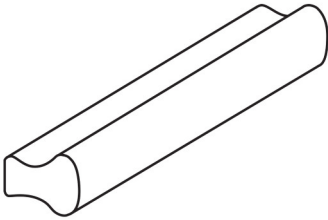
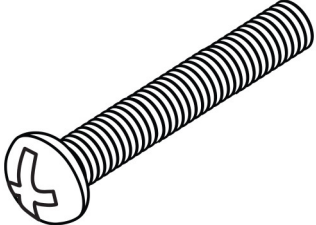
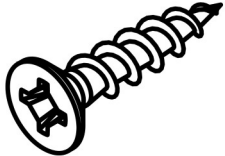
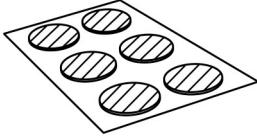
PIÈCE / PART #	IMAGE	DESCRIPTION	QTY / QTÉ
<b>K</b>		HANDLE - 2" POIGNÉE - 2"	2
<b>L</b>		ASSEMBLING BOLT - 7/8" BOULON D'ASSEMBLAGE - 7/8"	4
<b>M</b>		ASSEMBLING SCREW - 1 3/8" VIS D'ASSEMBLAGE - 1 3/8"	8
<b>N</b>		FINISHING STICKER - Ø3/4" COLLANT DE FINITION - Ø3/4"	10

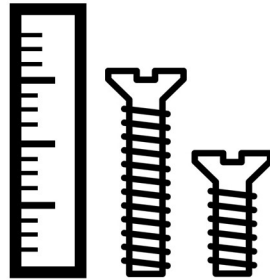

**OUTIL DE VÉRIFICATION DE DIMENSIONS DES PIÈCES  
HARDWARE DIMENSIONS VERIFICATION TOOL**

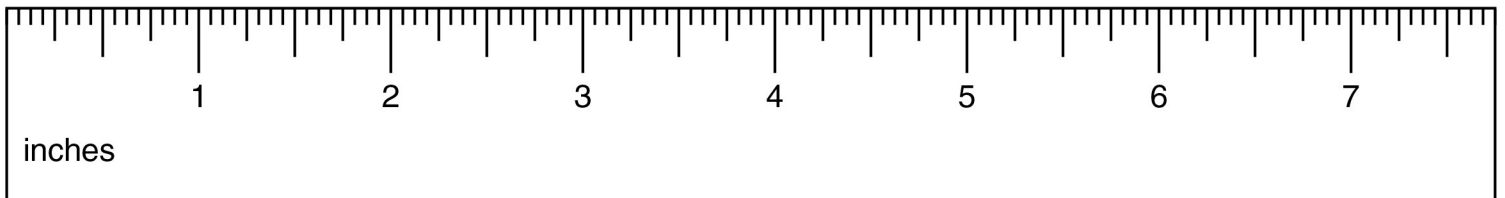

ÉTAPE / STEP 1

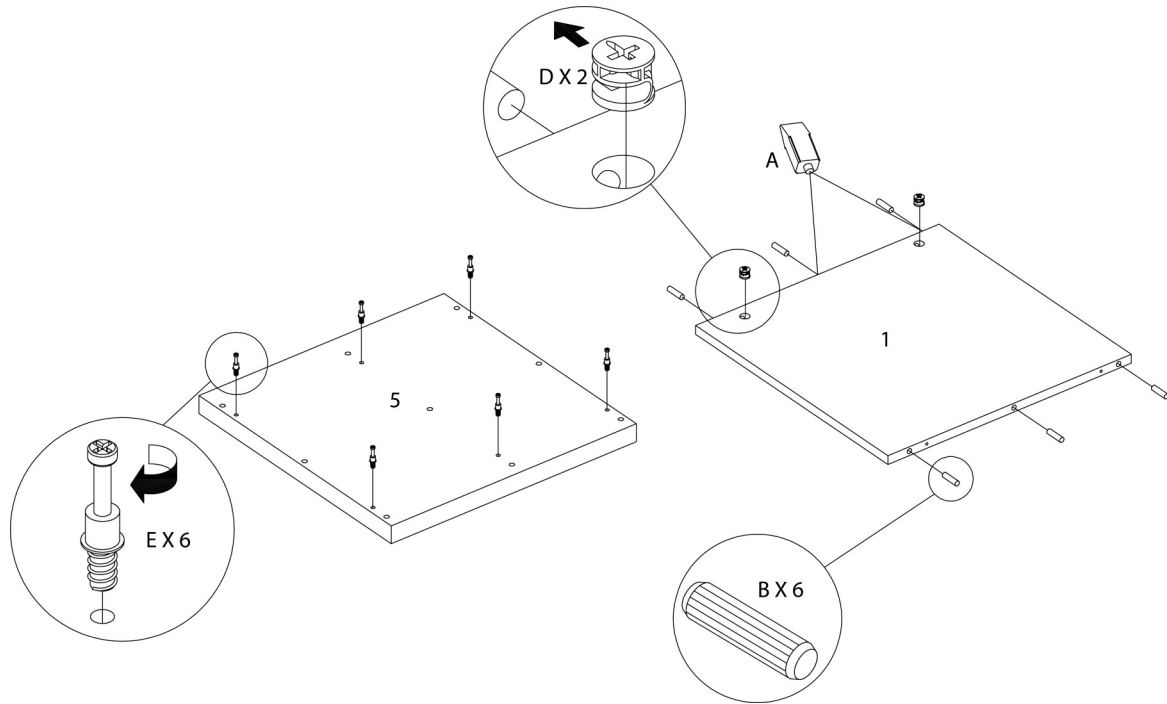

ÉTAPE / STEP 2

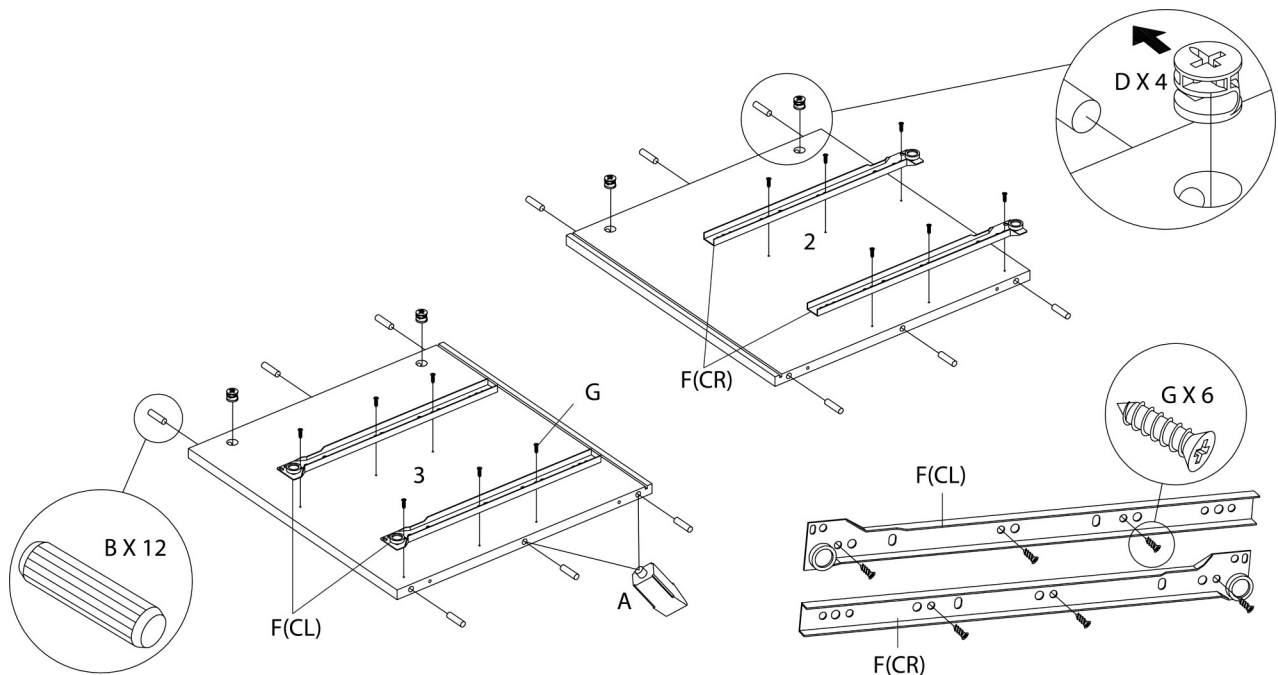

**ÉTAPE / STEP 3**

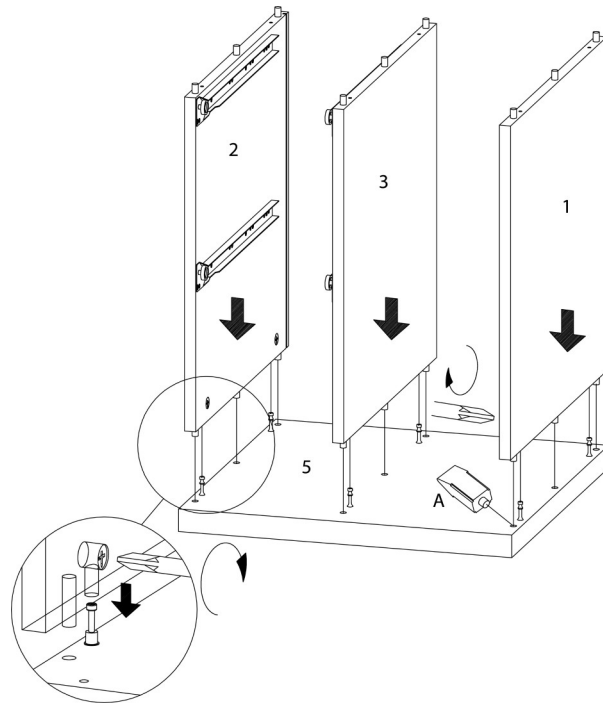

**ÉTAPE / STEP 4**

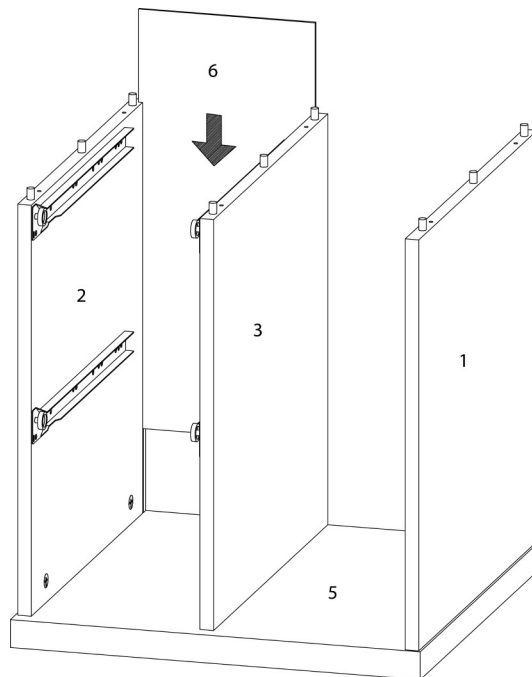

ÉTAPE / STEP 5

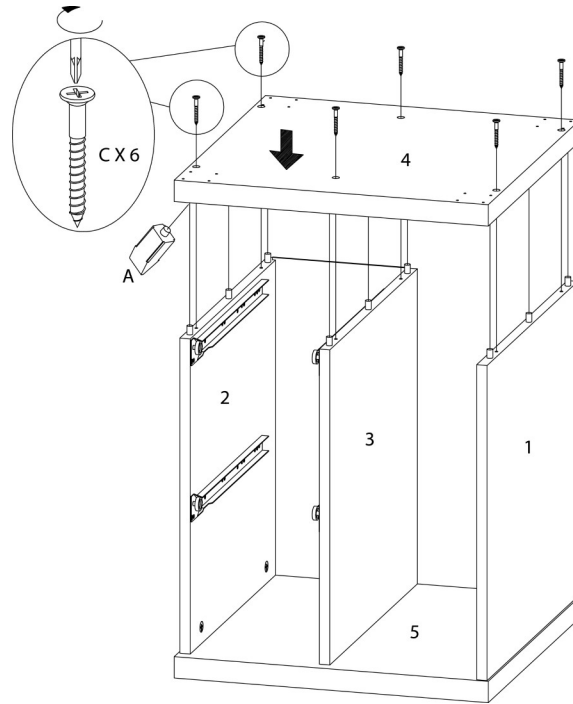

ÉTAPE / STEP 6

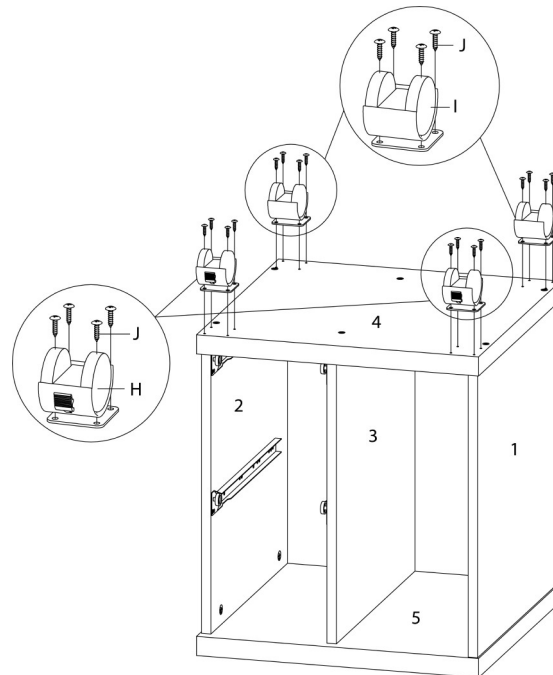

ÉTAPE / STEP 7

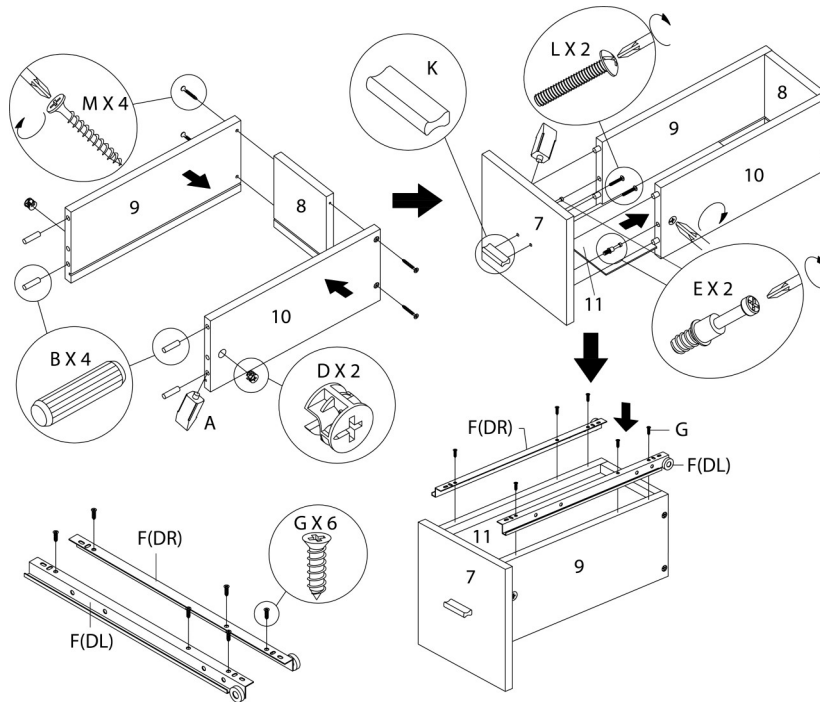

ÉTAPE / STEP 8

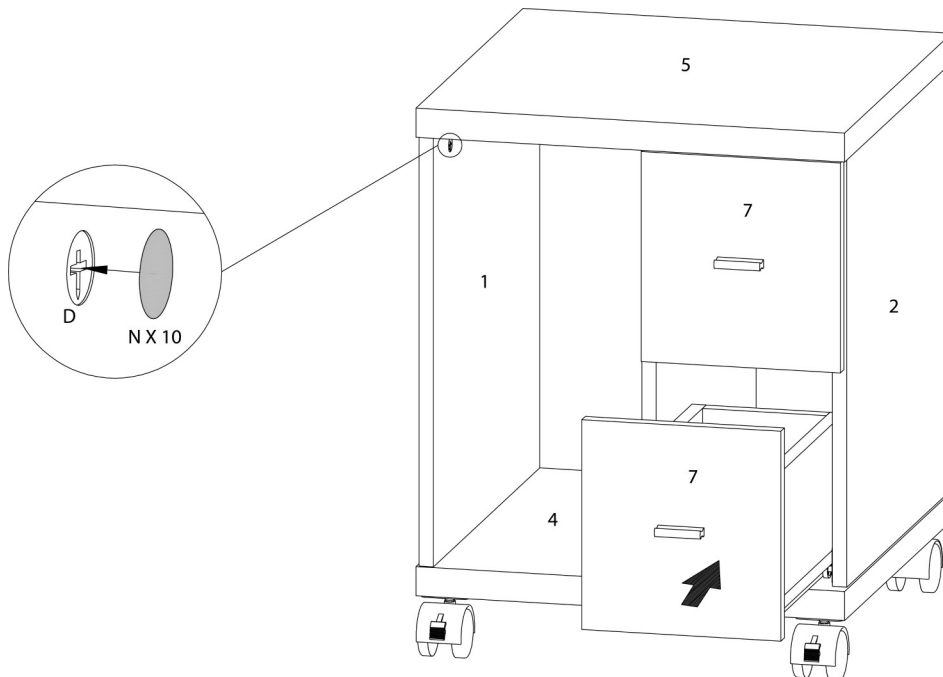

ÉTAPE / STEP 9

