

# ASSEMBLY INSTRUCTION

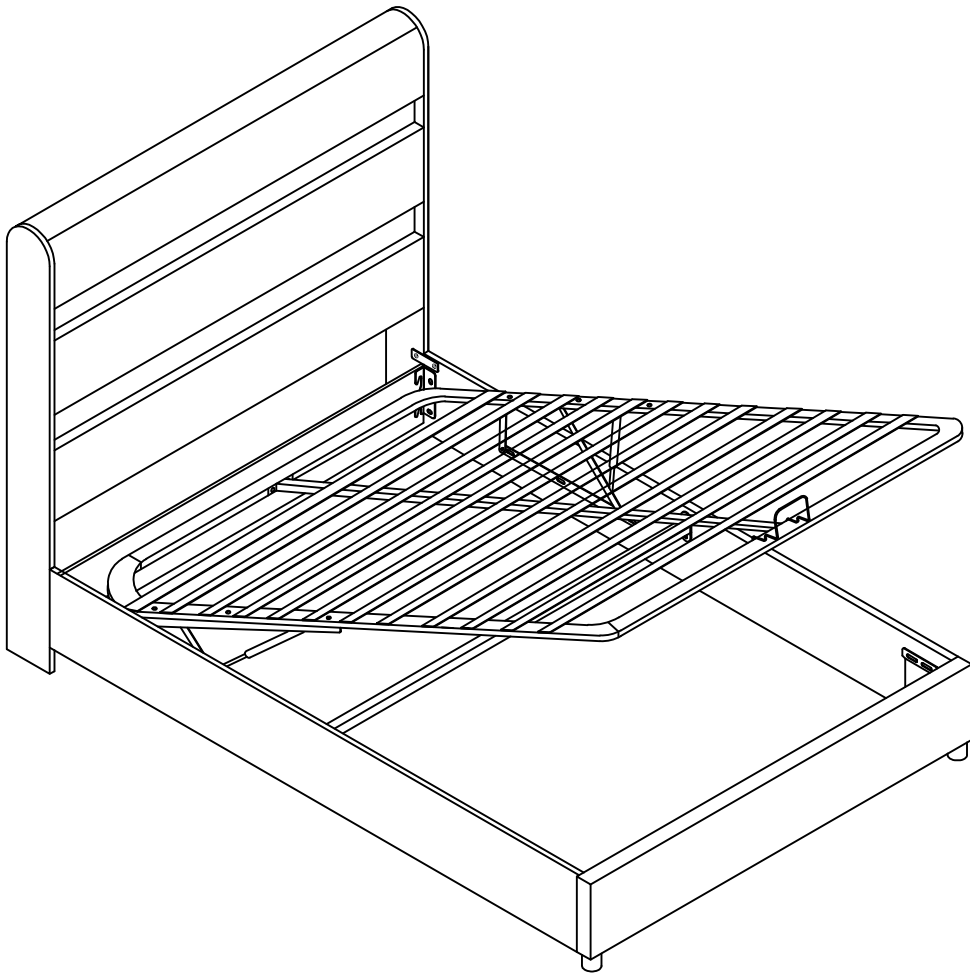

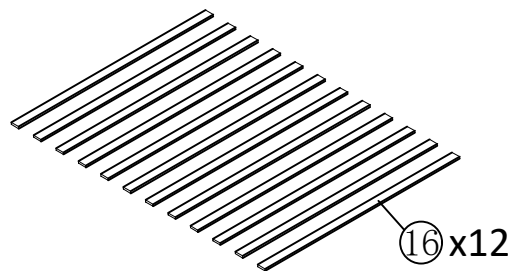

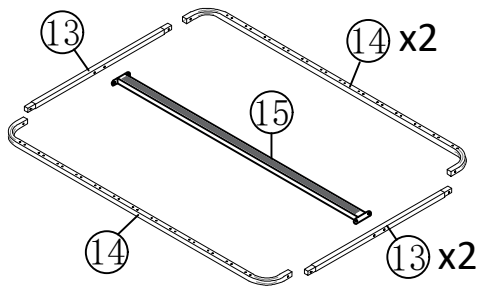

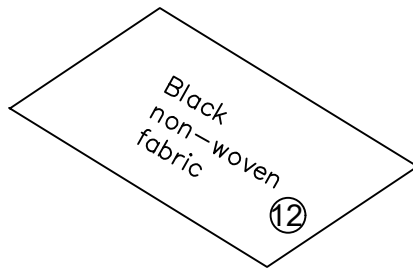
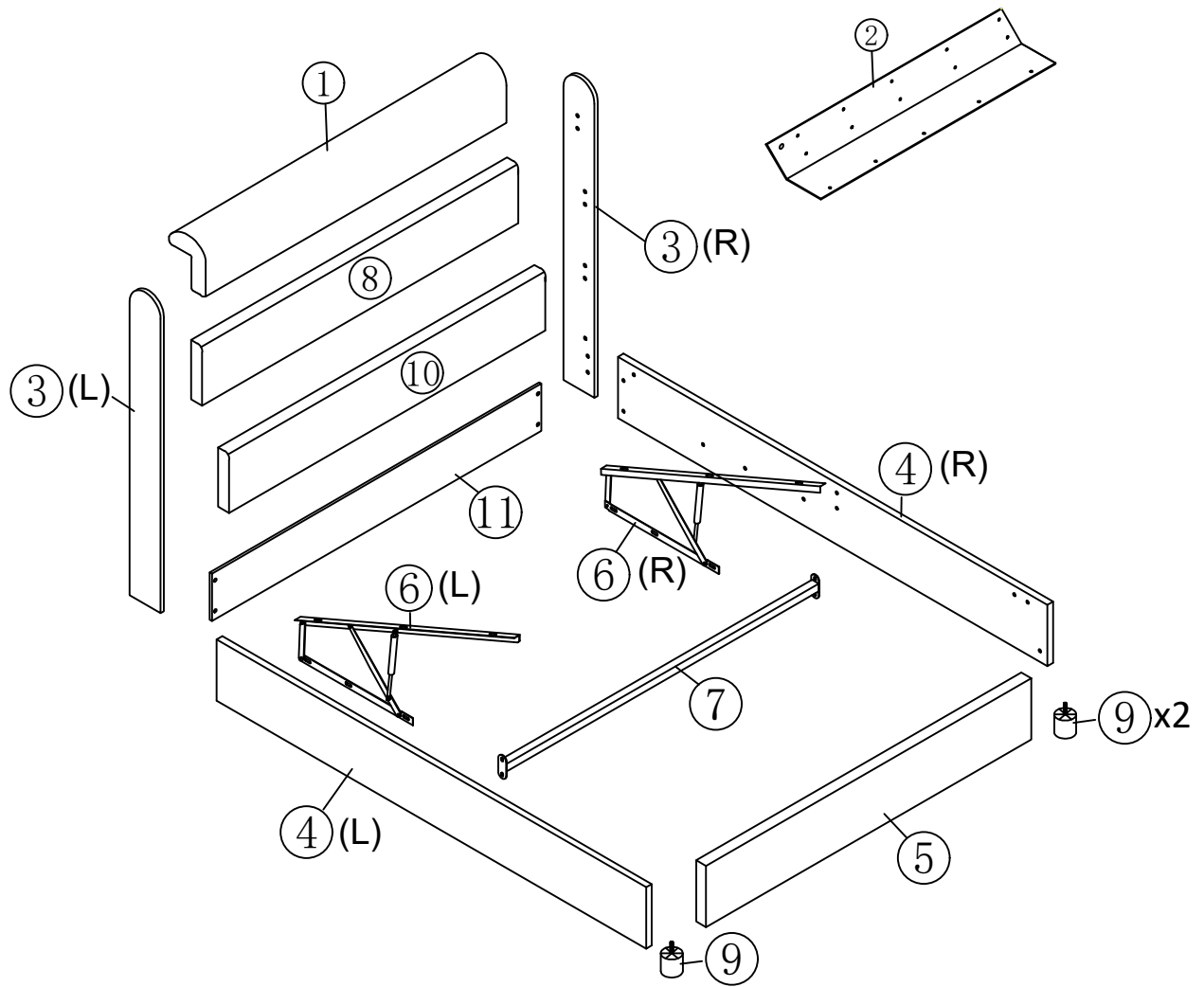

# Detail View

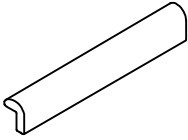
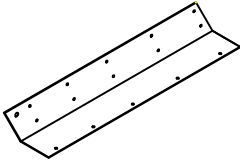

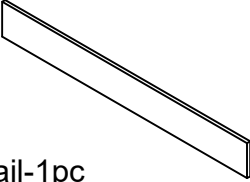
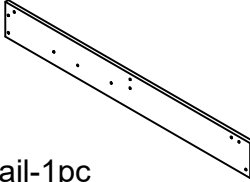
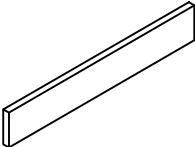

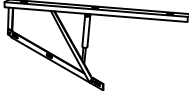
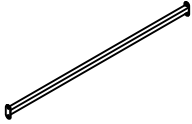
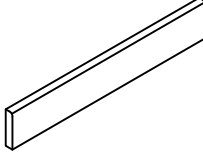

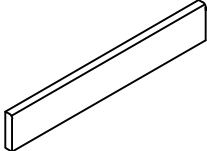
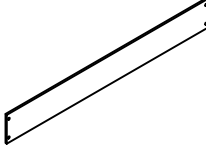
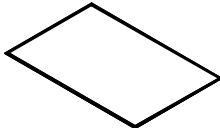
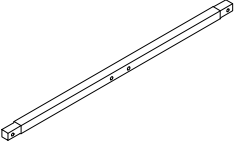
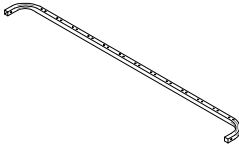
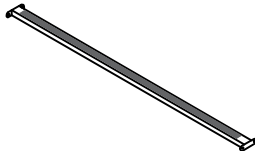
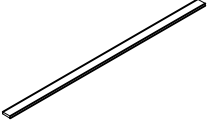







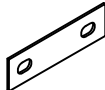





# Part List

N701P170824

<p><b>1</b></p>  <p>Top headboard-1pc</p>	<p><b>2</b></p>  <p>Back board-1pc</p>	<p><b>3L</b></p>  <p>Side board-1pc</p>
<p><b>3R</b></p>  <p>Side board-1pc</p>	<p><b>4L</b></p>  <p>Side rail-1pc</p>	<p><b>4R</b></p>  <p>Side rail-1pc</p>
<p><b>5</b></p>  <p>Foot board-1pc</p>	<p><b>6L</b></p>  <p>Gas lift -1pc</p>	<p><b>6R</b></p>  <p>Gas lift -1pc</p>
<p><b>7</b></p>  <p>Cross bar-1pc</p>	<p><b>8</b></p>  <p>Middle headboard-1pc</p>	<p><b>9</b></p>  <p>Bed legs-2pcs</p>
<p><b>10</b></p>  <p>Below board-1pc</p>	<p><b>11</b></p>  <p>Cross board-1pc</p>	<p><b>12</b></p>  <p>Non woven fabric -1pc</p>
<p><b>13</b></p>  <p>Metal frame cross bar-2pcs</p>	<p><b>14</b></p>  <p>Metal frame side bar-2pcs</p>	<p><b>15</b></p>  <p>Metal frame middle bar-1pc</p>
<p><b>16</b></p>  <p>Slat-12pcs</p>		















# Hardware List

## N701P170824

<b>A</b>  20*70mm	<b>B</b>  Ø8*45mm	<b>C</b> 
Allen Key(1pc)	Bolts(14pcs)	Two hole iron(2pcs)
<b>D</b>  Ø8*18mm	<b>E</b>  Ø8*12mm	<b>F</b> 
Bolts(52pcs)	Bolts(16pcs)	Little "7" Connector(2pcs)
<b>G</b> 	<b>H</b>  77*33**33*3mm	<b>I</b> 
Metal Corner(2pcs)	"7" Connector(9pcs)	Nuts(4pcs)
<b>J</b> 	<b>K</b>  M8	<b>L</b> 
Spanner(1pc)	Nuts(14pcs)	Hinge(2pcs)
<b>M</b> 	<b>N</b> 	<b>O</b>  Ø4*20mm
End slats cap(24pcs)	Stopper(1pc)	Nails(15pcs)
<b>P</b> 	<b>Q</b> 	<b>R</b> 
LED(2pcs)	Power adapter(1pc)	Color controller(1pc)
<b>S</b>  Remote control(1pc)		







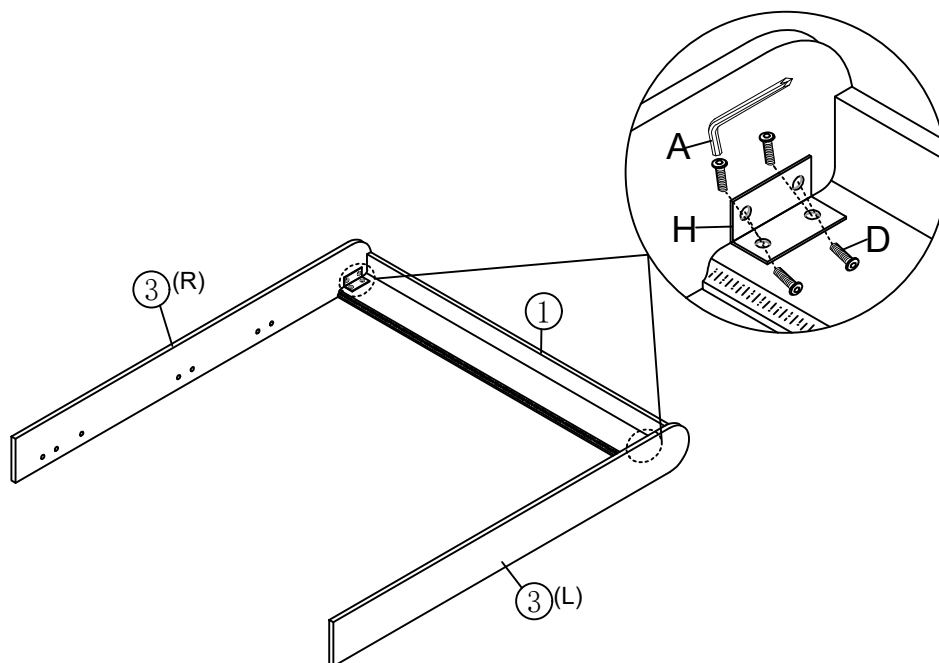













Remark: We recommend you assemble your bed in the flat ground.

### Step 1

<table border="1"> <tr> <td data-bbox="895 239 1086 286">A</td> <td data-bbox="895 286 1086 385">  </td> </tr> <tr> <td data-bbox="1086 239 1286 385"> <table border="1"> <tr> <td data-bbox="1086 239 1286 286">D</td> <td data-bbox="1086 286 1286 385">   M8X18mm  8PCS </td> </tr> </table> </td> <td data-bbox="1286 239 1473 385"> <table border="1"> <tr> <td data-bbox="1286 239 1473 286">H</td> <td data-bbox="1286 286 1473 385">   2PCS </td> </tr> </table> </td> </tr> </table>	A		<table border="1"> <tr> <td data-bbox="1086 239 1286 286">D</td> <td data-bbox="1086 286 1286 385">   M8X18mm  8PCS </td> </tr> </table>	D	 M8X18mm 8PCS	<table border="1"> <tr> <td data-bbox="1286 239 1473 286">H</td> <td data-bbox="1286 286 1473 385">   2PCS </td> </tr> </table>	H	 2PCS
A								
<table border="1"> <tr> <td data-bbox="1086 239 1286 286">D</td> <td data-bbox="1086 286 1286 385">   M8X18mm  8PCS </td> </tr> </table>	D	 M8X18mm 8PCS	<table border="1"> <tr> <td data-bbox="1286 239 1473 286">H</td> <td data-bbox="1286 286 1473 385">   2PCS </td> </tr> </table>	H	 2PCS			
D	 M8X18mm 8PCS							
H	 2PCS							



### Step 2

<table border="1"> <tr> <td data-bbox="699 1209 890 1256">A</td> <td data-bbox="699 1256 890 1352">  </td> </tr> <tr> <td data-bbox="890 1209 1090 1352"> <table border="1"> <tr> <td data-bbox="890 1209 1090 1256">D</td> <td data-bbox="890 1256 1090 1352">   M8X18mm  12PCS </td> </tr> </table> </td> <td data-bbox="1090 1209 1289 1352"> <table border="1"> <tr> <td data-bbox="1090 1209 1289 1256">E</td> <td data-bbox="1090 1256 1289 1352">   M8X12mm  12PCS </td> </tr> </table> </td> <td data-bbox="1289 1209 1473 1352"> <table border="1"> <tr> <td data-bbox="1289 1209 1473 1256">H</td> <td data-bbox="1289 1256 1473 1352">   6PCS </td> </tr> </table> </td> </tr> </table>	A		<table border="1"> <tr> <td data-bbox="890 1209 1090 1256">D</td> <td data-bbox="890 1256 1090 1352">   M8X18mm  12PCS </td> </tr> </table>	D	 M8X18mm 12PCS	<table border="1"> <tr> <td data-bbox="1090 1209 1289 1256">E</td> <td data-bbox="1090 1256 1289 1352">   M8X12mm  12PCS </td> </tr> </table>	E	 M8X12mm 12PCS	<table border="1"> <tr> <td data-bbox="1289 1209 1473 1256">H</td> <td data-bbox="1289 1256 1473 1352">   6PCS </td> </tr> </table>	H	 6PCS
A											
<table border="1"> <tr> <td data-bbox="890 1209 1090 1256">D</td> <td data-bbox="890 1256 1090 1352">   M8X18mm  12PCS </td> </tr> </table>	D	 M8X18mm 12PCS	<table border="1"> <tr> <td data-bbox="1090 1209 1289 1256">E</td> <td data-bbox="1090 1256 1289 1352">   M8X12mm  12PCS </td> </tr> </table>	E	 M8X12mm 12PCS	<table border="1"> <tr> <td data-bbox="1289 1209 1473 1256">H</td> <td data-bbox="1289 1256 1473 1352">   6PCS </td> </tr> </table>	H	 6PCS			
D	 M8X18mm 12PCS										
E	 M8X12mm 12PCS										
H	 6PCS										

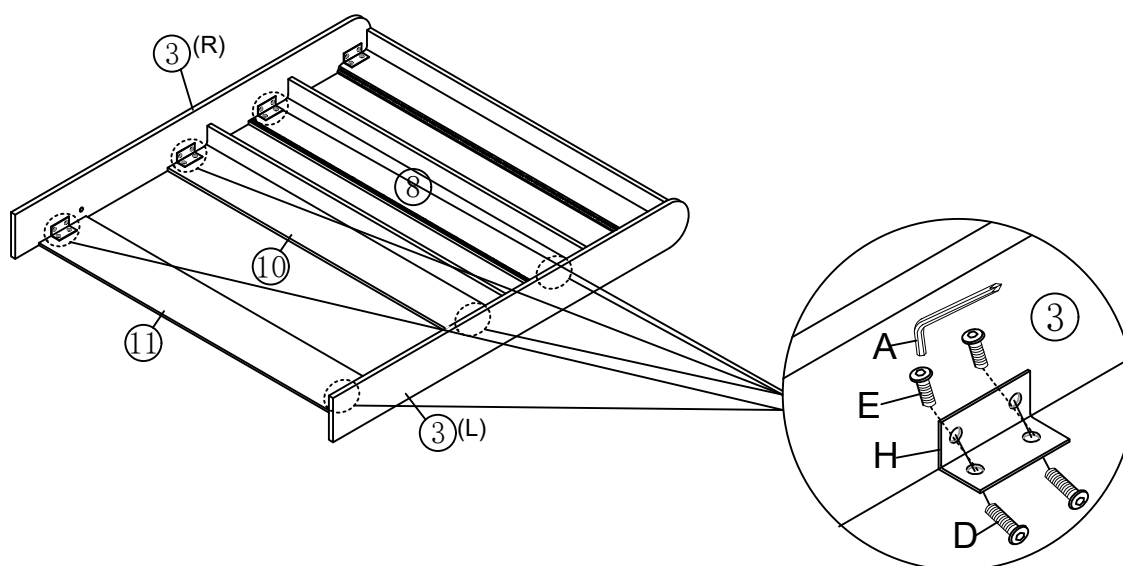

### Step 3

P



2PCS

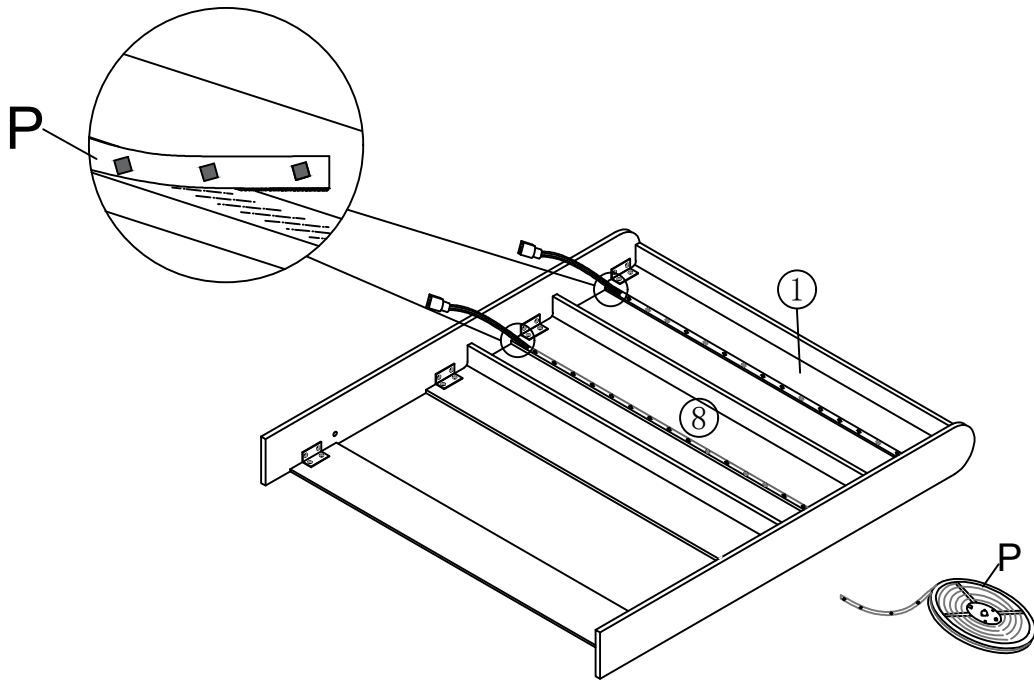

### Step 4

A







O

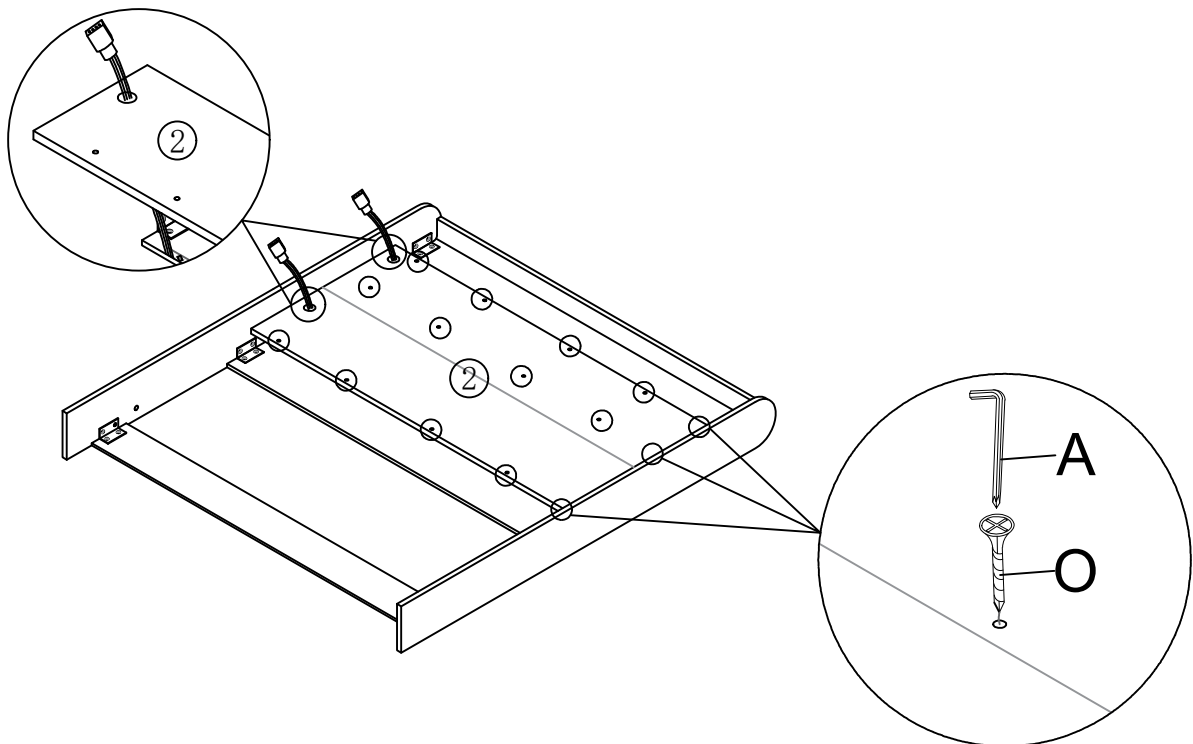

15PCS



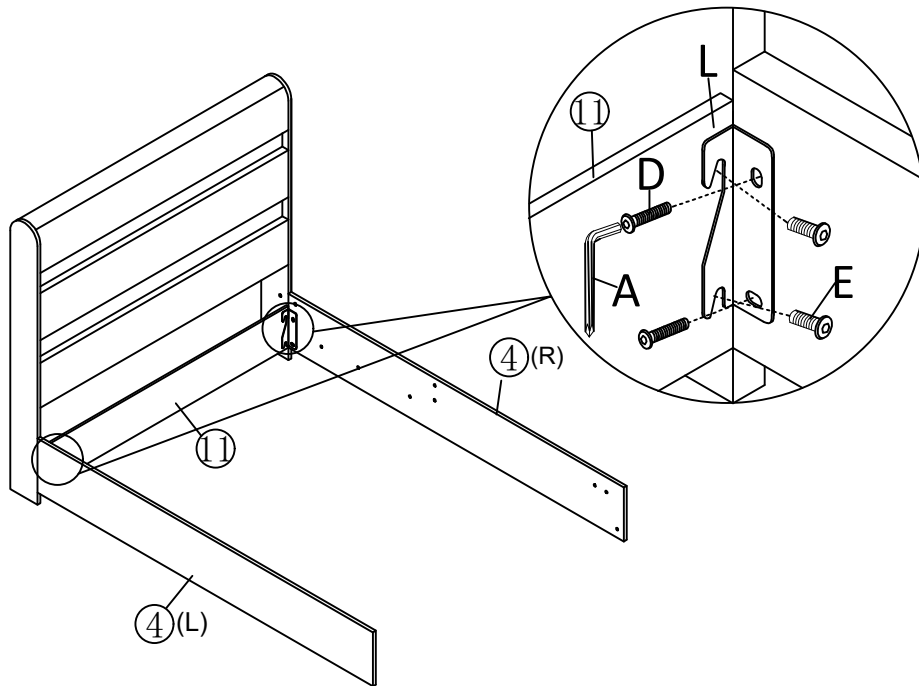

# Step 5

<p>A</p> 	<p>D</p>  <p>M8X18mm</p> <p>4PCS</p>	<p>E</p>  <p>M8X12mm</p> <p>4PCS</p>	<p>L</p>  <p>2PCS</p>
--	--	---	--



# Step 6

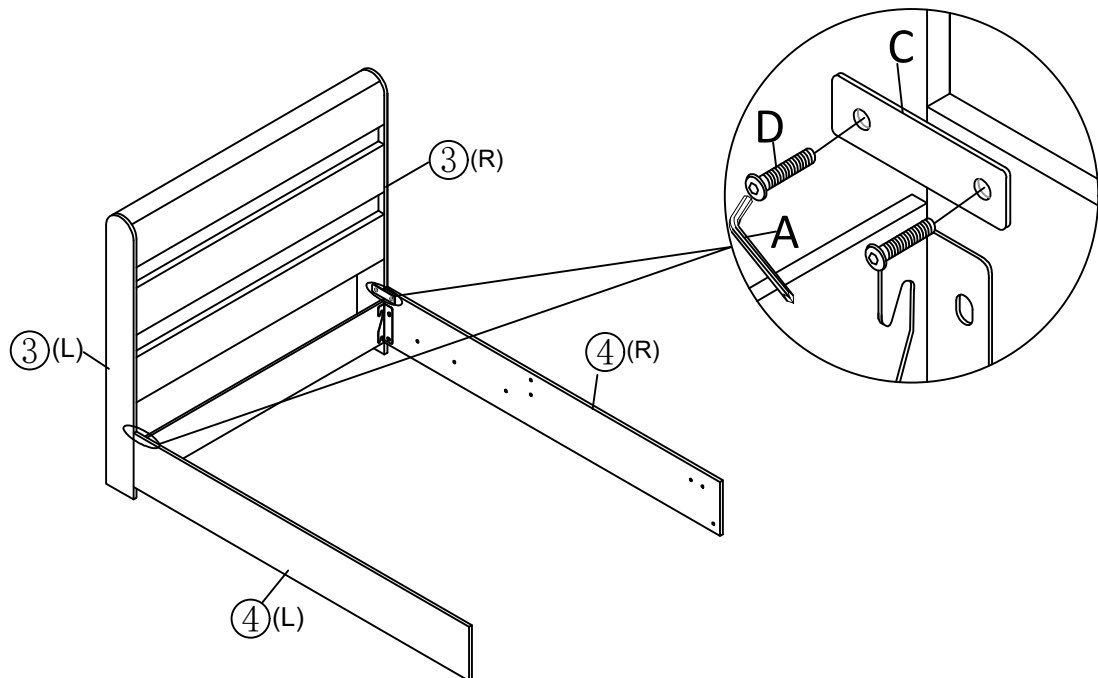

<p>A</p> 	<p>C</p>  <p>2PCS</p>	<p>D</p>  <p>M8X18mm</p> <p>4PCS</p>
---	--	---

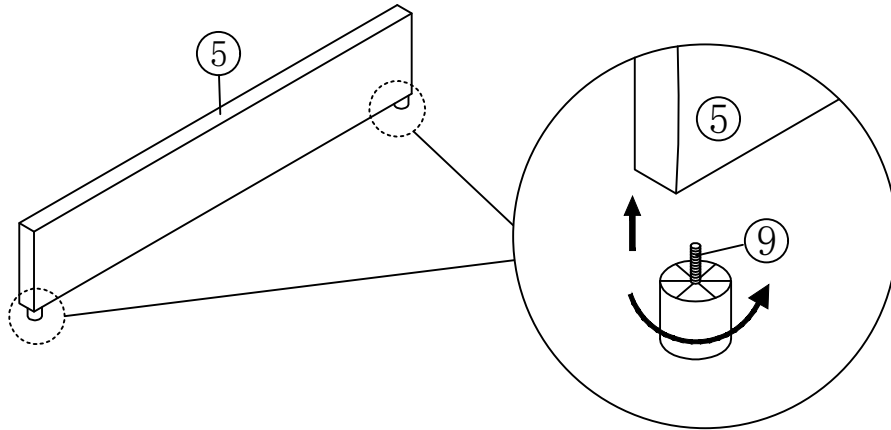

# Step 7



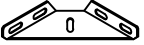

# Step 8

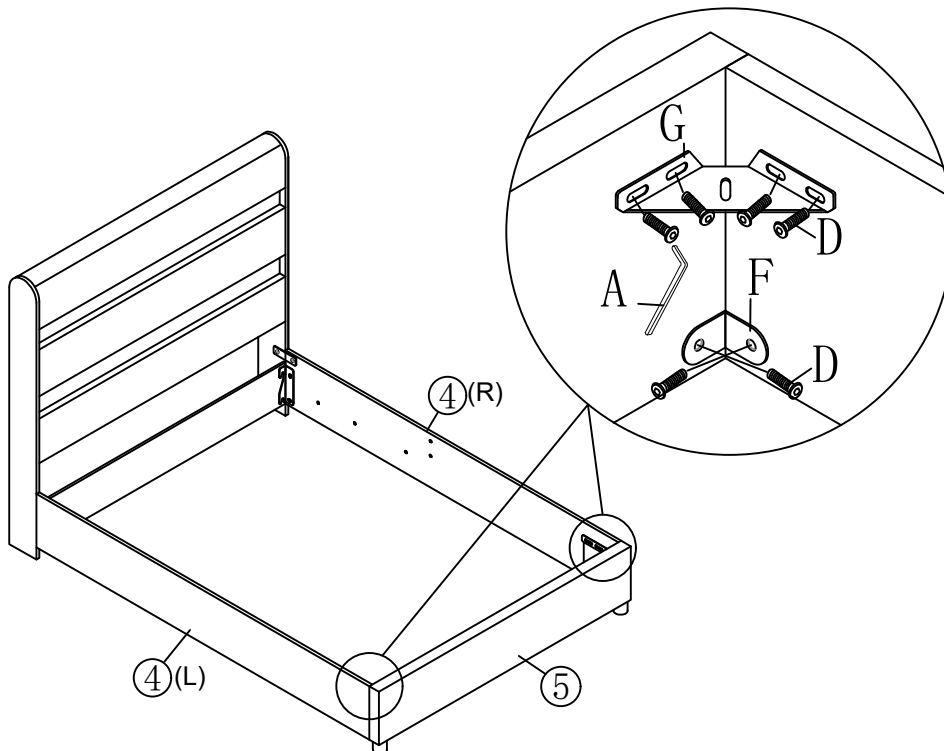
<p>A</p> 	<p>D</p>  <p>M8X18mm</p> <p>12PCS</p>	<p>F</p>  <p>2PCS</p>	<p>G</p>  <p>2PCS</p>
--	---	--	--



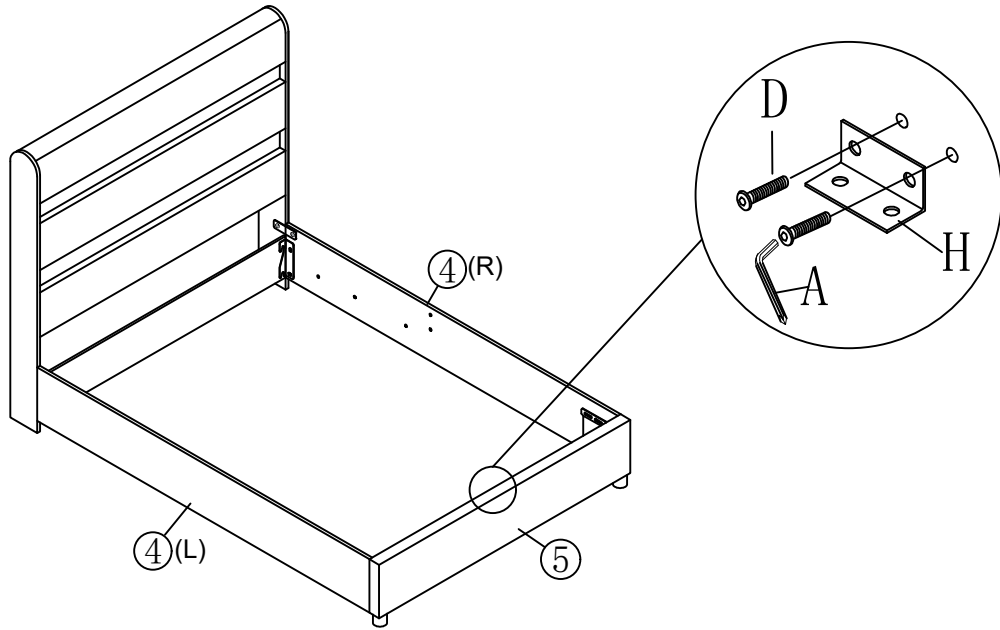

# Step 9

A	D	H
	 M8X18mm	
	2PCS	1PC



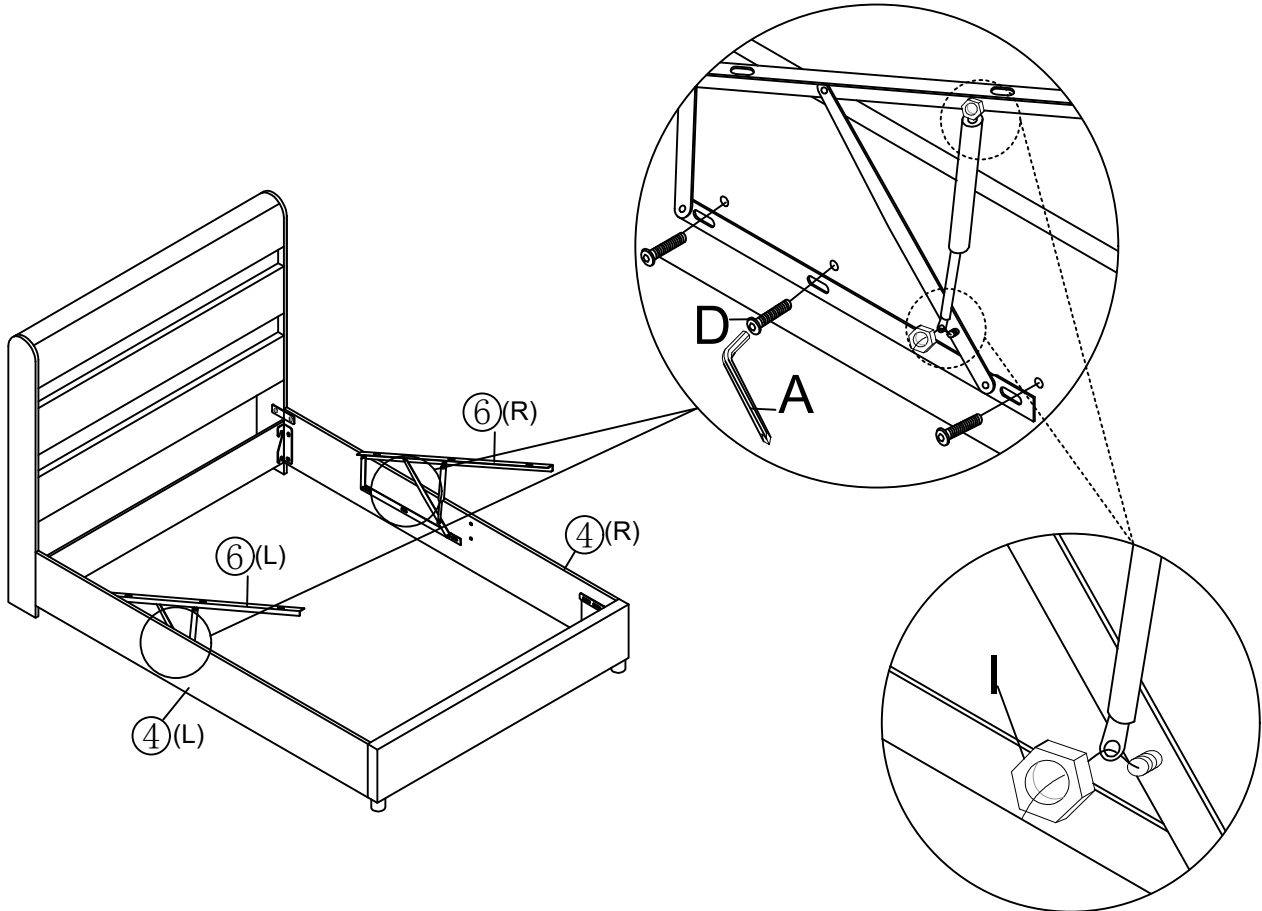

# Step 10

A	D	I
	 M8X18mm	
	6PCS	4PCS



# Step 11



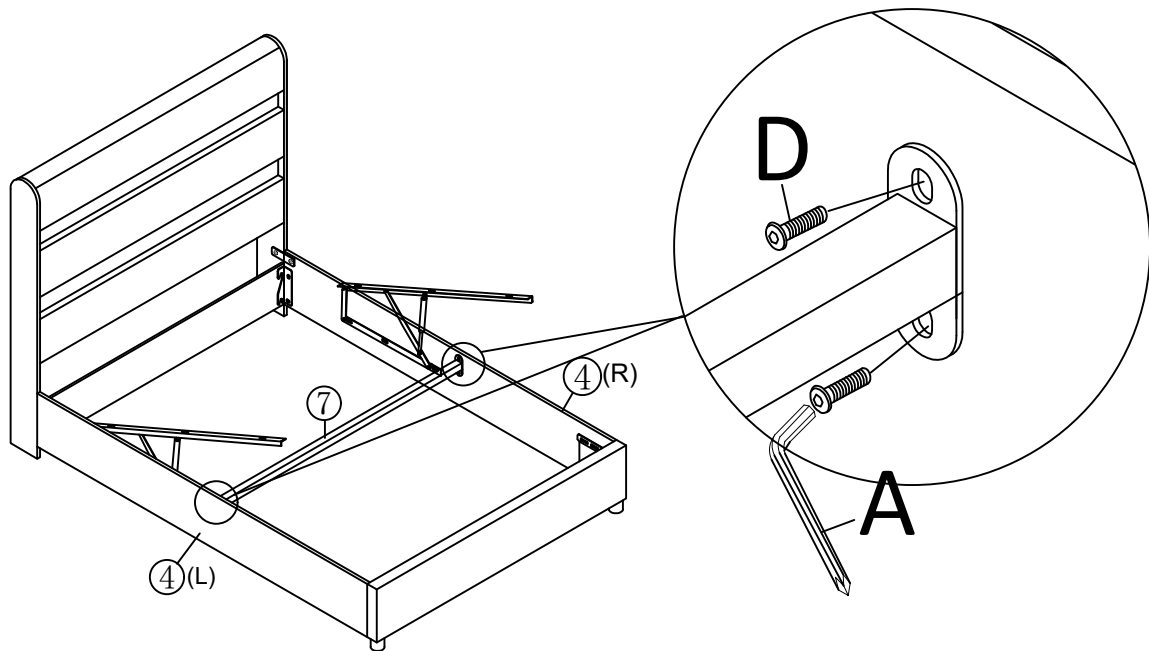

A 	D  M8X18mm 4PCS
--	---

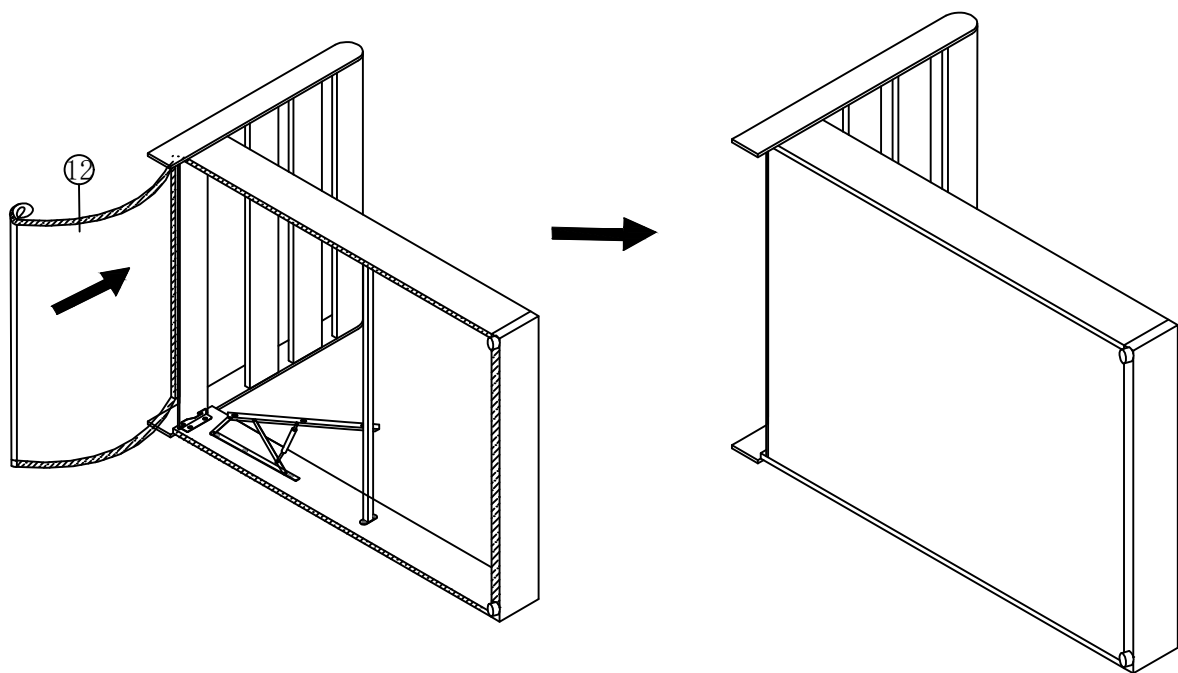

# Step 12



# Step 13

A	B	K	J
	 M8X45mm		
	8PCS	8PCS	1PC

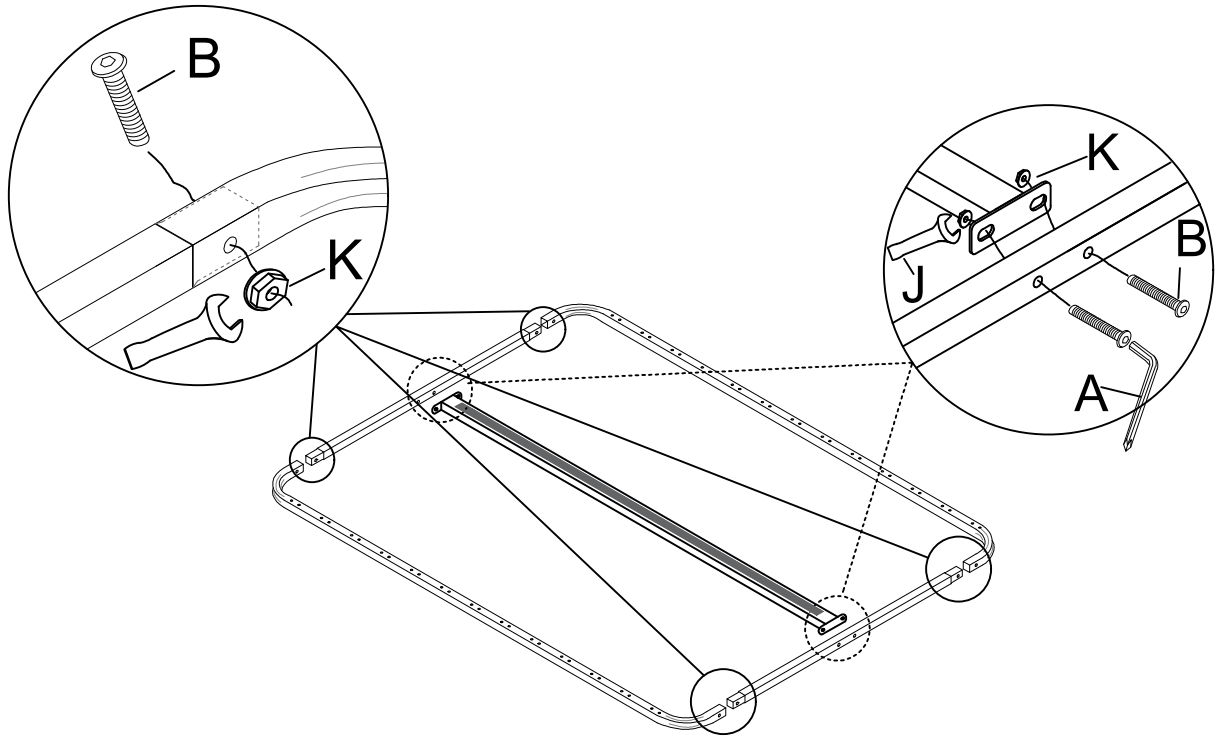



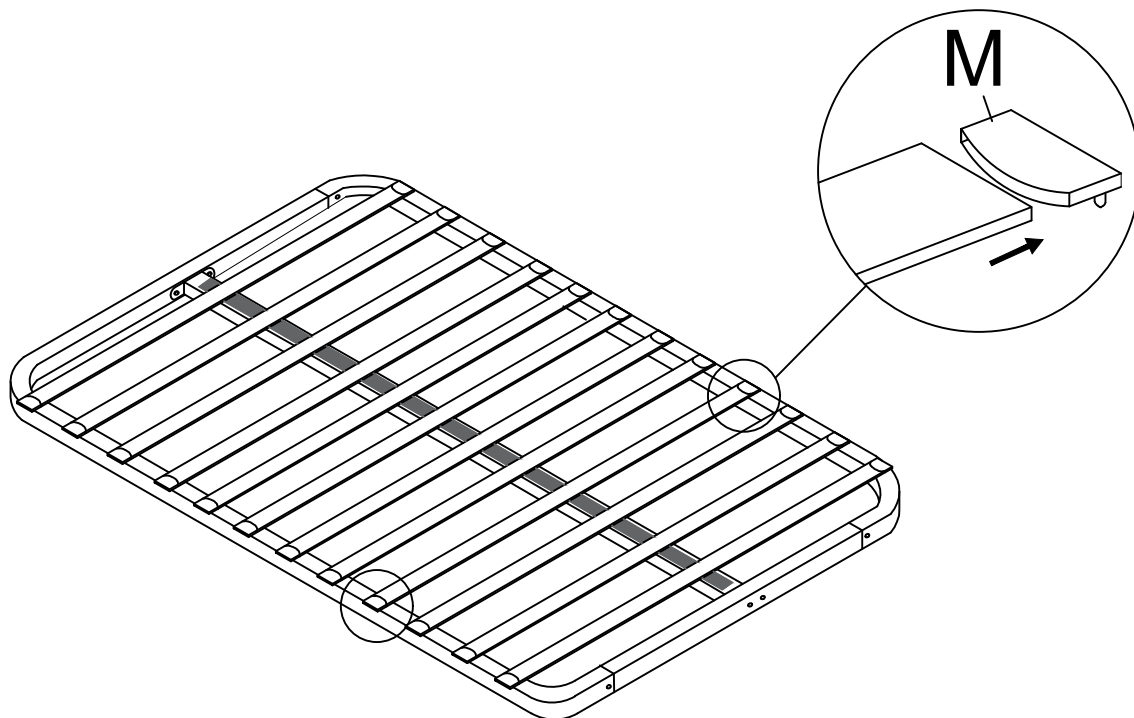

# Step 14

M

24PCS



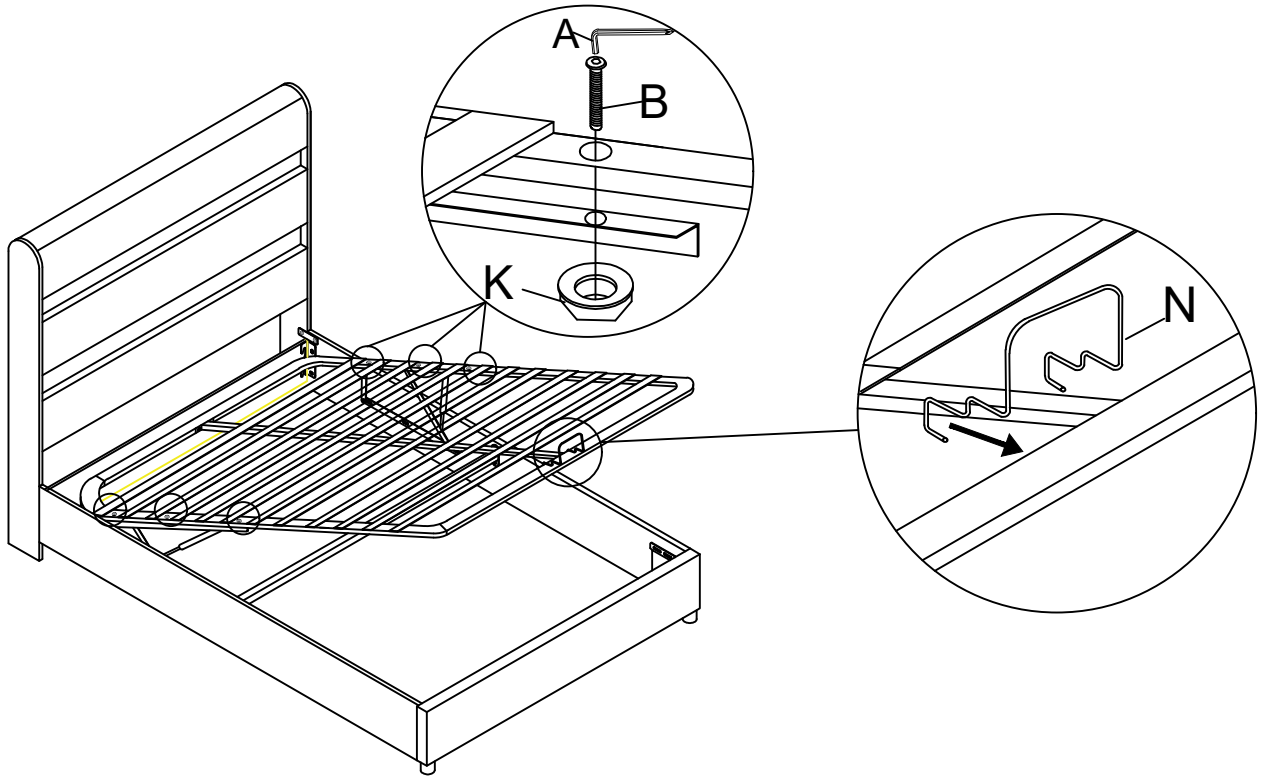

# Step 15

A	B	K	N
	 M8X45mm		
	6PCS	6PCS	1PC



# Step 16

Q	R
	
1PC	1PC

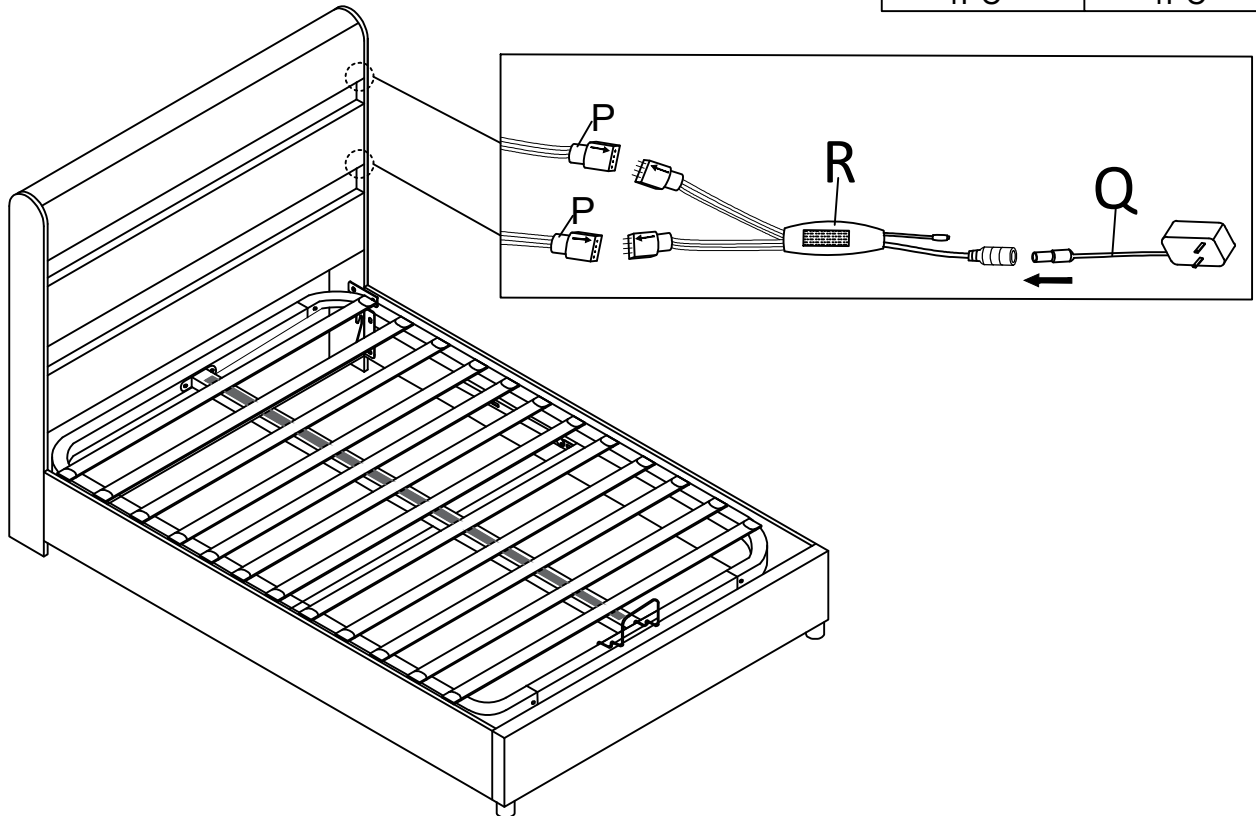

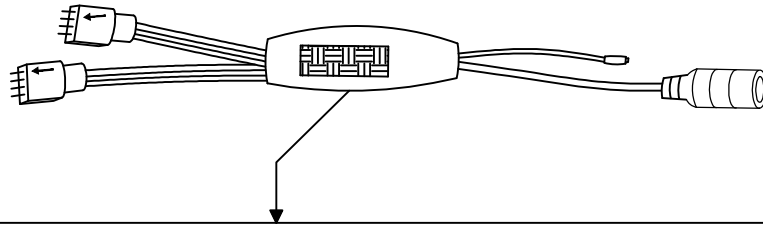

**NOTICE:**

You can scan the QR code here and download an app that can control the color of the light strip like a remote control. When your phone plays music through the app, the color of the light strip will also change according to the strength of the music.

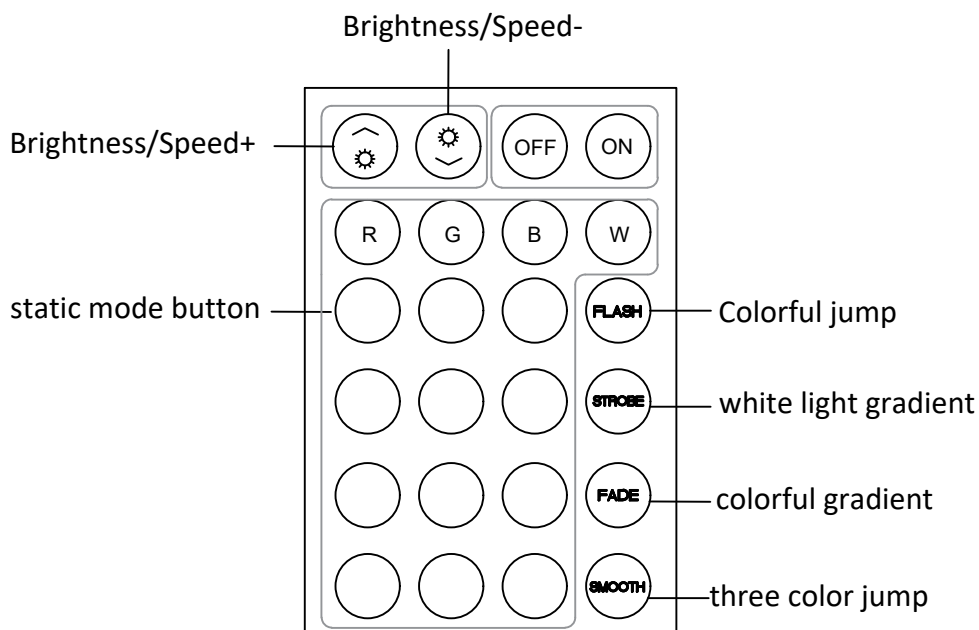

**NOTICE:**

When you use the remote control board to control the color of the light, Please remove the clear plastic card first, then please be sure to point the remote control at the color controller .