

#### STEP 4

Attach Panel (B) to Panel (C) and tighten it using Screw (1).

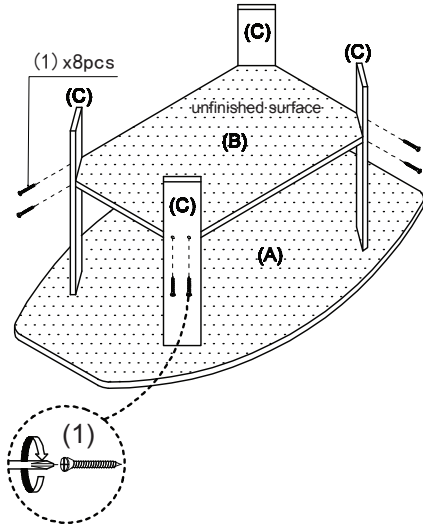

#### STEP 5

Install Nail Leg (3) to the bottom of Panel (C) using hammer, as shown.

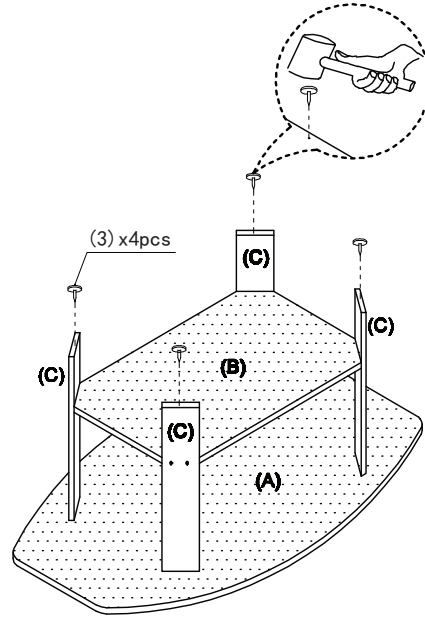

## Assembly Instruction

Simple Design Coffee Table

00:15

Approx. 15 minutes



Recomm. 1 Person

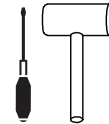

Tools Required

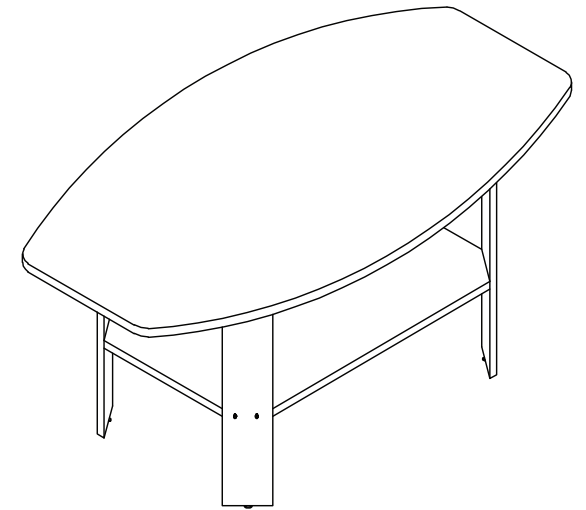

#### Recommended Maximum Weight

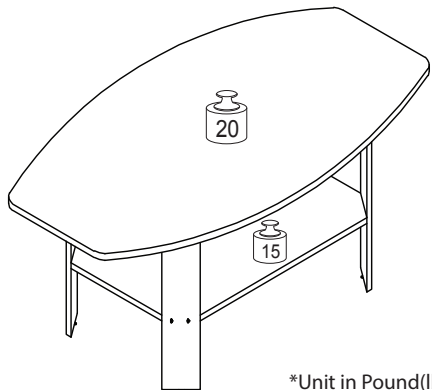





\*Unit in Pound(lbs)



#### **WARNING:**

>This unit has been designed to support the maximum loads shown. Exceeding these load limits could cause sagging, instability, product collapse, and/or serious injury.

>DO NOT allow children to climb on unit.

>Put heavier items on lower shelves.

No	Hardware List	Qty
1	Chipboard Screw 	8pcs
2	Dowel 	8pcs
3	Nail Leg 	4pcs
4	Cam-Lock Nut 	4pcs
5	Cam-Lock Screw 	4pcs

No	Parts List	Qty
A	Top Panel 	1pc
B	Shelf Panel 	1pc
C	Leg Panel 	4pcs

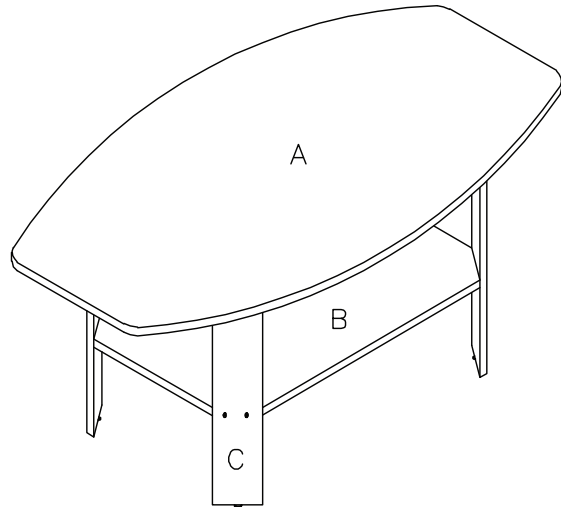

**USEFUL HINTS BEFORE YOU START:**

1. Read each step carefully before starting.
2. It is important that each step is performed in correct order to avoid difficulties.
3. Identify, sort and count the parts before assembly.
4. Assemble your furniture on packaging cardboard to prevent scratch or damage.
5. Clean the product with mild cleanser using soft damped cloth. Do not use harsh or abrasive cleanser.
6. Using incompatible hardware might cause damage to product.

**STEP 1**

Insert Dowel (2) and Cam-Lock Nut (4) to Panel (C).  
NOTE: Arrow on Cam-Lock Nut (4) should be pointing towards hole.

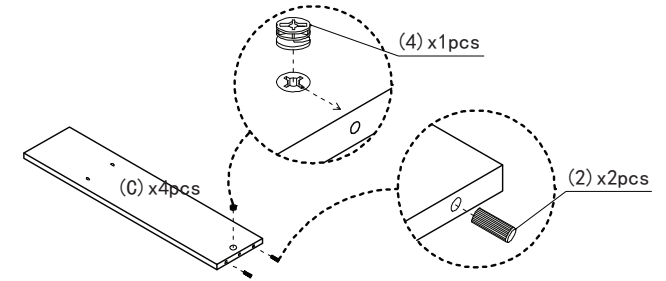

**STEP 2**

Insert Cam-Lock Screw (5) into pre-drilled holes on Panel (A).

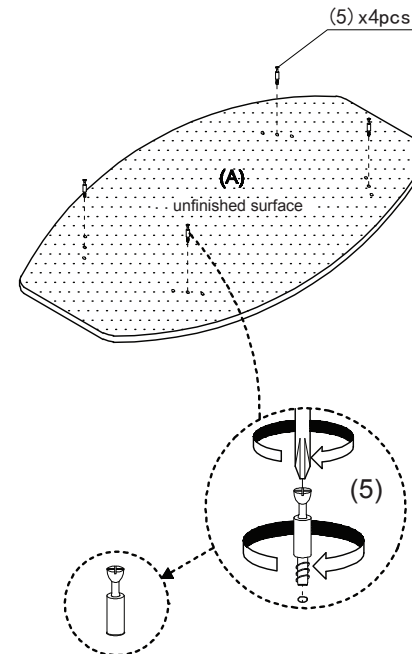

**STEP 3**

Attach Panel (C) to Panel (A) and tighten Cam-Lock Nut (4) using screwdriver.

