

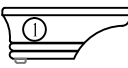

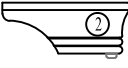

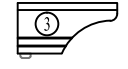
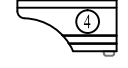

ASSEMBLY INSTRUCTION

DESCRIPTION : 60" TV CONSOLE

Thank you for purchasing this quality product. Be sure to check all packing material carefully for small parts which may have come loose inside the carton during shipment. Identify and count all parts and compare with the parts list below:

Component List			
NO.	Descriptions		Qty.
1	LSF Front Leg (Packed Inside Drawer)		1
2	RSF Front Leg (Packed Inside Drawer)		1
3	LSF Back Leg (Packed Inside Drawer)		1
4	RSF Back Leg (Packed Inside Drawer)		1
5	Center Support Leg (Packed Inside Drawer)		2

6 Assembly Hardware Pack			
NO.	Descriptions		Qty.
A	Screw- M6 x 40MM JCBC Bolt Blk		8
B	Washer - Spring Washer M6		8
C	Washer - Flat Washer 1/4" (BLK)		8
D	Allen Wrench		1

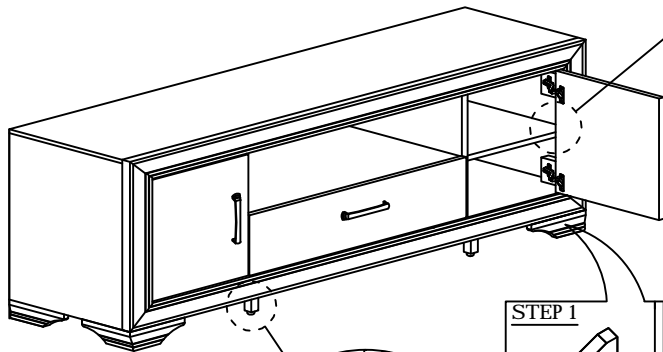
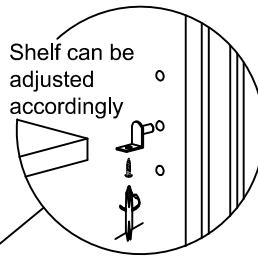
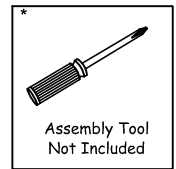

TO REMOVE THE DRAWER:

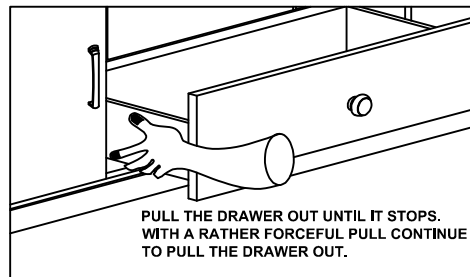

TO INSTALL THE DRAWER:

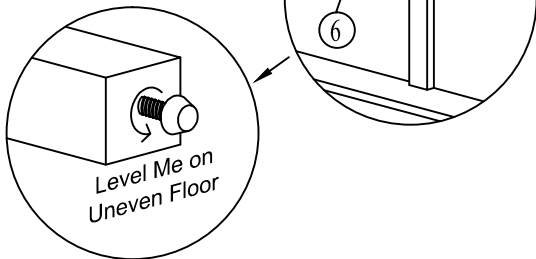
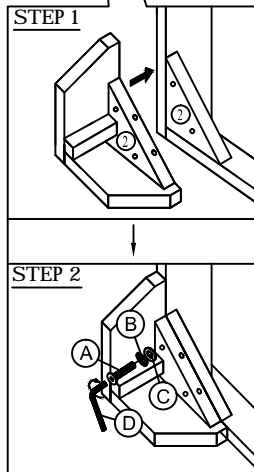
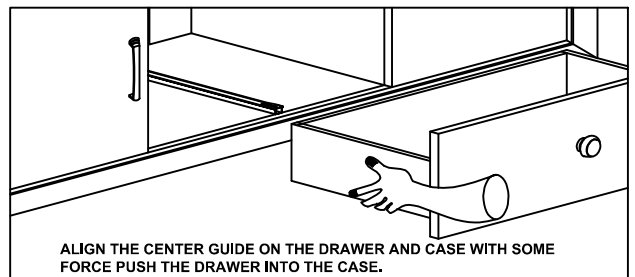

ASSEMBLY TIPS:

1. Remove hardware from box and sort by size.
2. Please check to see that all hardware and parts are present prior start of assembly.
3. Please follow attached instructions in the same sequence as numbered to assure fast and easy assembly.

⚠ WARNING!

1. Don't attempt to repair or modify parts that are broken or defective. Please contact the store immediately.
2. This product is for home use only and not intended for commercial establishments.