















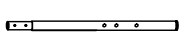

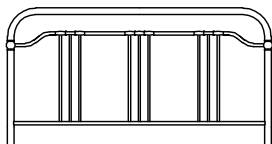
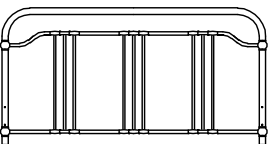







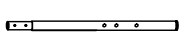

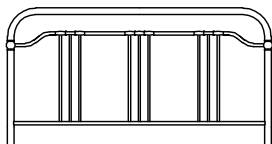
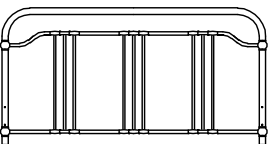

Parts List For Bed

BED CARTON	HEADBOARD CARTON																
<p>(10) HEADBOARD PANEL (11) FOOTBOARD PANEL</p> <p>PART HARDWARE BAG FOR BED ATTACHMENT TO FRAME</p> <p>(1) 1/4-20 X 2 1/4" FLAT ALLEN HEAD SCREW-4 (2) 1/4-20 X 3/4" FLAT ALLEN HEAD SCREW-4 (3) 1/4-20 X 1/2" FLAT ALLEN HEAD SCREW-4 (4) 1/4-20 HEX NUT-4 (5) 1/4" ID X 5/8" OD FLAT WASHER-12 (6) ALLEN WRENCH (7) OPEN WRENCH (8) LEG EXTENSION-2 (9) PLASTIC GLIDE -4</p> <p>NOTE: PLASTIC GLIDES COME PRE-INSTALLED</p>	<p>(10) HEADBOARD PANEL</p> <p>PART HARDWARE BAG FOR HEADBOARD ATTACHMENT TO FRAME</p> <p>(1) 1/4-20 X 2 1/4" FLAT ALLEN HEAD SCREW-4 (3) 1/4-20 X 1/2" FLAT ALLEN HEAD SCREW-4 (4) 1/4-20 HEX NUT-4 (5) 1/4" ID X 5/8" OD FLAT WASHER-8 (6) ALLEN WRENCH (7) OPEN WRENCH (8) LEG EXTENSION-2 (9) PLASTIC GLIDE -2</p> <p>NOTE: PLASTIC GLIDES COME PRE-INSTALLED</p>	<table border="1"> <tr> <td data-bbox="980 302 1101 415">1 </td> <td data-bbox="1105 302 1214 415">2 </td> <td data-bbox="1219 302 1328 415">3 </td> <td data-bbox="1333 302 1442 415">4 </td> <td data-bbox="1446 302 1555 415">5 </td> </tr> <tr> <td data-bbox="980 422 1101 535">6 </td> <td data-bbox="1105 422 1214 535">7 </td> <td data-bbox="1219 422 1442 535">8 </td> <td data-bbox="1446 422 1555 535">9 </td> <td></td> </tr> <tr> <td colspan="2" data-bbox="980 541 1263 724">10 </td> <td colspan="3" data-bbox="1268 541 1550 724">11 </td> </tr> </table>	1 	2 	3 	4 	5 	6 	7 	8 	9 		10 		11 		
1 	2 	3 	4 	5 													
6 	7 	8 	9 														
10 		11 															

SAVE ALL PACKAGING MATERIALS UNTIL PRODUCT IS FULLY ASSEMBLED. HARDWARE AND SMALL PIECES MAY NOT BE SEEN AND COULD BE ACCIDENTALLY DISCARDED WITH PACKAGING MATERIALS.

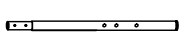
PRODUCT FULLY ASSEMBLED

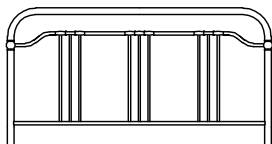
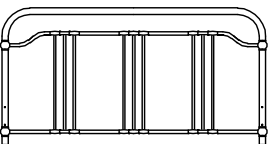
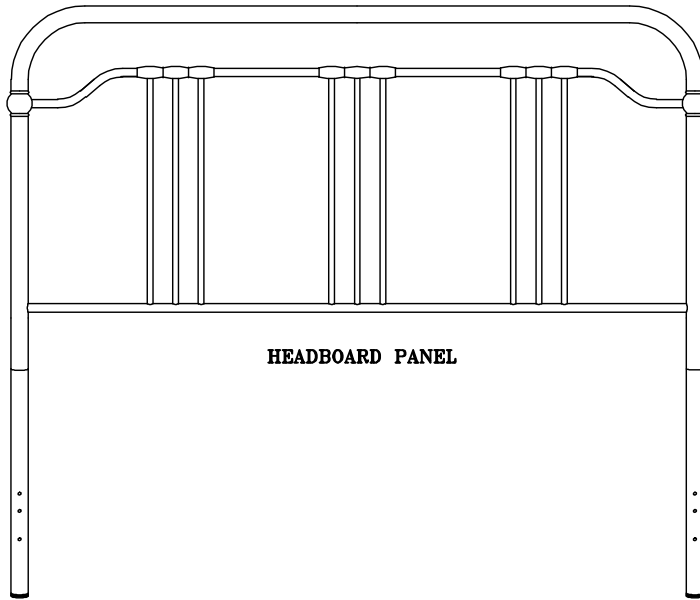

HEADBOARD PANEL

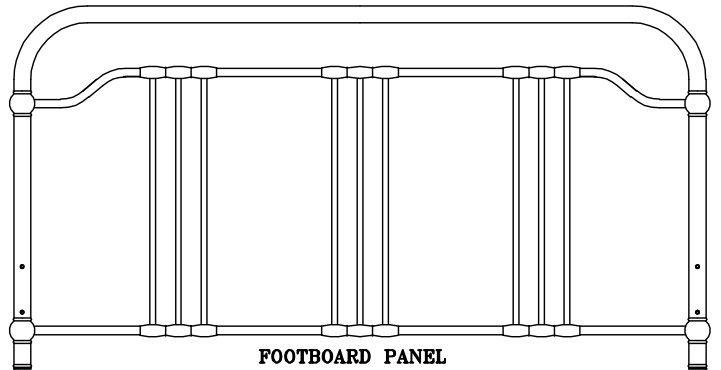

FOOTBOARD PANEL

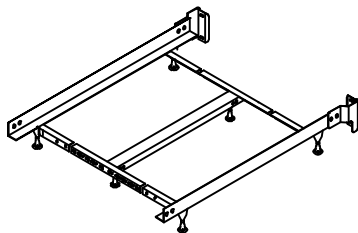

QUEEN - KING HEADBOARD ONLY FRAME FULLY ASSEMBLED FRAMES
NOTE: SEE INSTRUCTIONS INCLUDED IN FRAME CARTON FOR FRAME ASSEMBLY

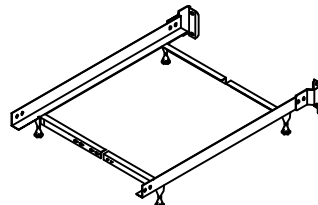

TWIN - FULL HEADBOARD ONLY FRAME FULLY ASSEMBLED
NOTE: SEE INSTRUCTIONS INCLUDED IN FRAME CARTON FOR FRAME ASSEMBLY

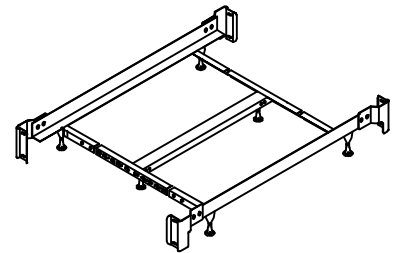

QUEEN - KING BED FRAME FULLY ASSEMBLED
NOTE: SEE INSTRUCTIONS INCLUDED IN FRAME CARTON FOR FRAME ASSEMBLY

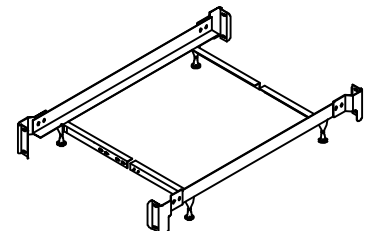

TWIN - FULL BED FRAME FULLY ASSEMBLED
NOTE: SEE INSTRUCTIONS INCLUDED IN FRAME CARTON FOR FRAME ASSEMBLY

FIGURE 1

Instruction Sheet

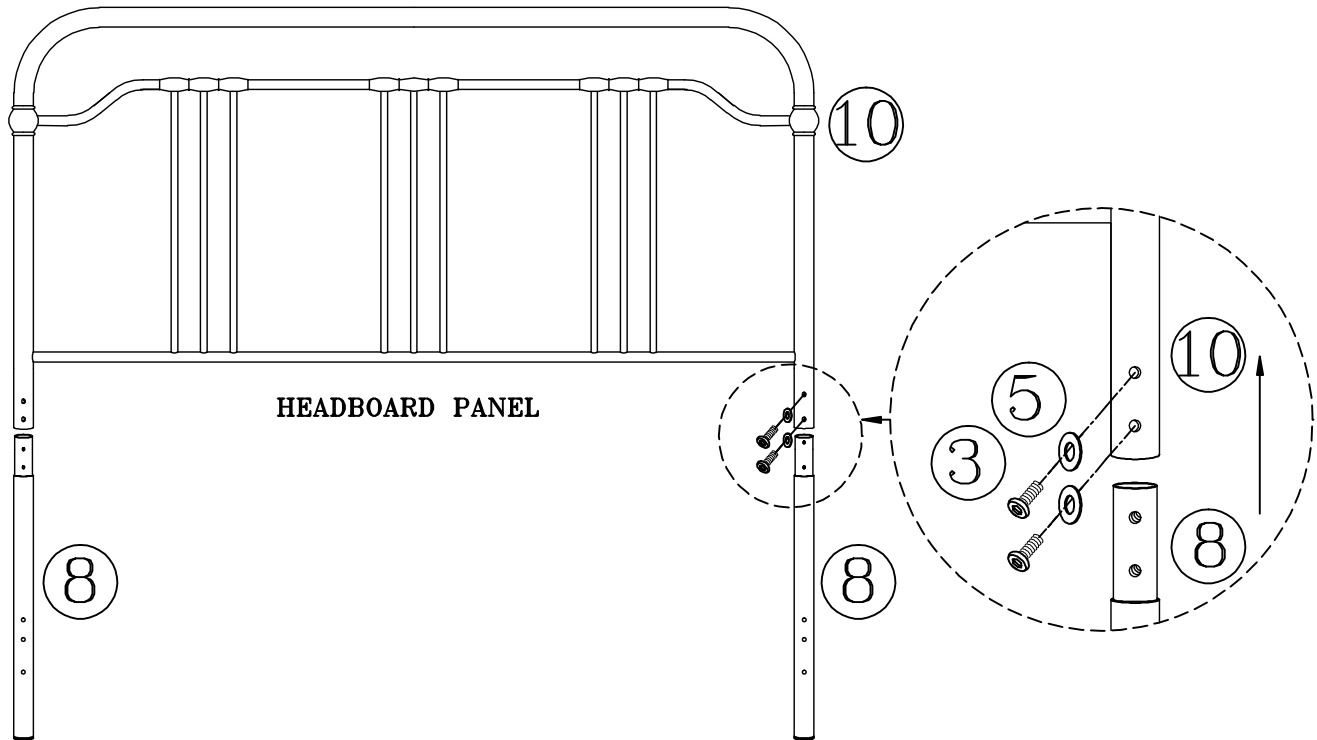
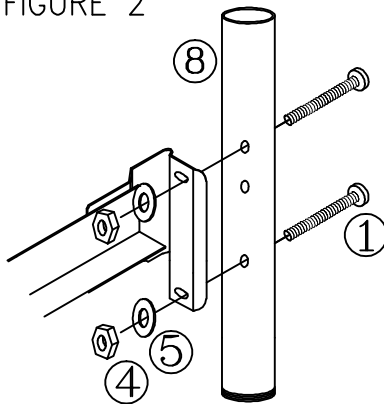

FIGURE 2



Step 1 Leg Extension Assembly

- Align top reduction of extension leg (8) with bottom of panel post (10). (See Figure 1)
- Now carefully insert extension leg (8) into bottom of panel (10) post.
- Secure leg extension (8) with screws (3) and flat washer (5) to panel (10).
- Tighten screws with Allen wrench (6).
- Repeat on other side of headboard panel.

Step 2 Headboard Assembly

- Place headboard and frame in desired location in room.
- Place 2 screws (1) through holes located in leg (8). (See Figure 2)
- Align bed frame bracket over screws.
- Place a flat washer (5) first and then a nut (4) on each screw. DO NOT TIGHTEN SCREWS COMPLETELY.
- Repeat on other side of headboard.
- Tighten all screws securely using the Allen wrench (6) and open wrench (7).

FIGURE 3

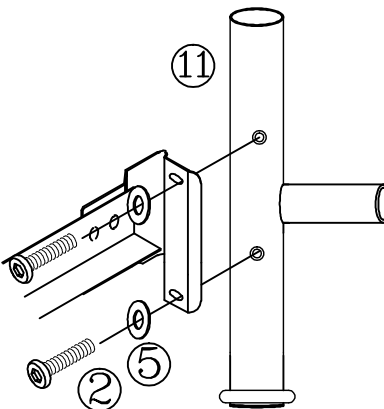

Step 3 Footboard Assembly

- Position footboard panel and align holes in the post (11) with holes in the frame bracket. (See figure 3)
- Place flat washer (5) on each screw (2). Insert through bracket and into post.
DO NOT TIGHTEN SCREWS COMPLETELY.
- Repeat on other side of footboard panel.
- Tighten all screws securely using the Allen wrench (6).

FOR ASSISTANCE IN ASSEMBLY ONLY OF THIS PRODUCT. CALL OUR HELP DESK. PLEASE HAVE THE STYLE NUMBER AVAILABLE BEFORE YOU CALL. (STYLE # OR NAME CAN BE FOUND ON PACKING CARTON OR SALES RECEIPT.) OUR PRODUCT IS INSPECTED TO ENSURE IT IS IN GOOD CONDITION. IF YOUR FURNITURE APPEARS TO HAVE BEEN DAMAGED IN SHIPMENT OR YOU ARE IN NEED OF REPLACEMENT PARTS PLEASE CONTACT THE DEALER FROM WHOM YOU PURCHASED THE PRODUCT.