

Bookcase

Instruction Manual

Estantería

Manual de instrucciones

Bibliothèque

Manuel d'instructions

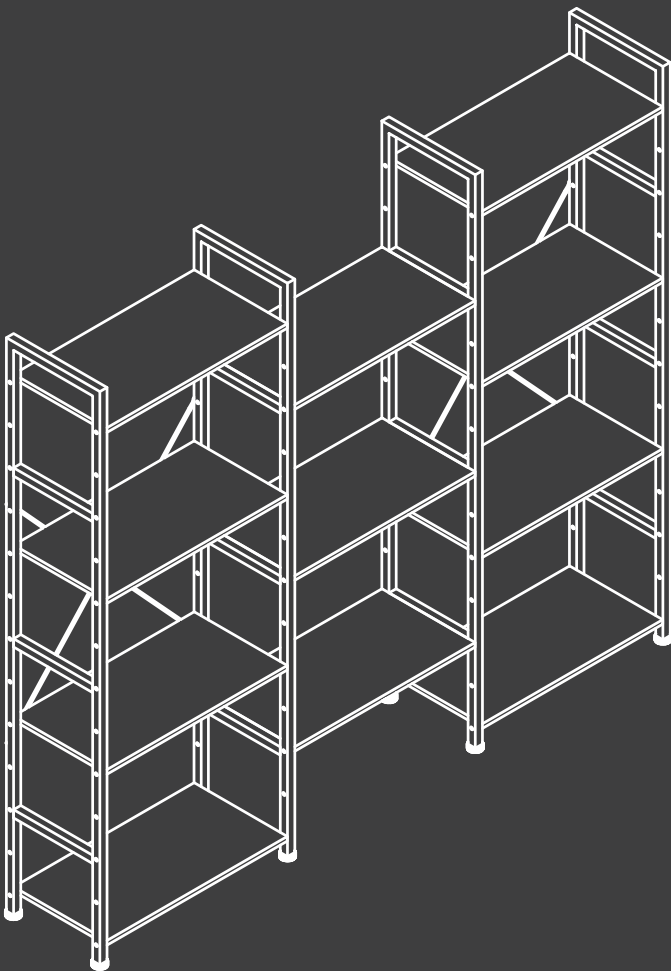

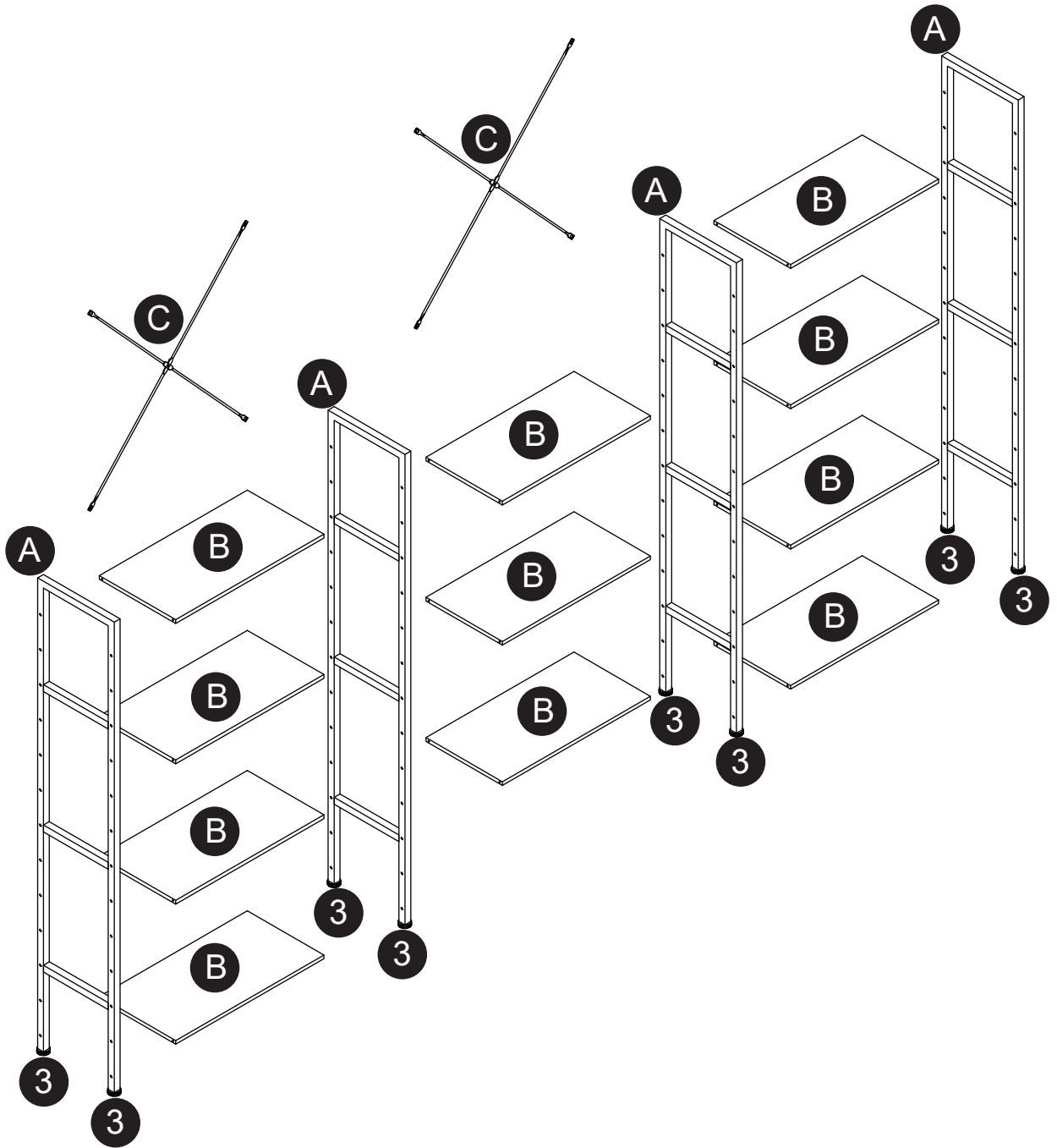

A X4

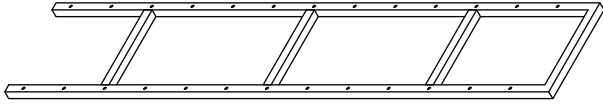

B X11

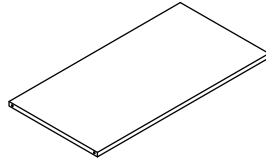

C X2

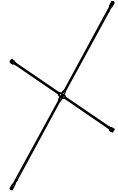

1 X44

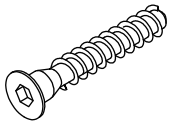

M6*50mm

2 X8

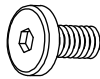

M6*10mm

3 X8

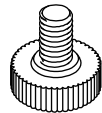

4 X1

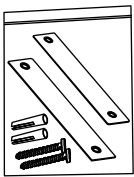

5 X1



Step 1

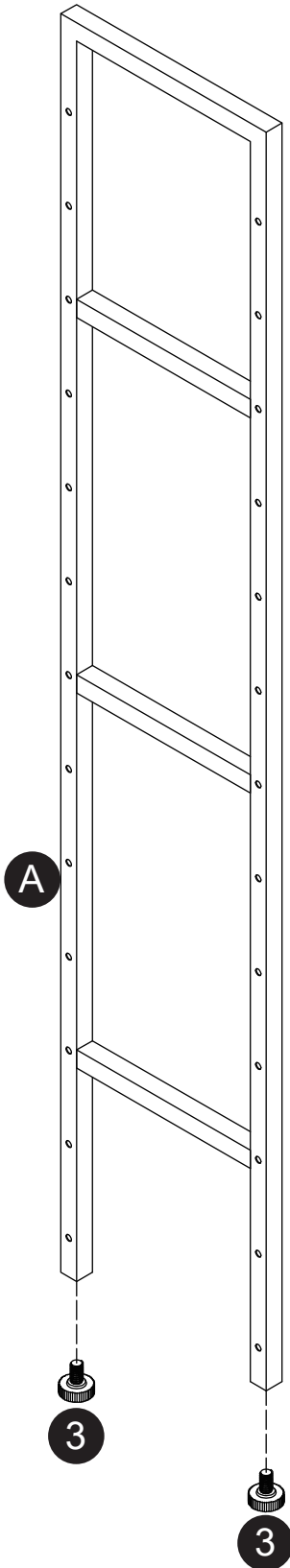
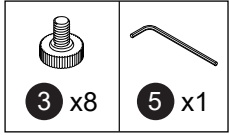

X4

Step 2

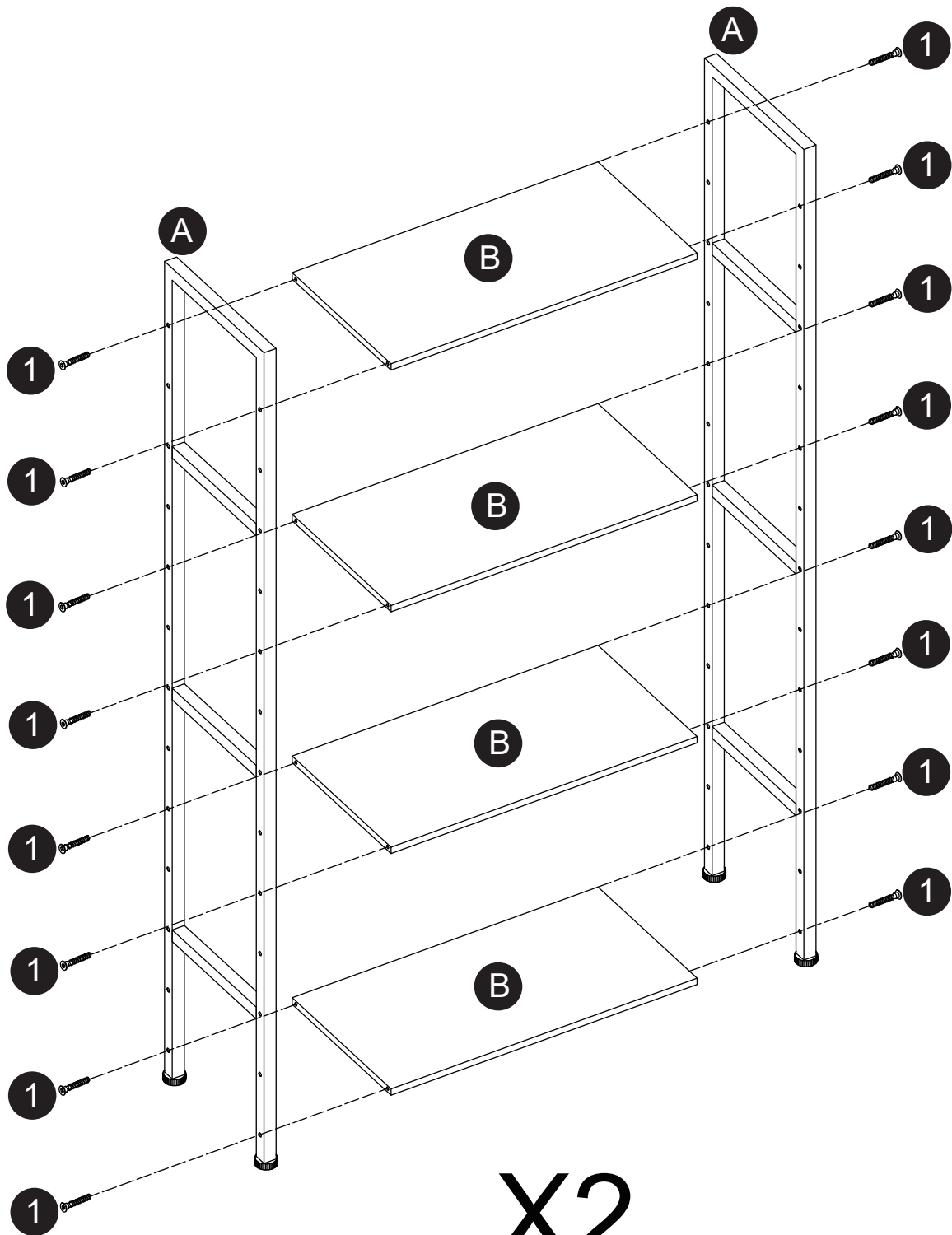
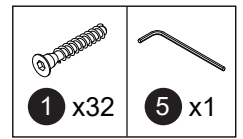

X2

Step 3

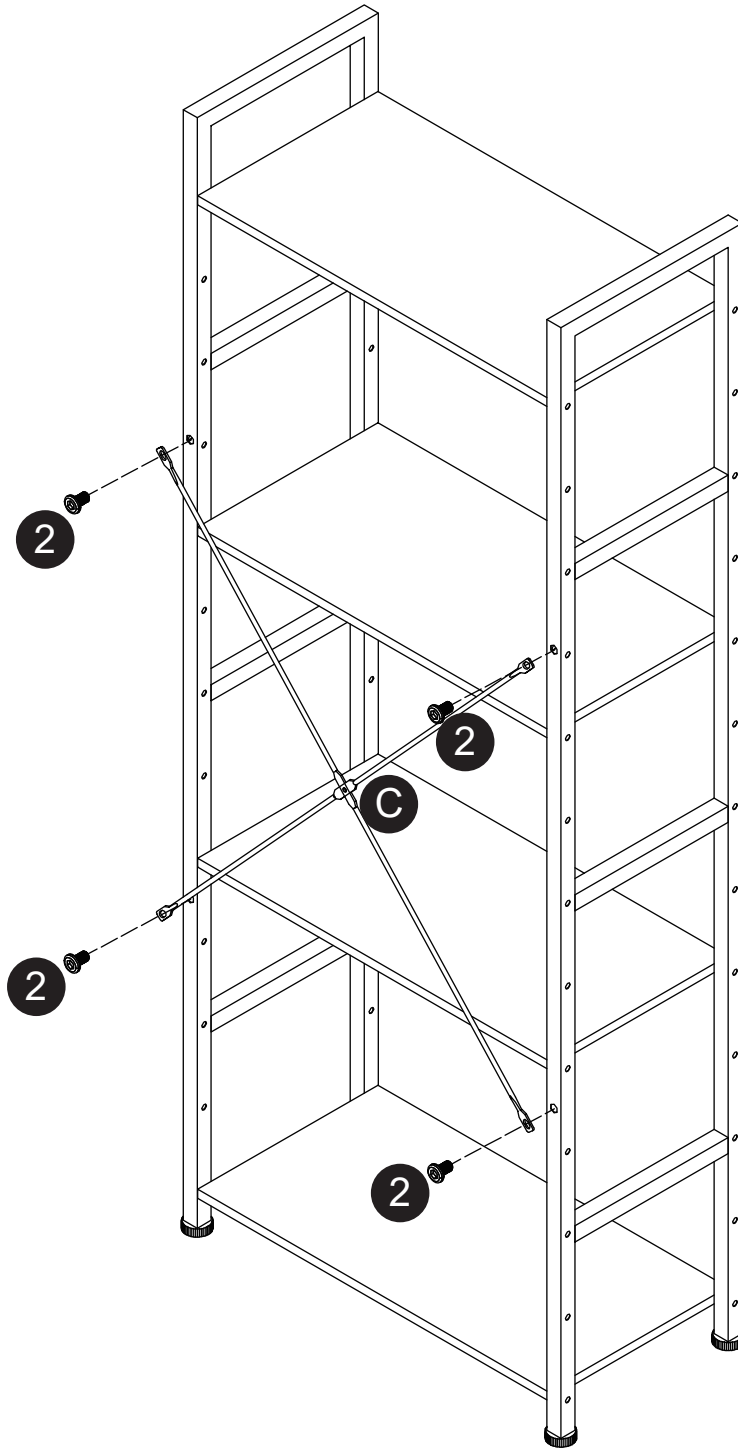
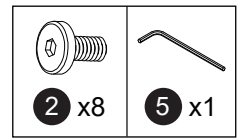

X2

Step 4

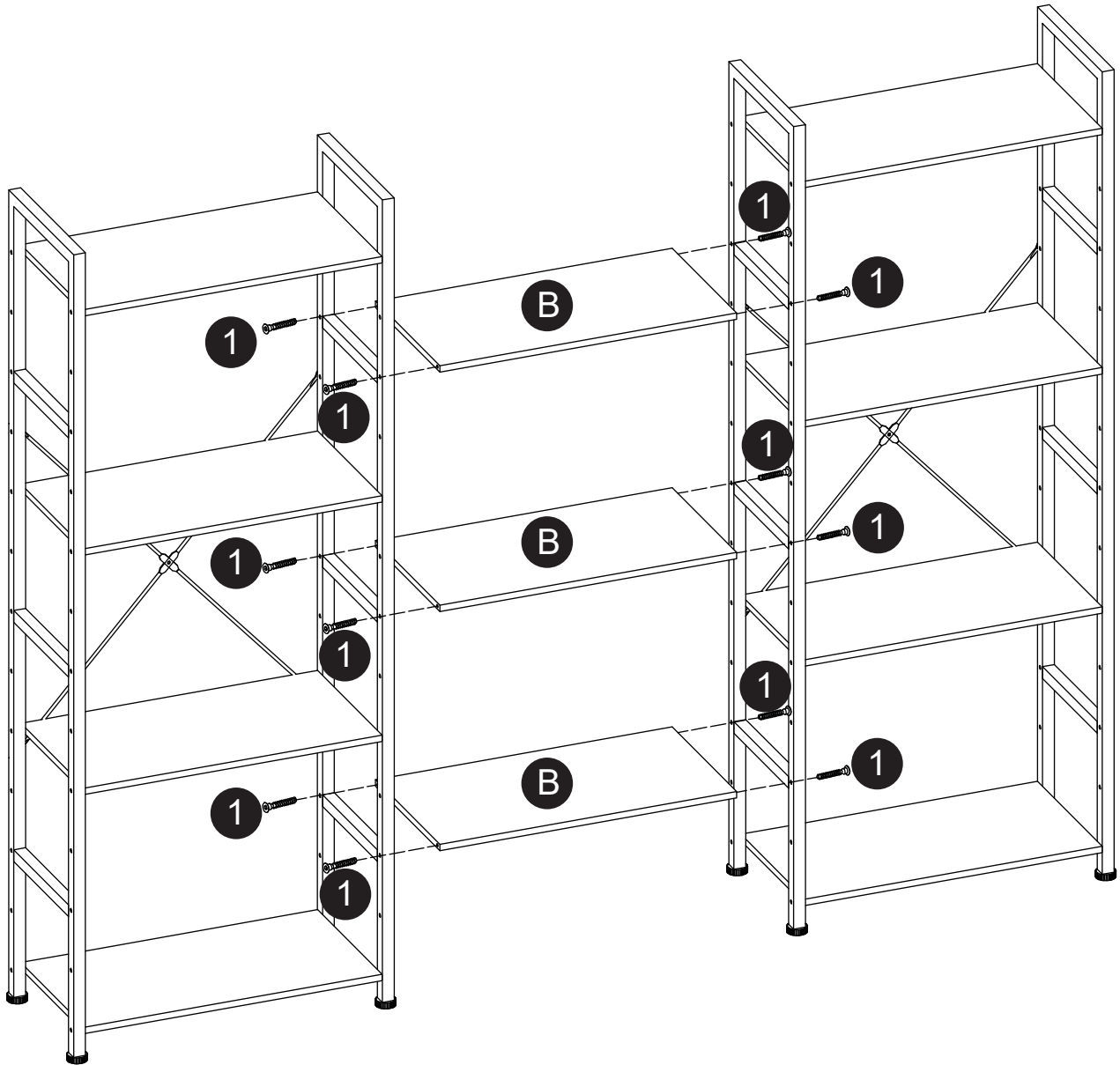
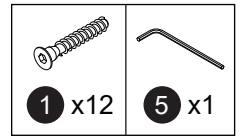

Step 5

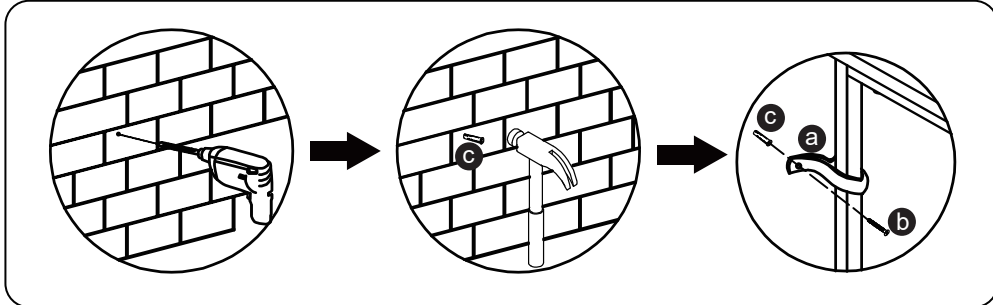
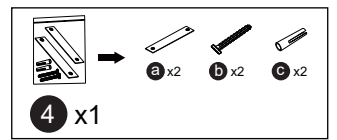

EN: **Note:** Tools are not provided.

ES: **Nota:** No se incluyen herramientas.

FR: **Remarque :** Les outils ne sont pas fournis.

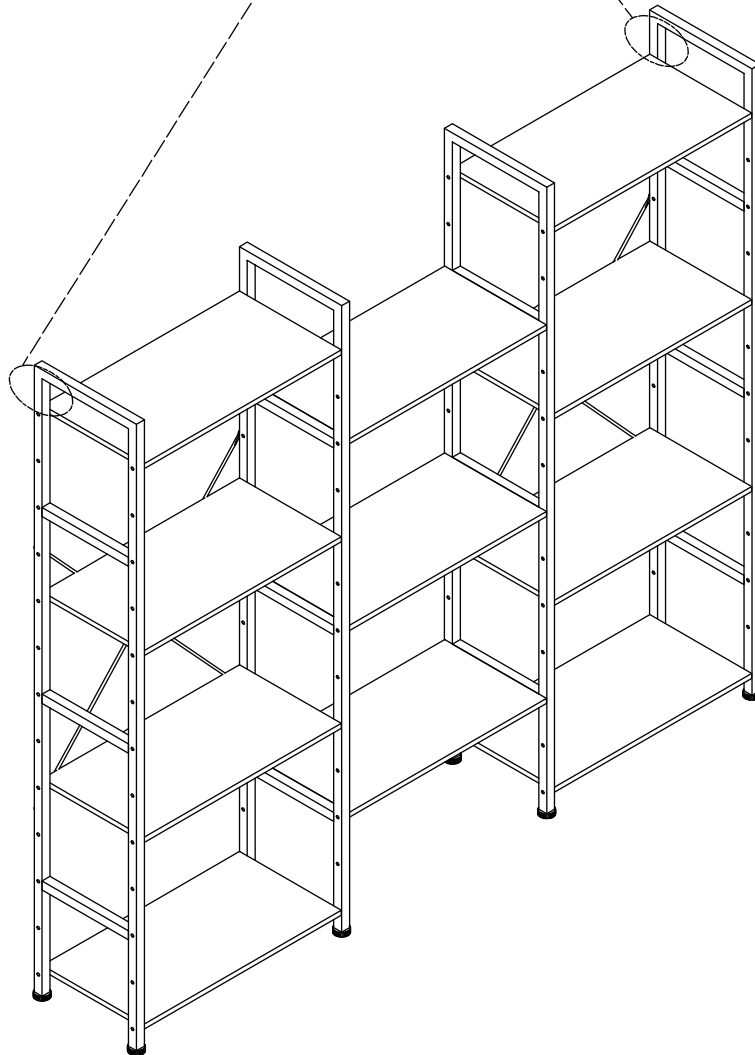

Step 6

EN: **Note:** Fully tighten all screws.

ES: **Nota:** Apriete completamente todos los tornillos.

FR: **Remarque :** Serrez toutes les vis complètement.

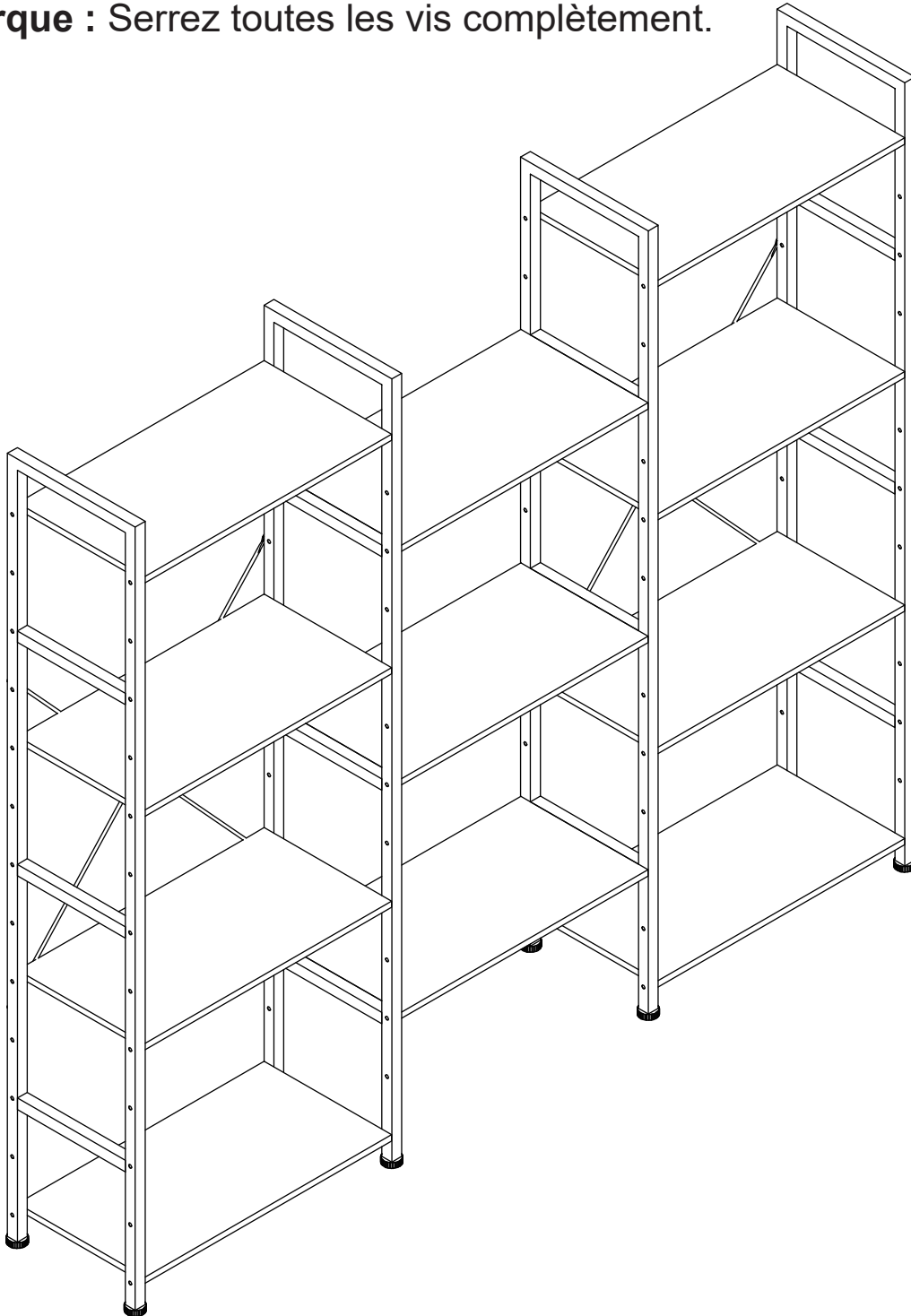

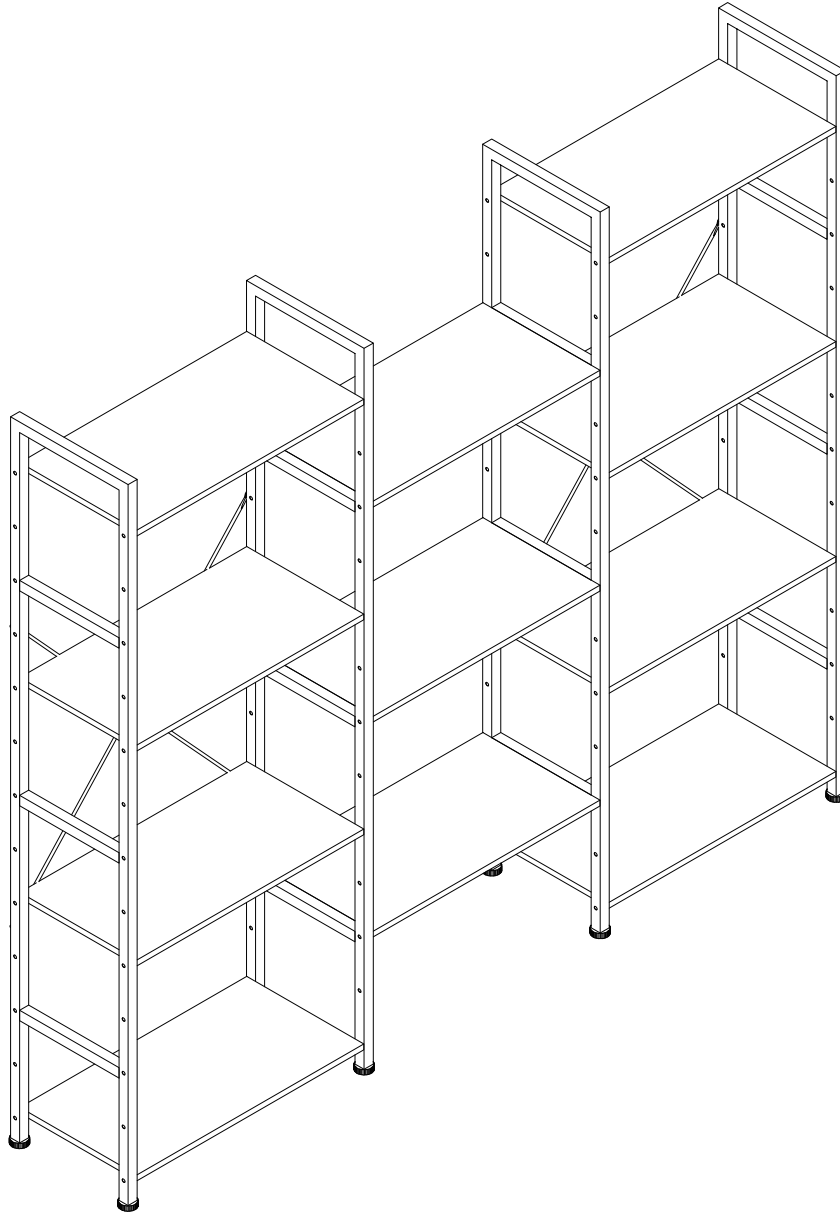

Thank you for choosing this product. We strive to provide you with the best quality products and service in the industry. Should you have any issues, please don't hesitate to contact us.