



84C-069



ASSEMBLY INSTRUCTIONS

Warning:











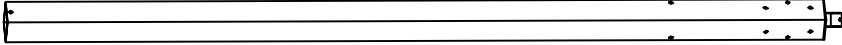

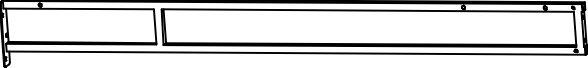





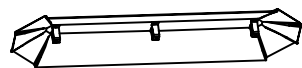
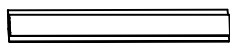

1. A 3 person assembly is required for this tent.
2. Please take appropriate actions as heavy rain, wind and snow can damage the tent. If necessary please dis-assemble and store for later use.
3. In snowy conditions please do not allow the thickness of the snow to be more than 5cm on the roof, this should be cleared as soon as possible for your safety.



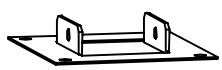
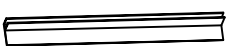

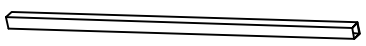

Warnhinweise:

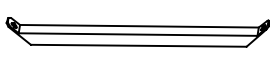
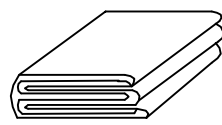
1. Bauen Sie das Zelt mit Hilfe von 3 Personen auf.
2. Stellen Sie das Zelt auf einen ebenen Untergrund auf und achten Sie darauf, dass sich keine offenen Feuerstellen in der Nähe befinden.
3. Um Beschädigungen des Zeltens zu vermeiden, benützen Sie es bitte nicht bei schlechten Wetterbedingungen wie starkem Regen, Wind oder Schneefällen. Für Schäden aufgrund schlechter Witterungsverhältnisse wird keine Haftung und Gewährleistung übernommen.
4. Bei Schneefall darf die Schneehöhe auf dem Dach 5 cm nicht überschreiten. Es obliegt Ihrer Verantwortung, das Zelt rechtzeitig und vorsichtig von der Schneelast zu befreien.
5. Sollten sich bei starkem Regen Wassertaschen auf dem Dach bilden, obliegt es Ihrer Verantwortung diese rechtzeitig und vorsichtig zu beseitigen.
6. Achten Sie beim Verstauen des Zeltens darauf alle Teile, insbesondere die Plane, vorher zu säubern und erst in trockenem Zustand einzupacken. Lagern Sie das Zelt an einem trockenen Ort.
7. Prüfen Sie vor Wiederaufbau des Zeltens die Vollständigkeit und Funktionalität aller für den Aufbau benötigten Teile.

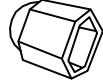
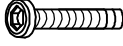
Attention:

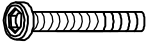
1. 3 personnes minimum requis pour le montage de la tente.
2. Ne pas utiliser la tente en période de pluie, de vent et de neige qui peuvent endommager la tente. Nous ne serons pas responsable de la mauvaise utilisation du produit.
3. Pour votre sécurité, en période de neige, il est recommandé de ne pas laisser de neige de plus de 5cm sur le toit.

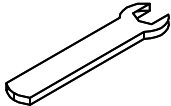
NO.	PARTS		QTY		
A			4pcs		
B			2pcs		
B1			2pcs		
C			2pcs		
C1			2pcs		
D			6pcs		
E			4pcs		
NO.	PARTS	QTY	NO.	PARTS	QTY
F		4pcs	O		1pc
G		4pcs	P		1pc
H		2pcs	Q		6pcs
I		4pcs	R		4pcs
J		4pcs	S		4pcs
K		2pcs	T		8pcs
L		4pcs	U1		8pcs
M		4pcs	U2		8pcs
N		8pcs	W		4pcs

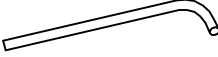
NO.	PARTS	QTY	NO.	PARTS	QTY
X1	 M6*15	97pcs	Z		8pcs
X2	 M6*40	16pcs			1pc
X3	  M6*55	8pcs			1pc
Y		105pcs			16pcs

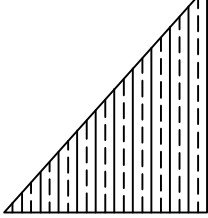
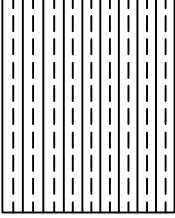
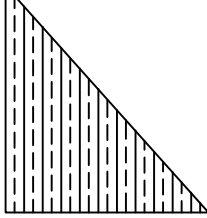
NO.	1	3	4
PARTS			
QTY	4pcs	2pcs	4pcs

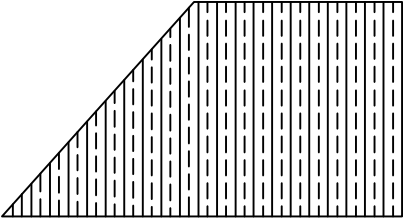
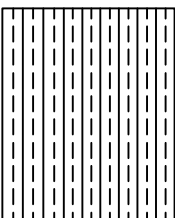
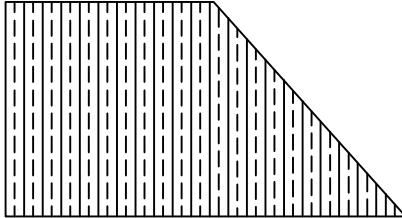
NO.	2	3	5
PARTS			
QTY	4pcs	2pcs	4pcs

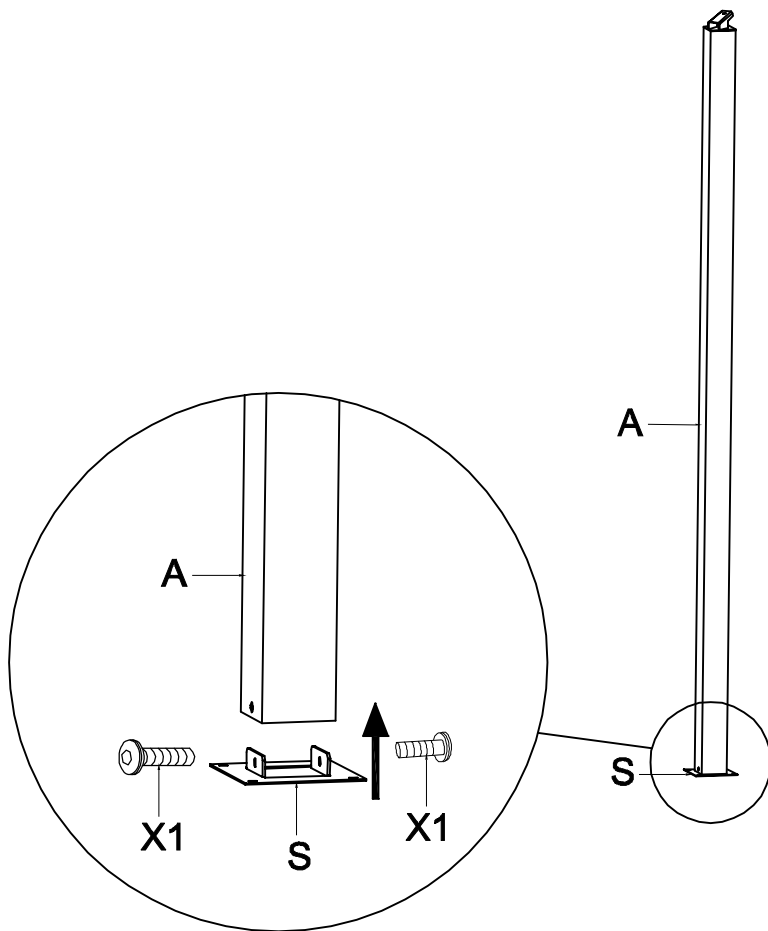
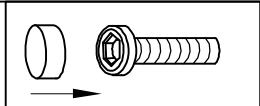

1.

2.

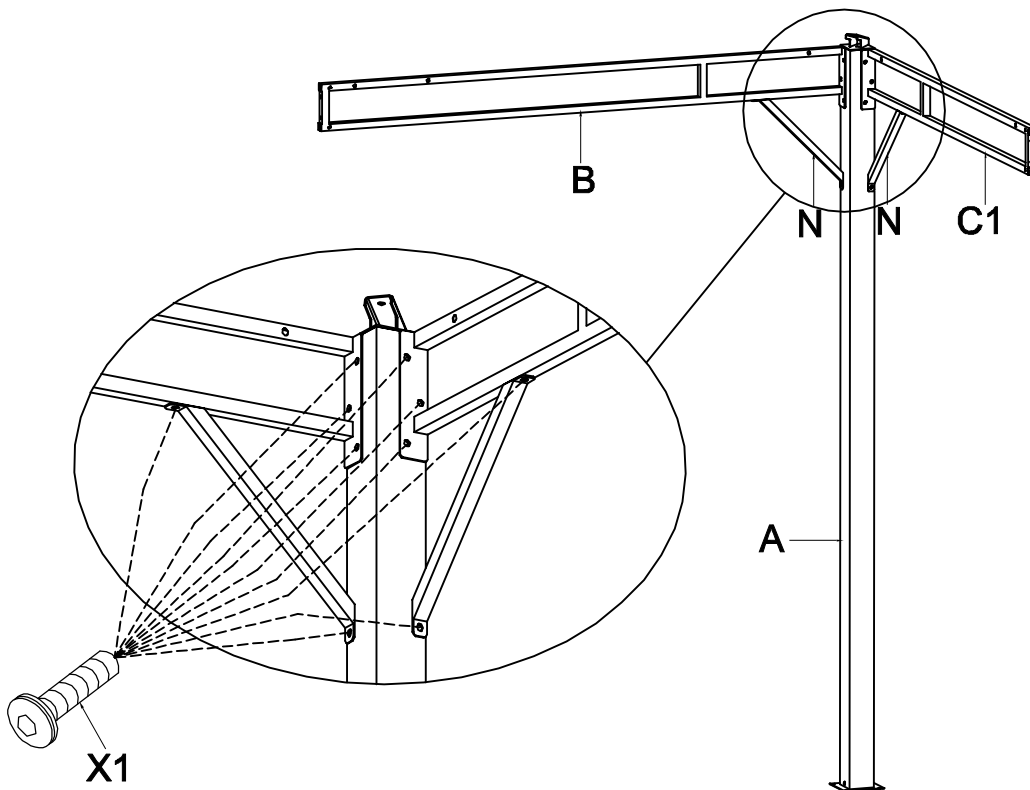
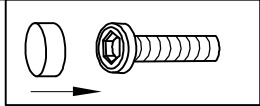

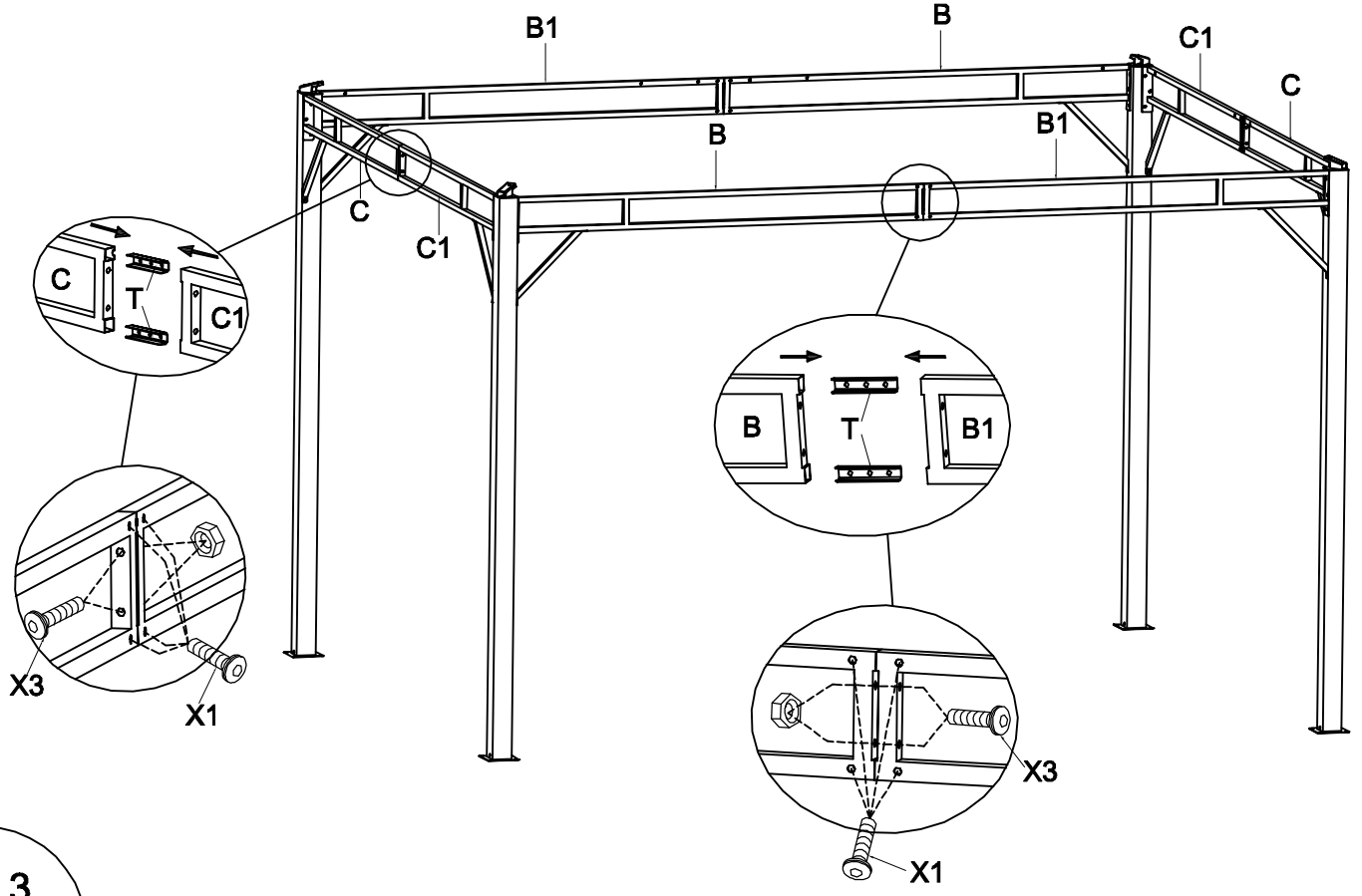
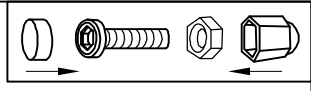

4.

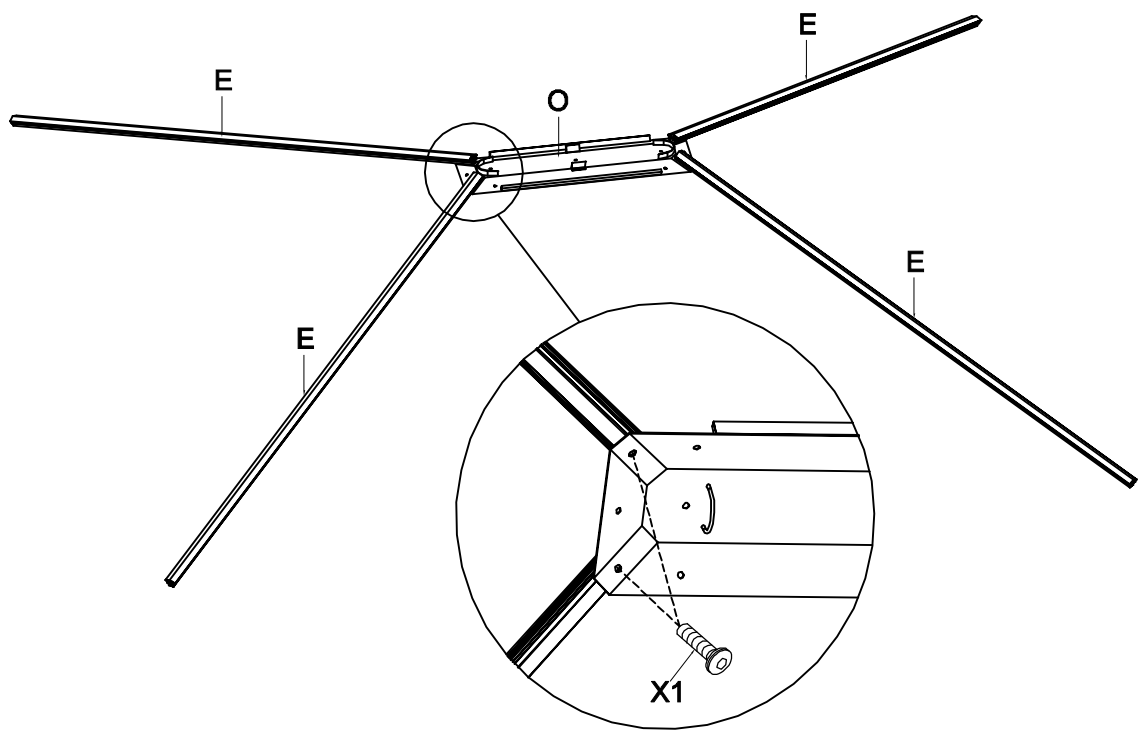
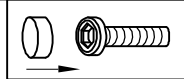

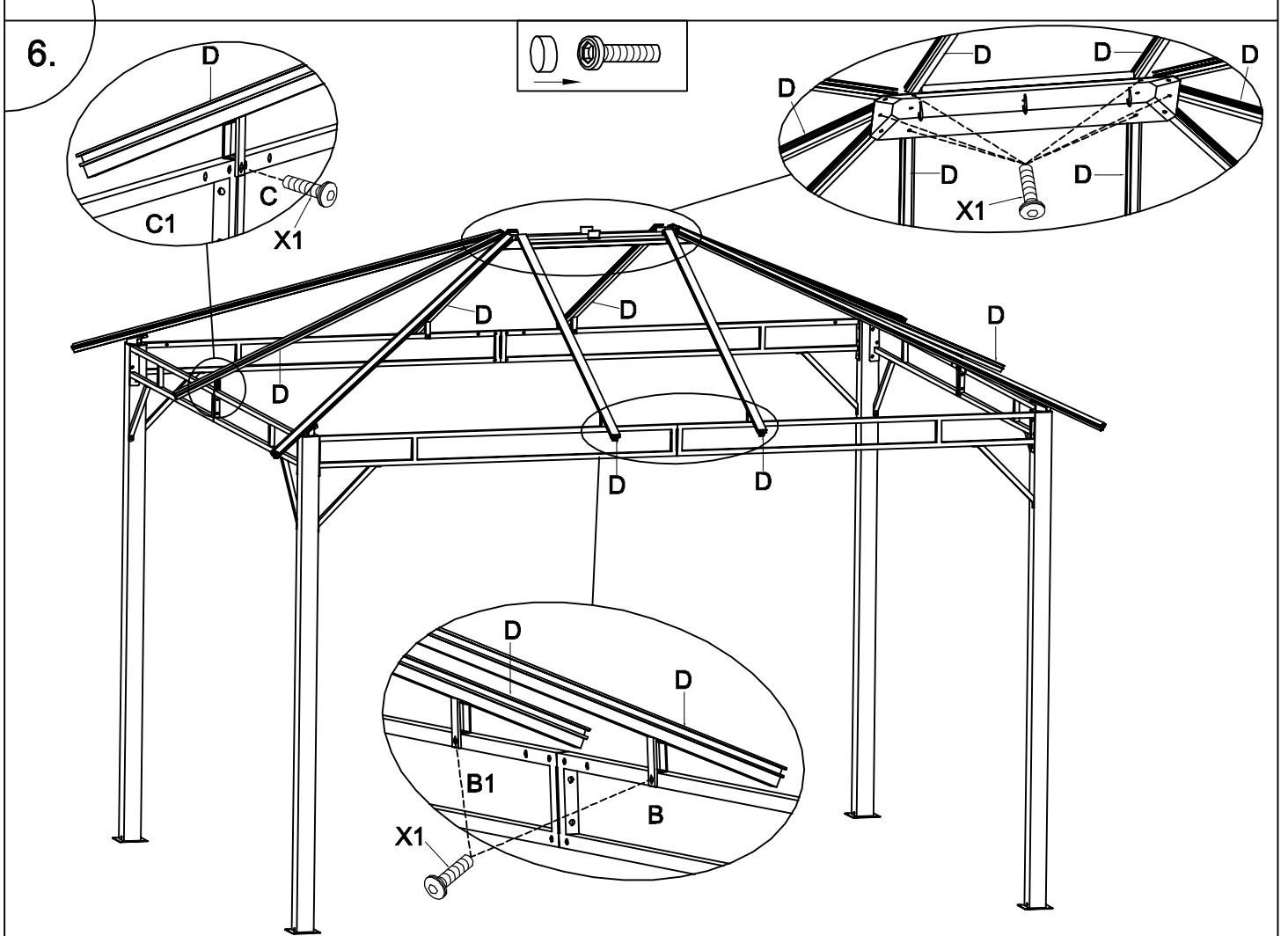
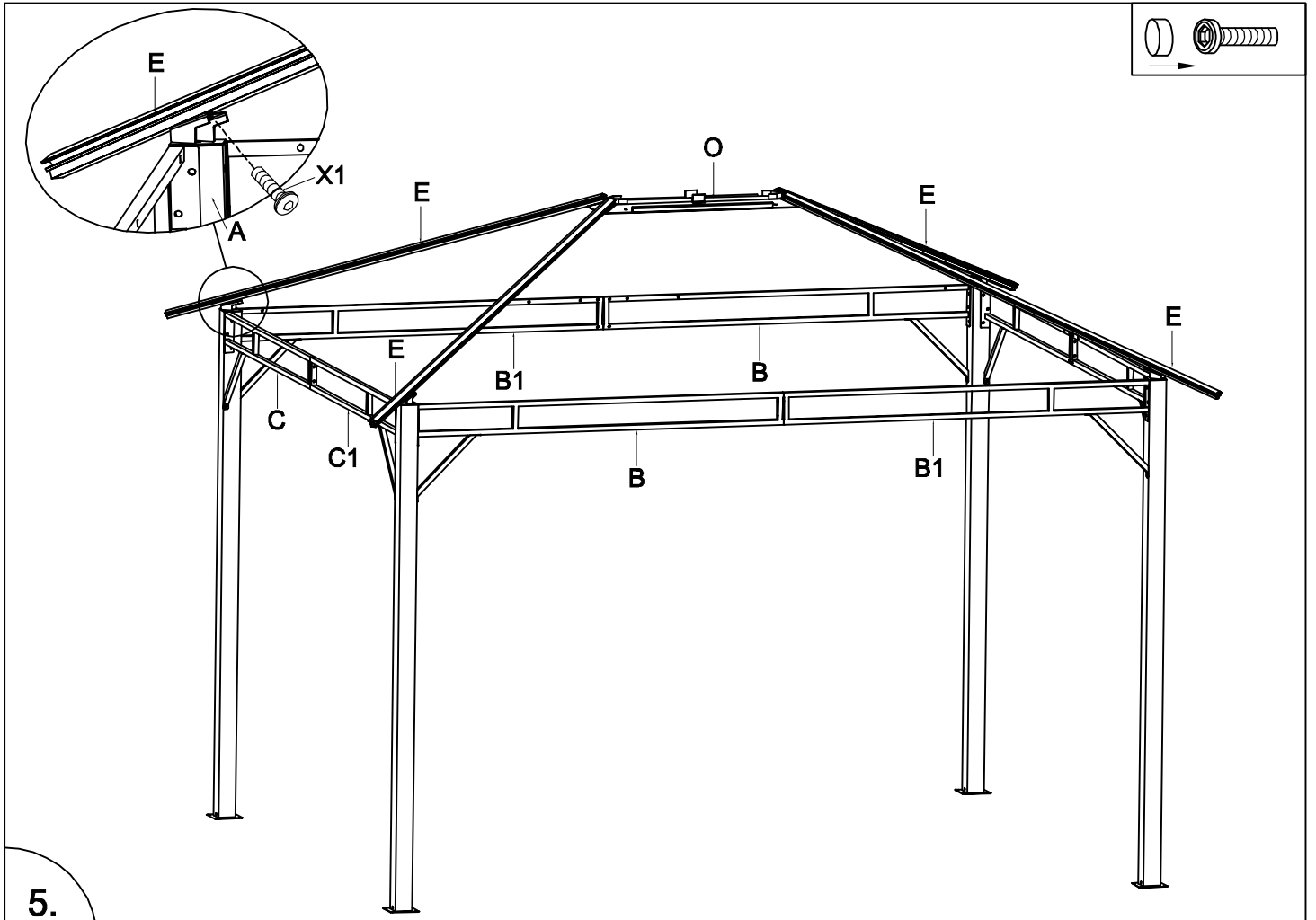

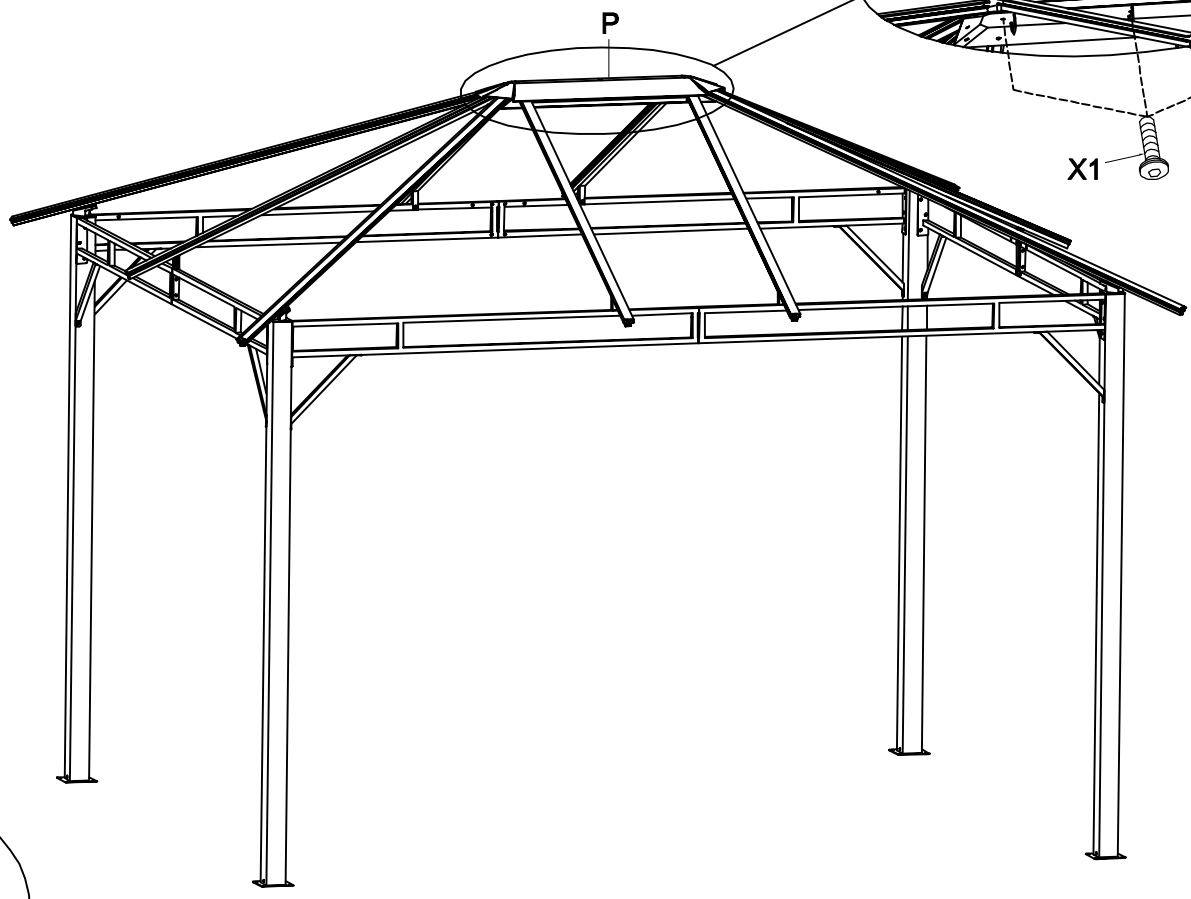
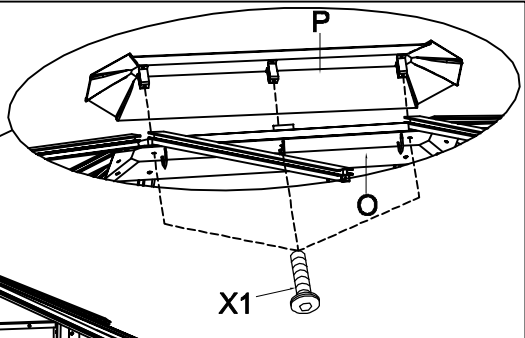
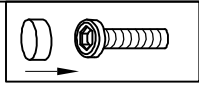

7.

8.

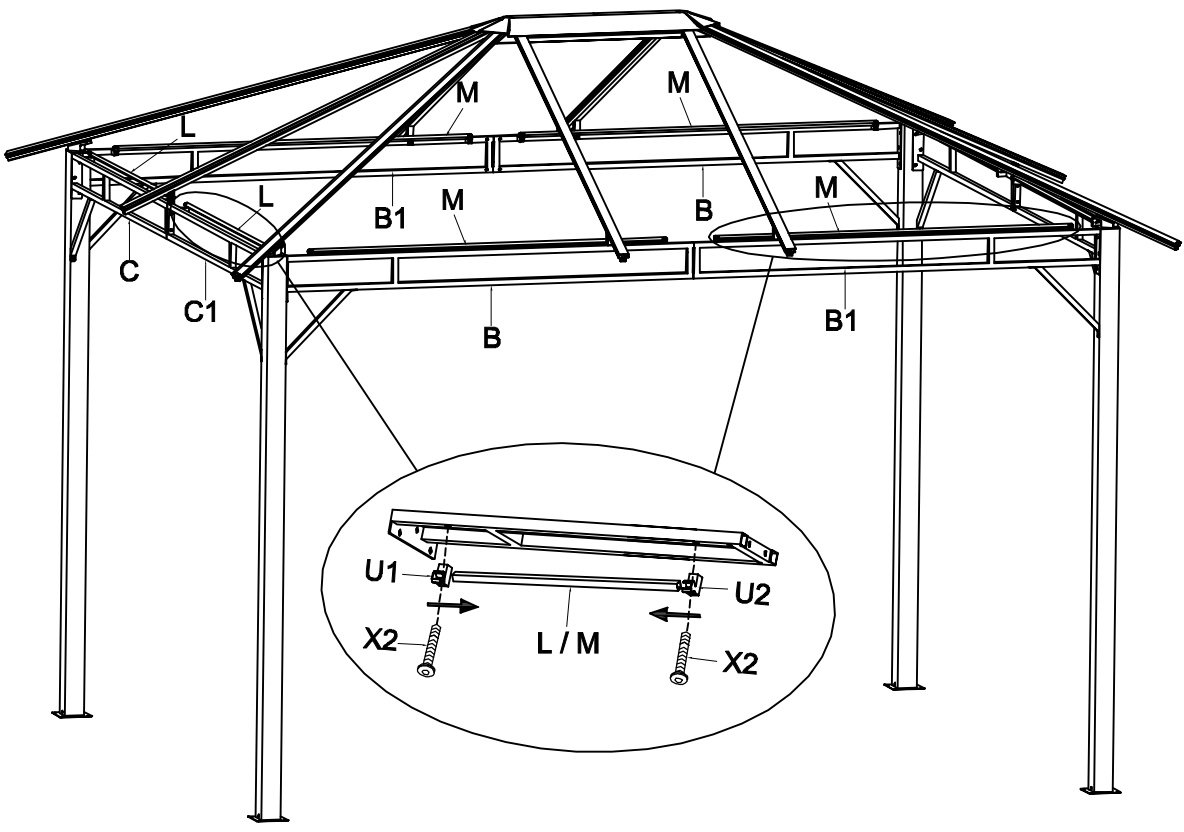

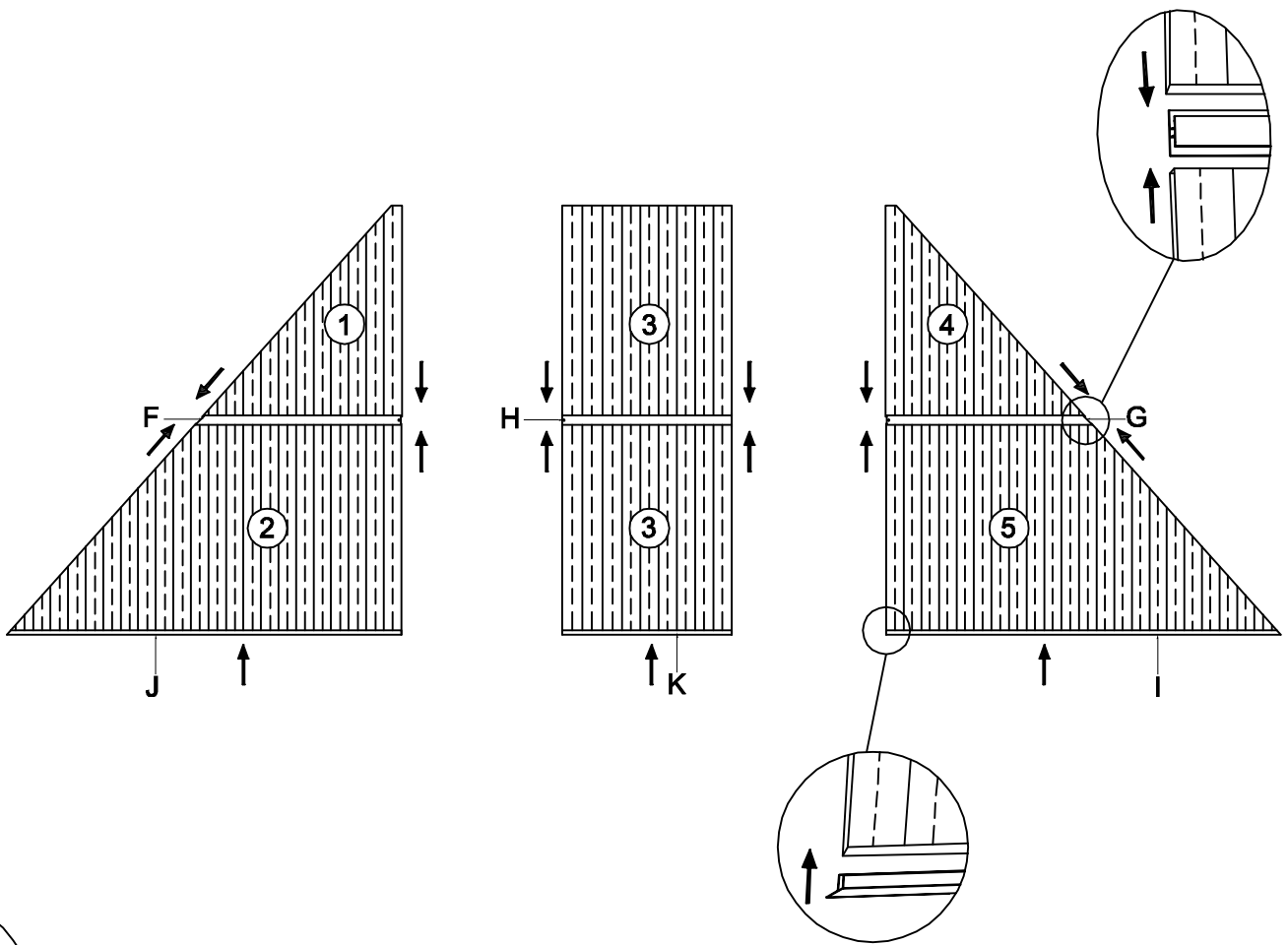

9.

10.

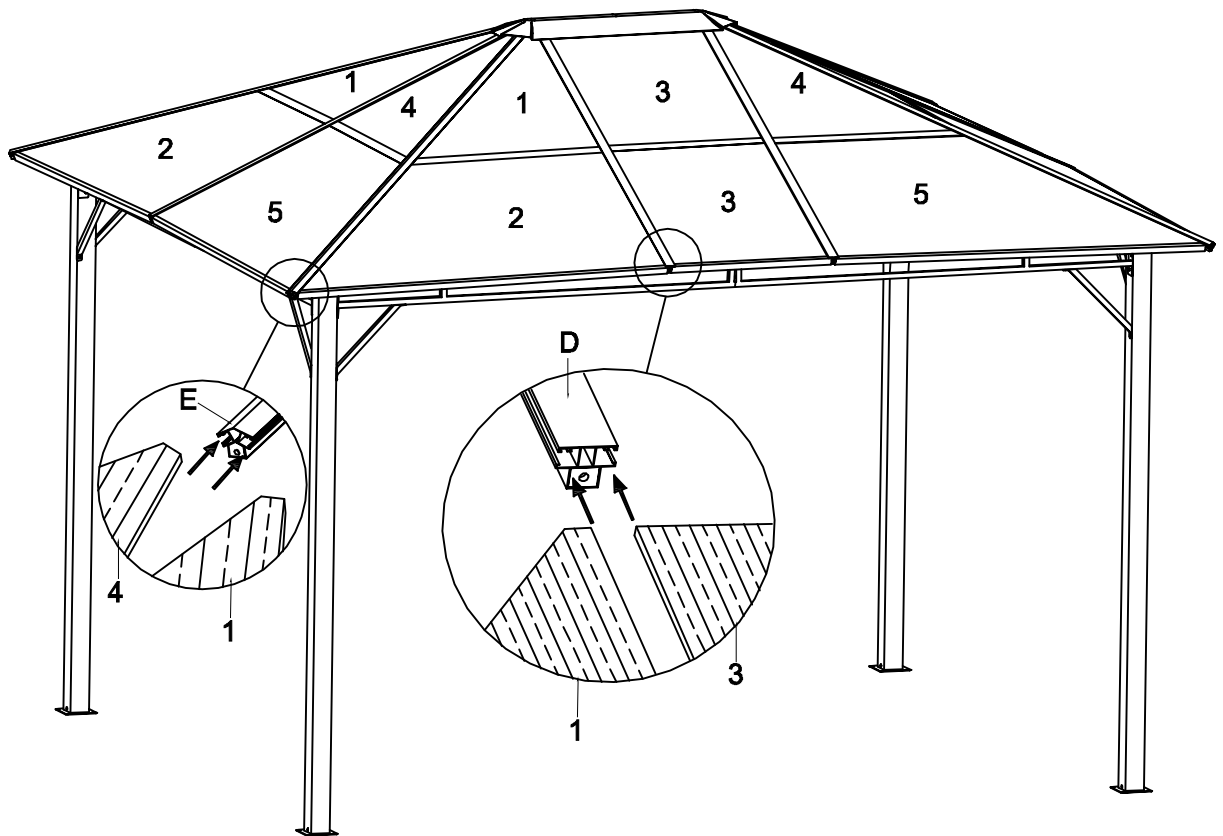

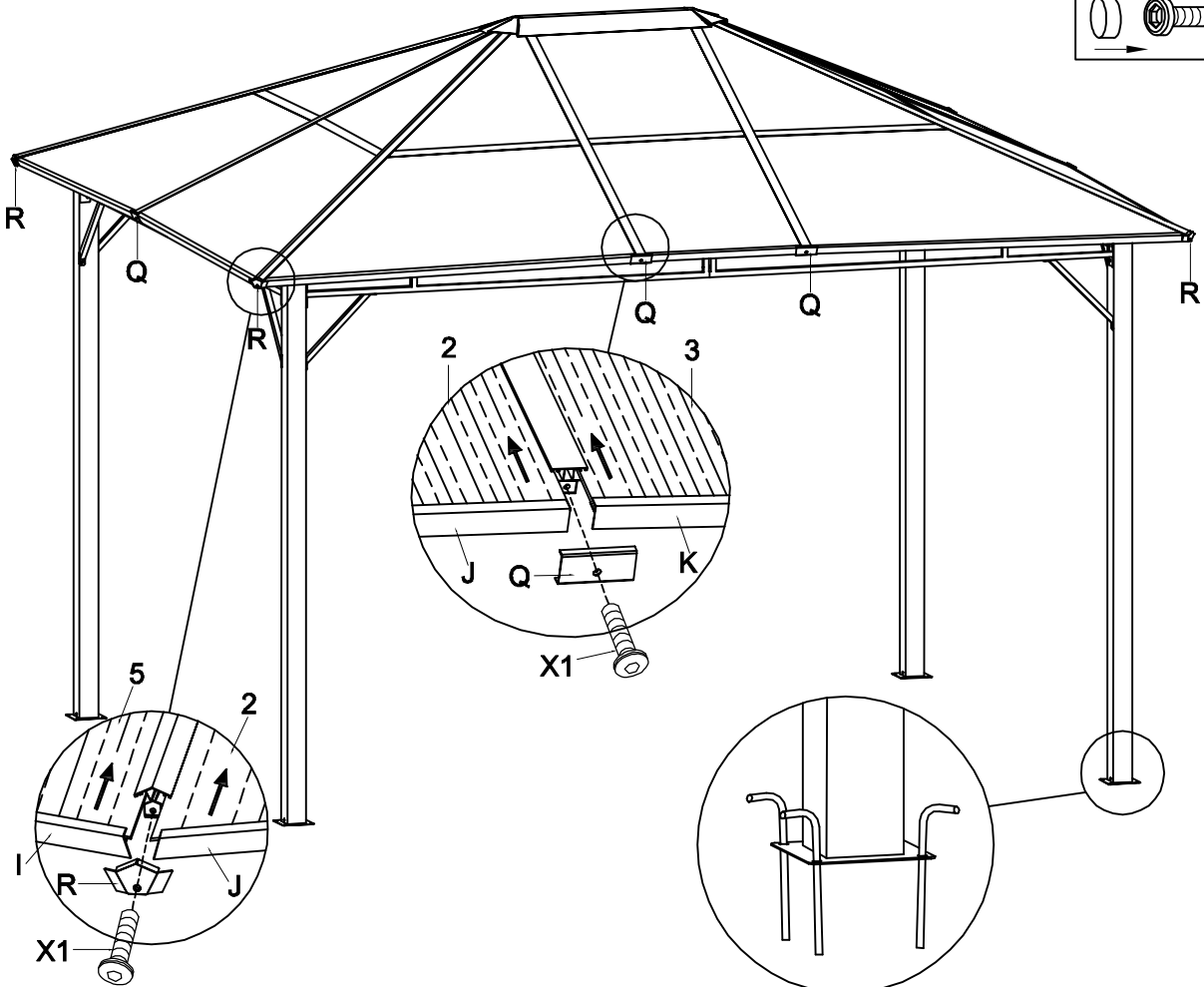
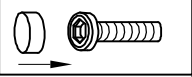

11.

12.

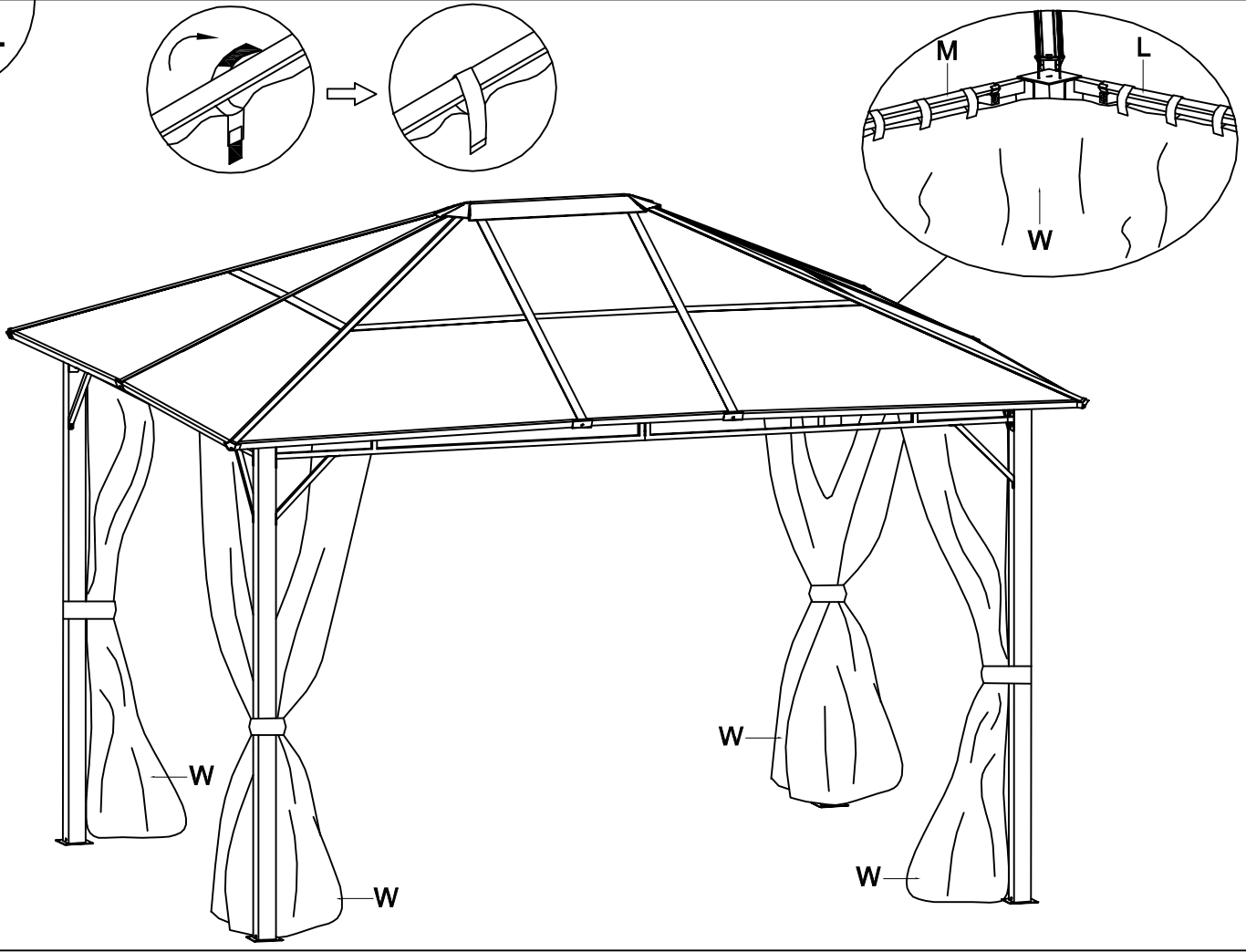

W

W

W