

ASSEMBLY INSTRUCTIONS

GENERAL BEST PRACTICES FOR ASSEMBLY:

Read all instructions before starting

Clear a large area for assembly and assemble on cardboard, carpet or a blanket to protect the finish

Note that hardware required is provided for every step

Pay attention to orientation

Number of the part corresponds to a sticker on the part

Letter of the hardware corresponds to its letter in the package

Helpful hints provided along the way

WARNINGS:

CAUTION: Adult assembly required.

Assemble on soft surfaces to prevent damage to the product finish.

Do not use power tools.

MAINTENANCE

Use a soft, clean cloth that will not scratch the surface when dusting, use of furniture polishes is not necessary.

Never use water to clean your furniture as it may cause damages to the finish.

Do not scratch or chip the finish.

Do not place objects which are more than 80 degrees fahrenheit directly on the surface.

Check bolts/screws periodically and tighten if necessary.

It is advised to keep furniture away from direct sunlight as it may damage the finish.

To prolong the life of product we recommend storage in a dry area when not in use or during austere weather conditions.

PARTS LIST

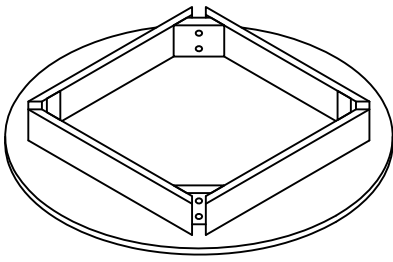

A

X1
Table top

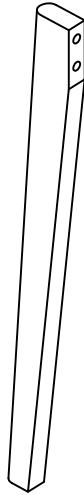

B

X4
Table leg

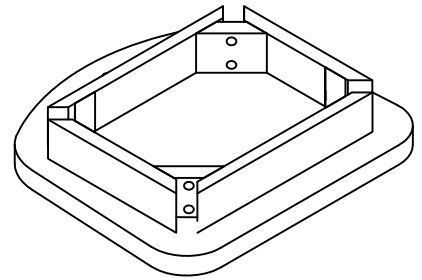

C

X2
Seat frame

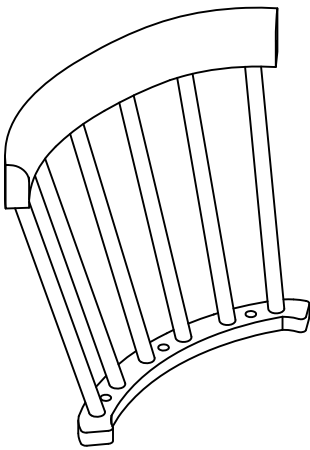

D

X2
Back rest

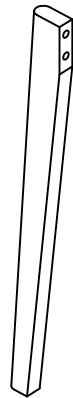

E

X8
Chair leg

HARDWARE LIST

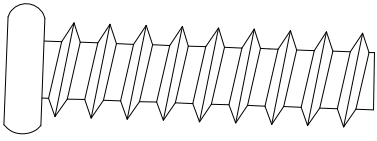

1

X24
Bolt
Ø1/4"*2"

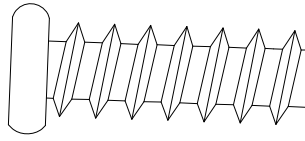

2

X6
Bolt
Ø1/4"*1-1/4"

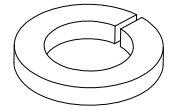

3

X24
Spring washer
Ø1/4"*1.2MM

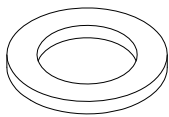

4

X24
Flat washer
Ø1/4"*1.5MM

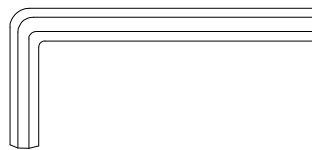

5

X1
Allen wrench
4MM

STEP1

Place Table Top (A) upside down on a non-abrasive surface such as carpet (underside of Table Top should be facing up).

Attach Table Legs (B) to the apron of Table top (A) using 8 Bolts (1), 8 Spring washer (3) and 8 Flat washer (4).

Tighten using Allen Wrench (5) as shown below.

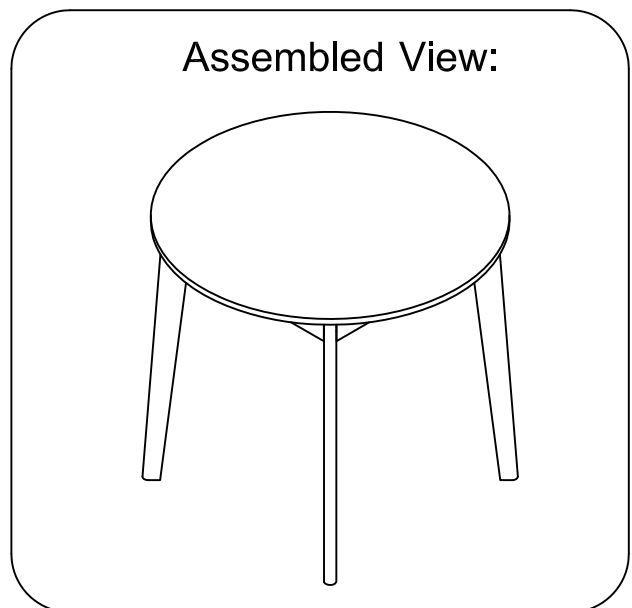
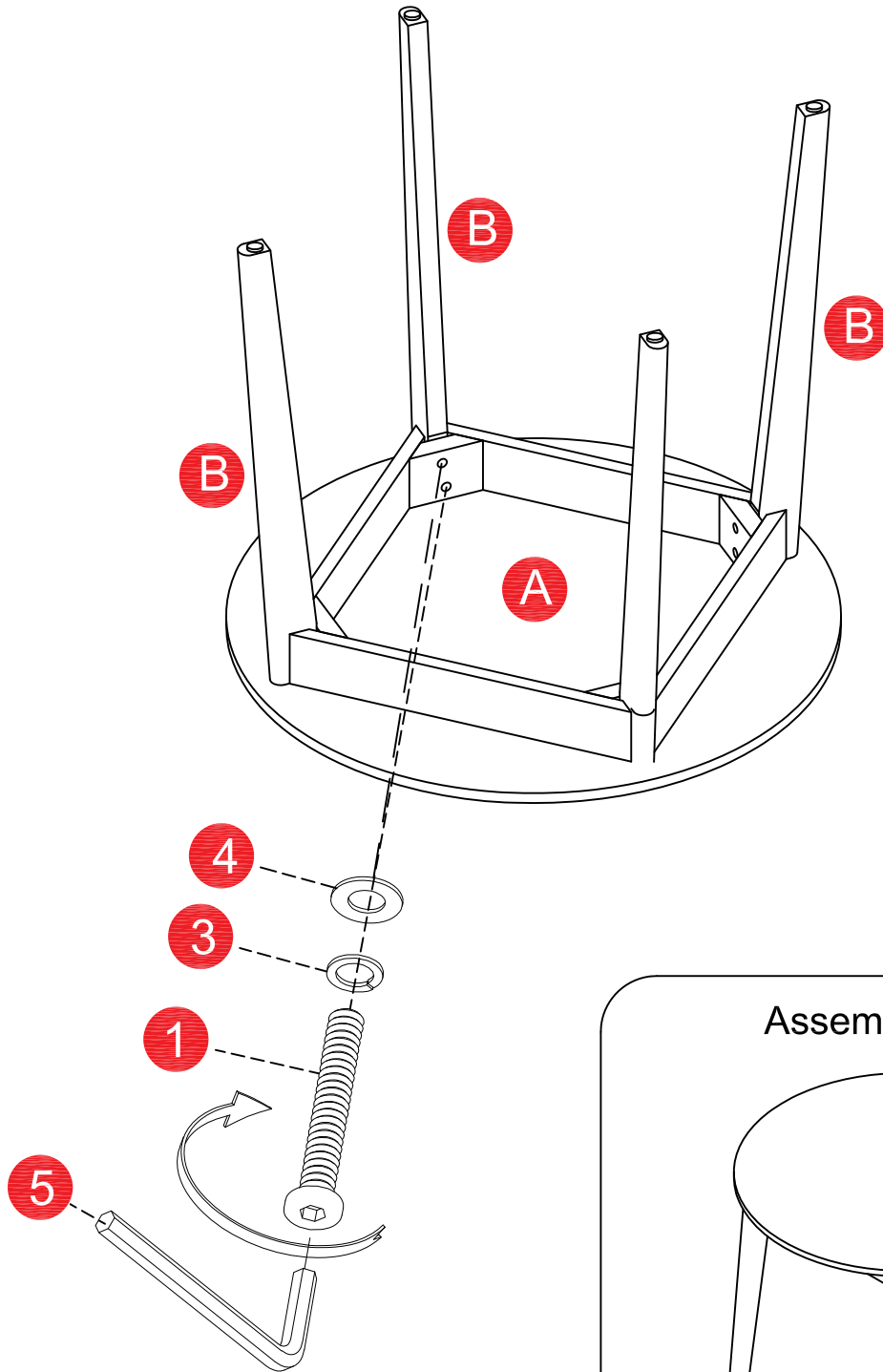
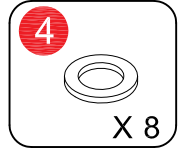
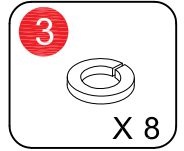
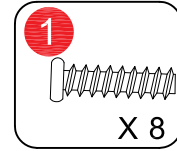

STEP2

Place Seat frame (C) upside down on a non-abrasive surface such as carpet (underside of Table Top should be facing up).

Attach Chair leg (E) to the apron of Seat frame (C), using 16 Bolts (1)
16 Spring washer (3) and 16 Flat washer (4).

Tighten using Allen Wrench (5) as shown below.

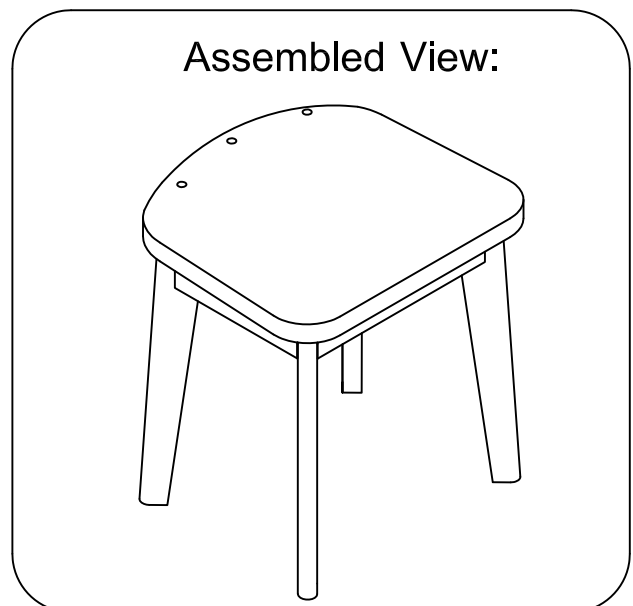
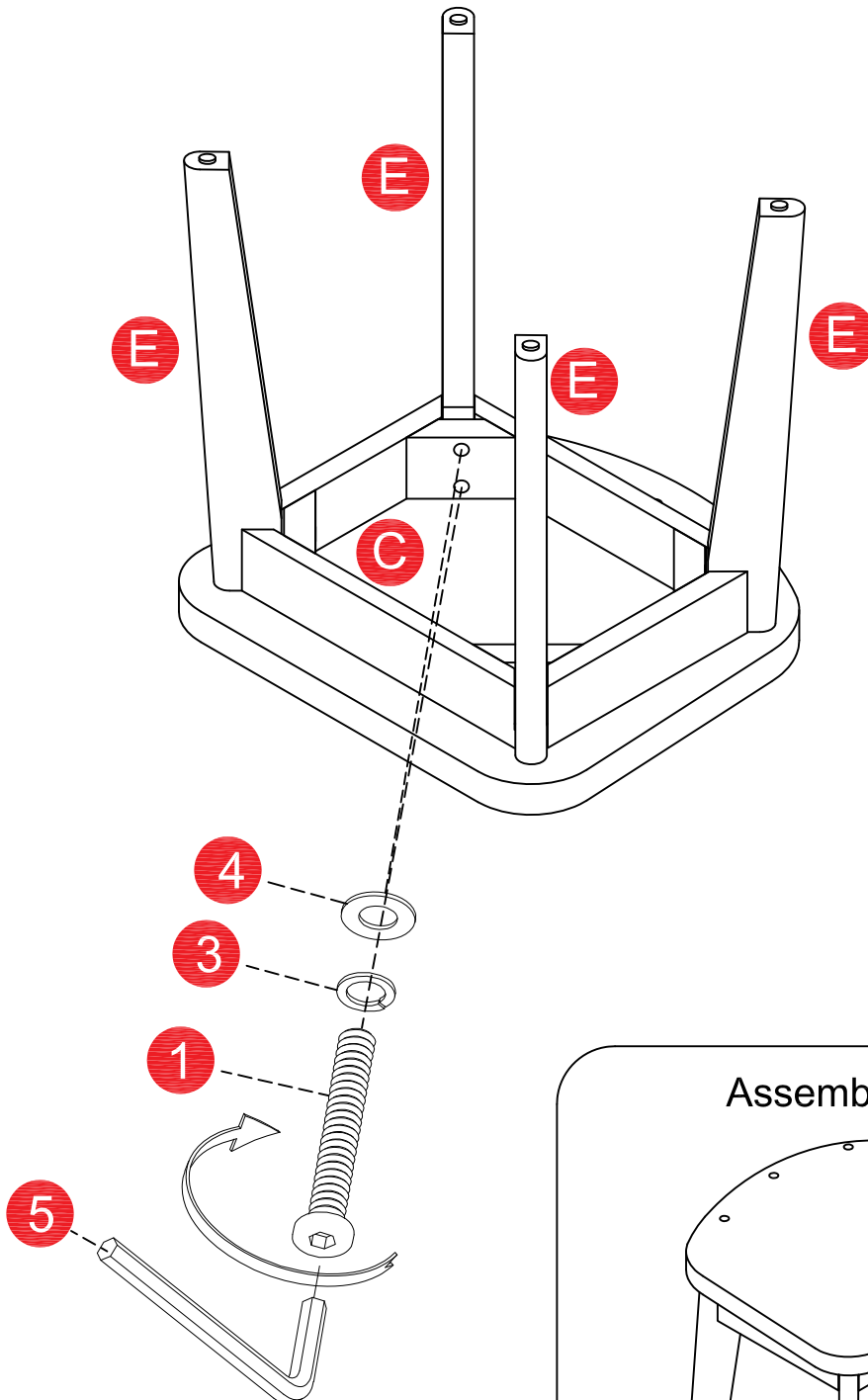
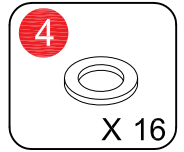
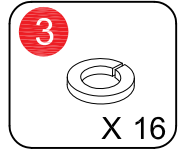
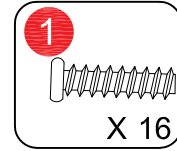

STEP 3

Attach Back rest (D) to Seat frame (C) using 6 Bolts (2) ,Tighten using Allen Wrench (5) as shown below.
Repeat this step for the remaining chair

