

WP FURNITURE / INSTRUCTIONS

Model# 1435 (DD)

Need Assistance? - 315-7580-751 - Text

email: lori@shopwp.com



Hardware List			
A2		Screw m3.5 x 14mm	102 pcs
A7		Screw m4 x 30mm	12 pcs
A10		Screw m4 x 38mm	24 pcs
A17		Screw m6.3 x 40mm	12 pcs
A34		Euro Screw m5 x 8mm	24 pcs
D4		Wood Dowel 6 x 25mm	32 pcs
E21		Anti-Tipping Pack	1 set
F2		Mini Fix 15mm	30 sets
F3		Mini Fix 64mm (Double End Bolt)	2 sets
H21		Black Handle 128mm	6 pcs
L2		Plastic Leg L Shape	6 pcs
M6		Drawer Metal Slide 350mm	6 sets
N1		Allen Key	1 pc
N3		Nail	40 (+-3) pcs
R2		Single Plastic Cap	36 pcs
Y		Crosshead Cover	8 pcs

WP FURNITURE / INSTRUCTIONS

Model# 1435 (DD)

Need Assistance? - 315-7580-751 - Text

email: lori@shopwp.com

Place your screw on top of the scale to identify their size.

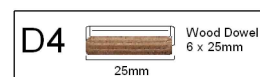
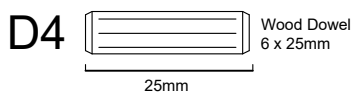
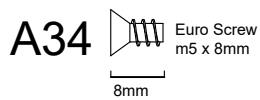
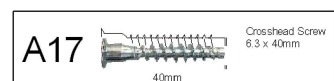
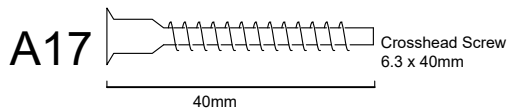
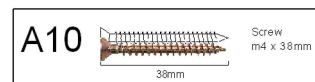
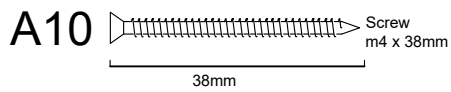
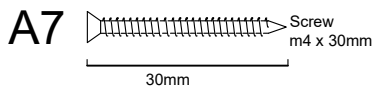
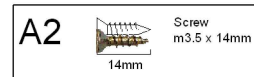
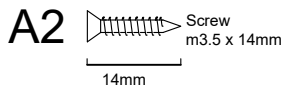

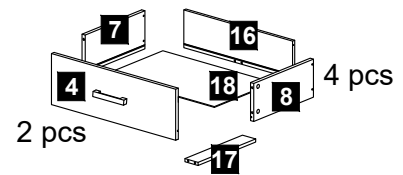
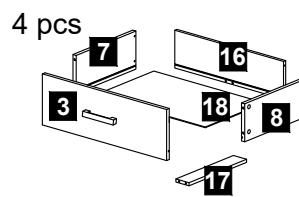
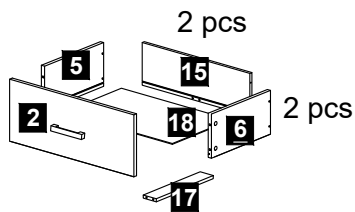
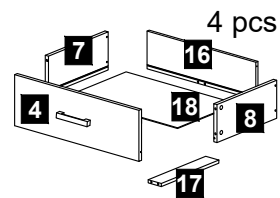
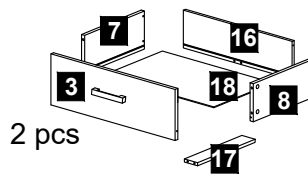
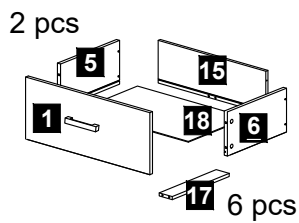
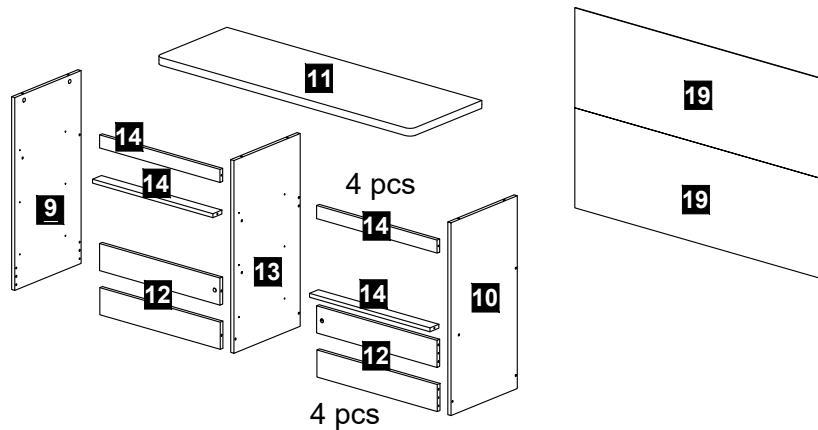

Parts List		
1	Big Drawer Front Panel (L)	1 pc
2	Big Drawer Front Panel (R)	1 pc
3	Drawer Front Panel (L)	2 pcs
4	Drawer Front Panel (R)	2 pcs
5	Big Drawer Side Panel (L)	2 pcs
6	Big Drawer Side Panel (R)	2 pcs
7	Drawer Side Panel (L)	4 pcs
8	Drawer Side Panel (R)	4 pcs
9	Side Panel (L)	1 pc

10	Side Panel (R)	1 pc
11	Top Panel	1 pc
12	Crossbar Panel	4 pcs
13	Center Panel	1 pc
14	Small Crossbar	4 pcs
15	Drawer Big Back Board	2 pcs
16	Drawer Back Board	4 pcs
17	Drawer Crossbar	6 pcs
18	Drawer Bottom Panel	6 pcs
19	Backboard	2 pcs





EACH PART IS LABELLED ACCORDING TO THE PARTS LIST

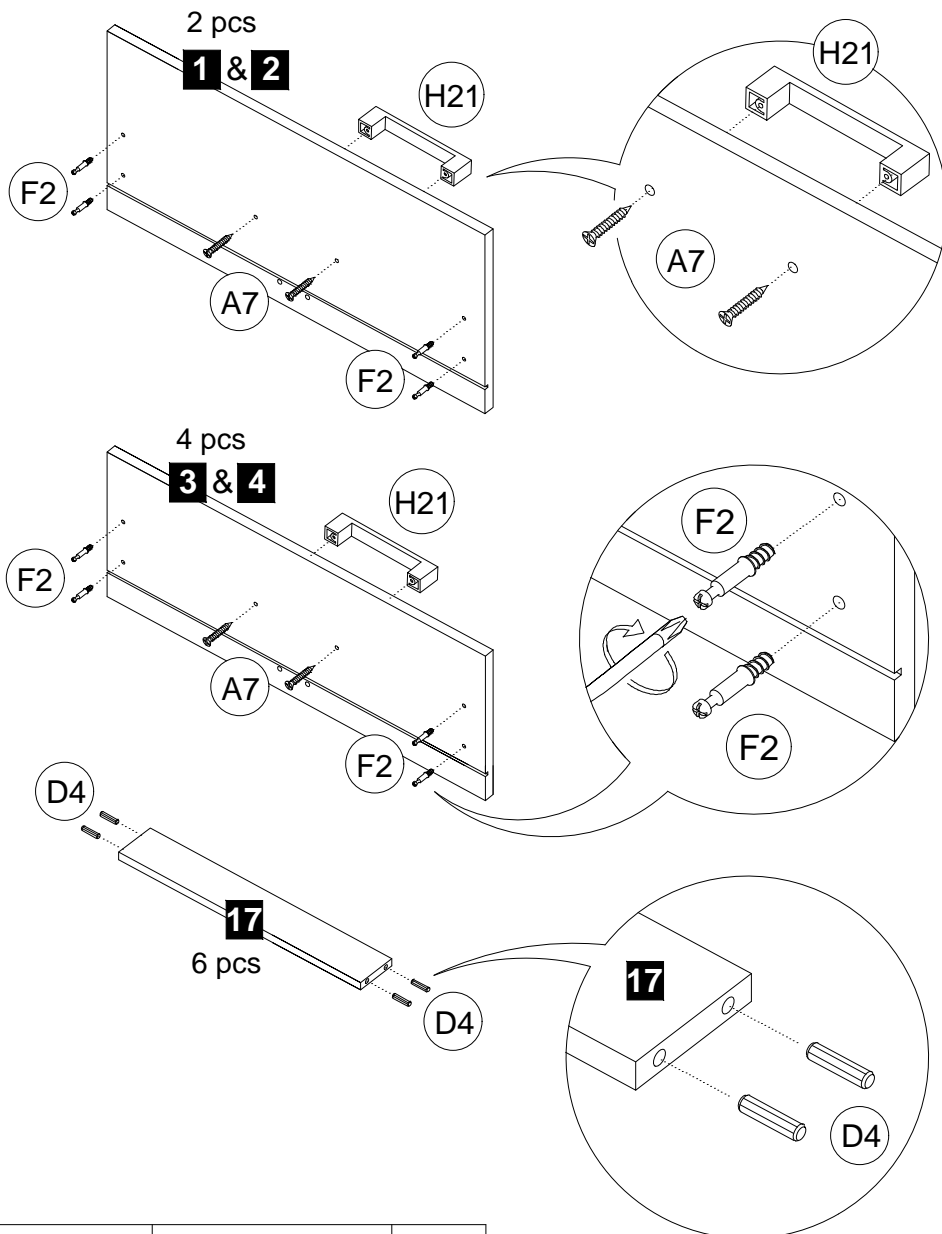

Before starting assembly
please verify if all parts and
hardware are included

STEP 1



A7		Screw m4 x 30mm	12 pcs
F2		Mini Fix Bolt	24 pcs
D4		Wood Dowel 6 x 25mm	24 pcs
H21		Black Handle 128mm	6 pcs

STEP 2

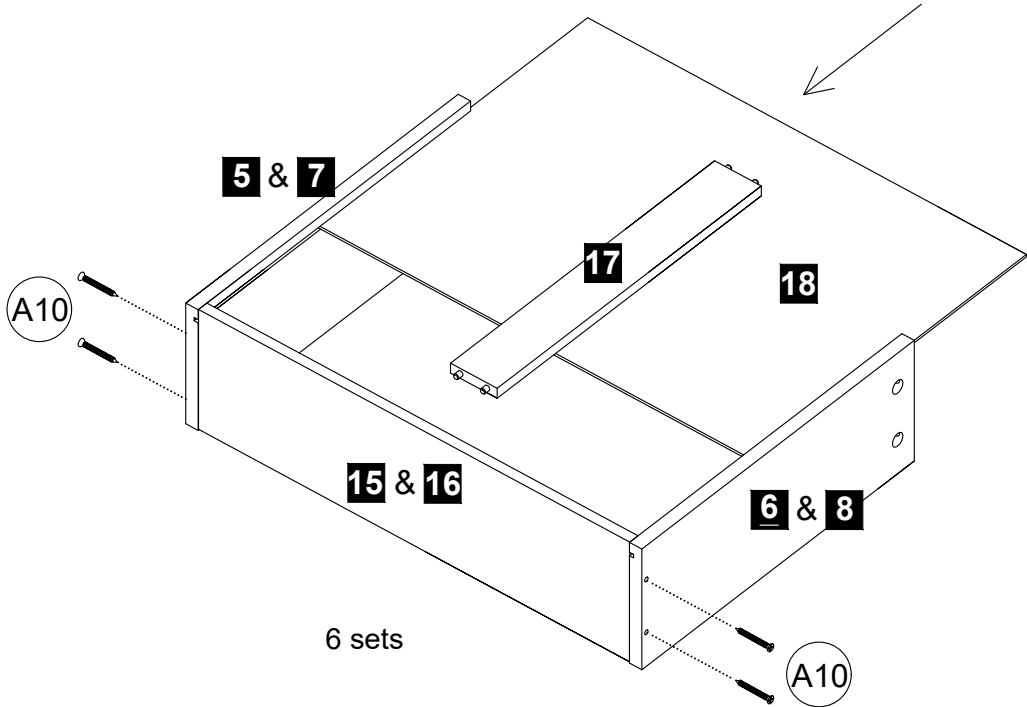

A10		Screw m4 x 38mm	24 pcs
-----	---	-----------------	--------

STEP 3

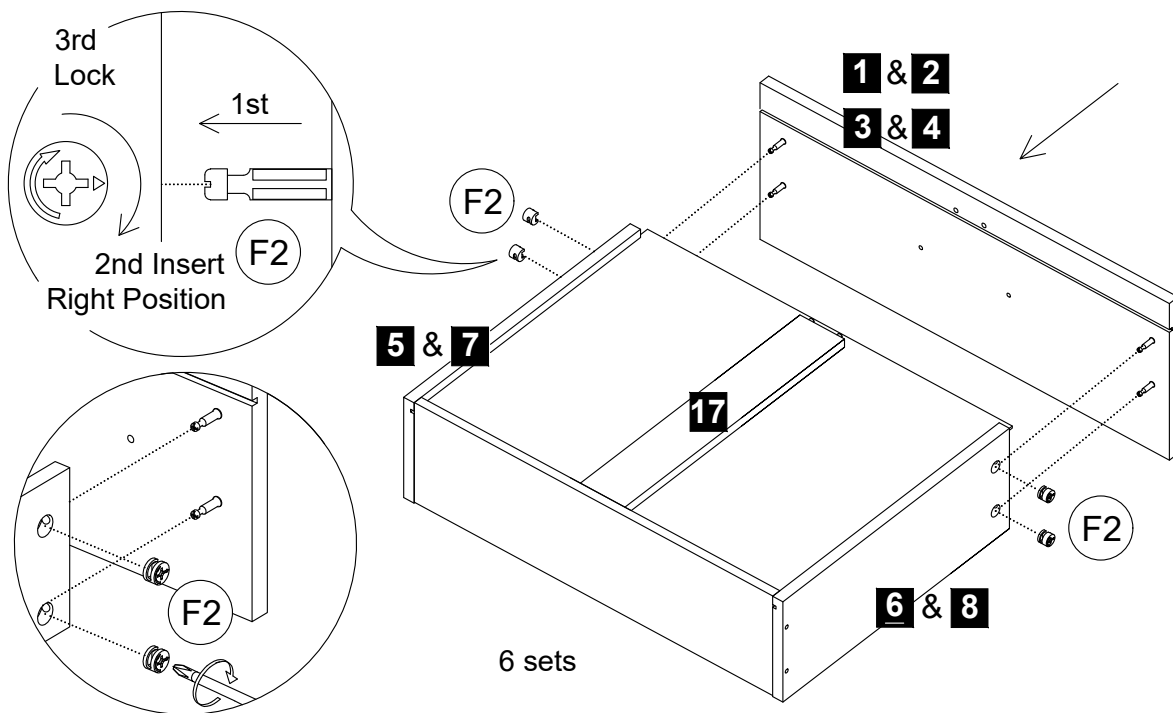



F2		Mini Fix 15mm	24 sets
----	---	---------------	---------

STEP 4

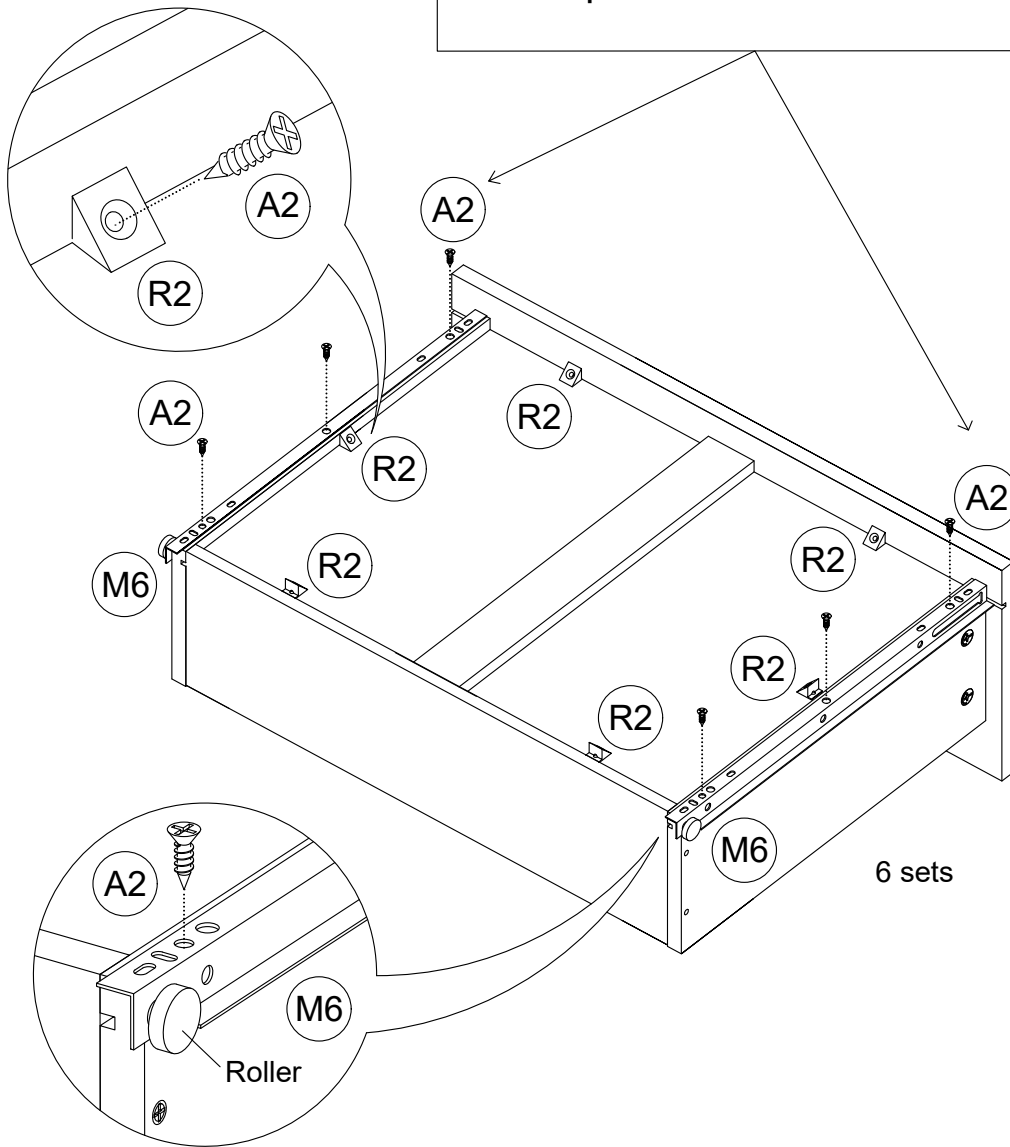
IMPORTANT!
Please put the screws in this way.

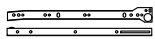

A2		Screw m3.5 x 14mm	72 pcs
R2		Single Plastic Cap	36 pcs
M6		Drawer Metal Slide 350mm	6 sets

STEP 5

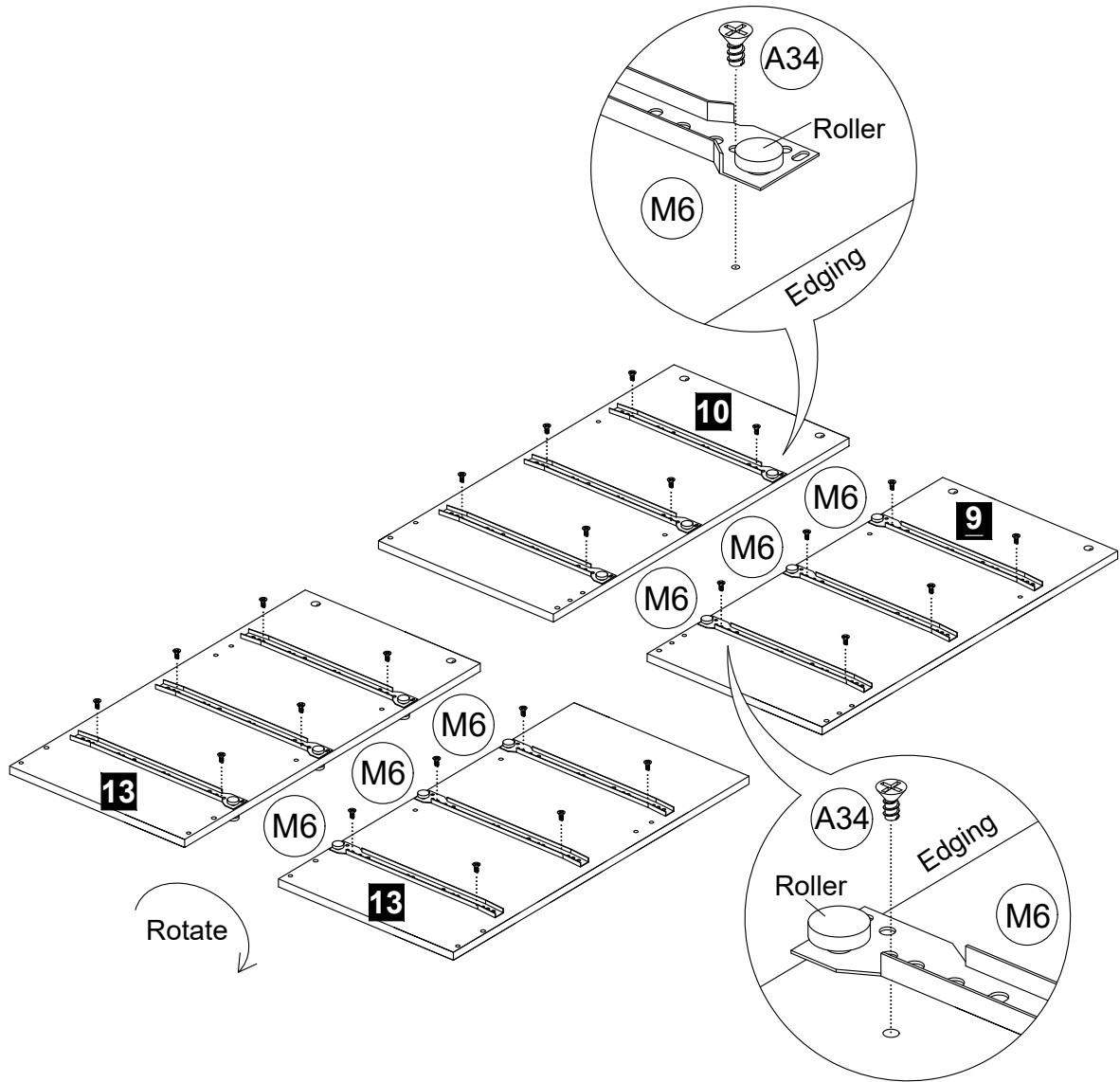

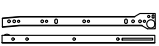
A34		Euro Screw m5 x 8mm	24 pcs
M6		Drawer Metal Slide 350mm	6 sets

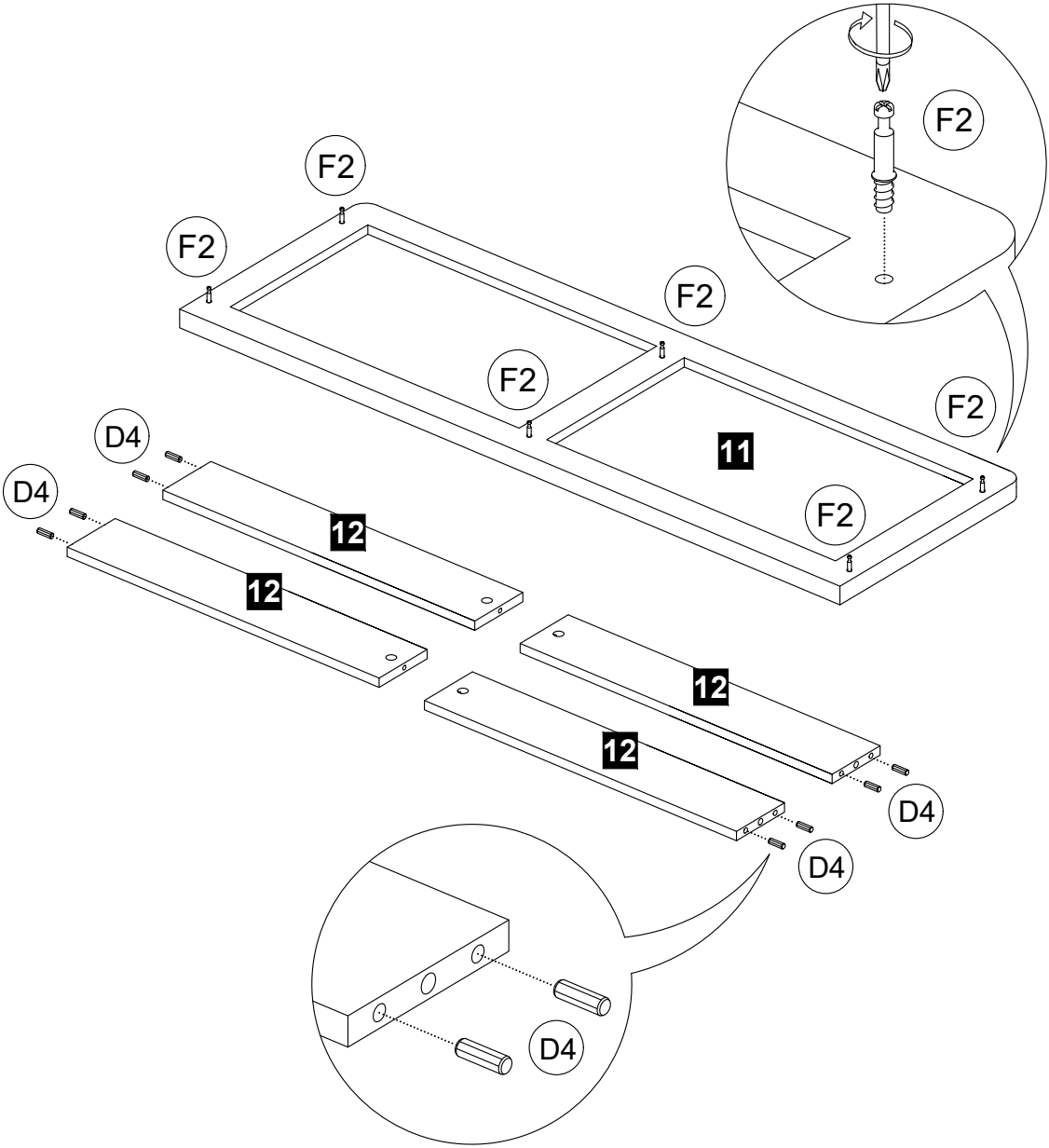

STEP 6



D4		Wood Dowel 6 x 25mm	8 pcs
F2		Mini Fix Bolt	6 pcs

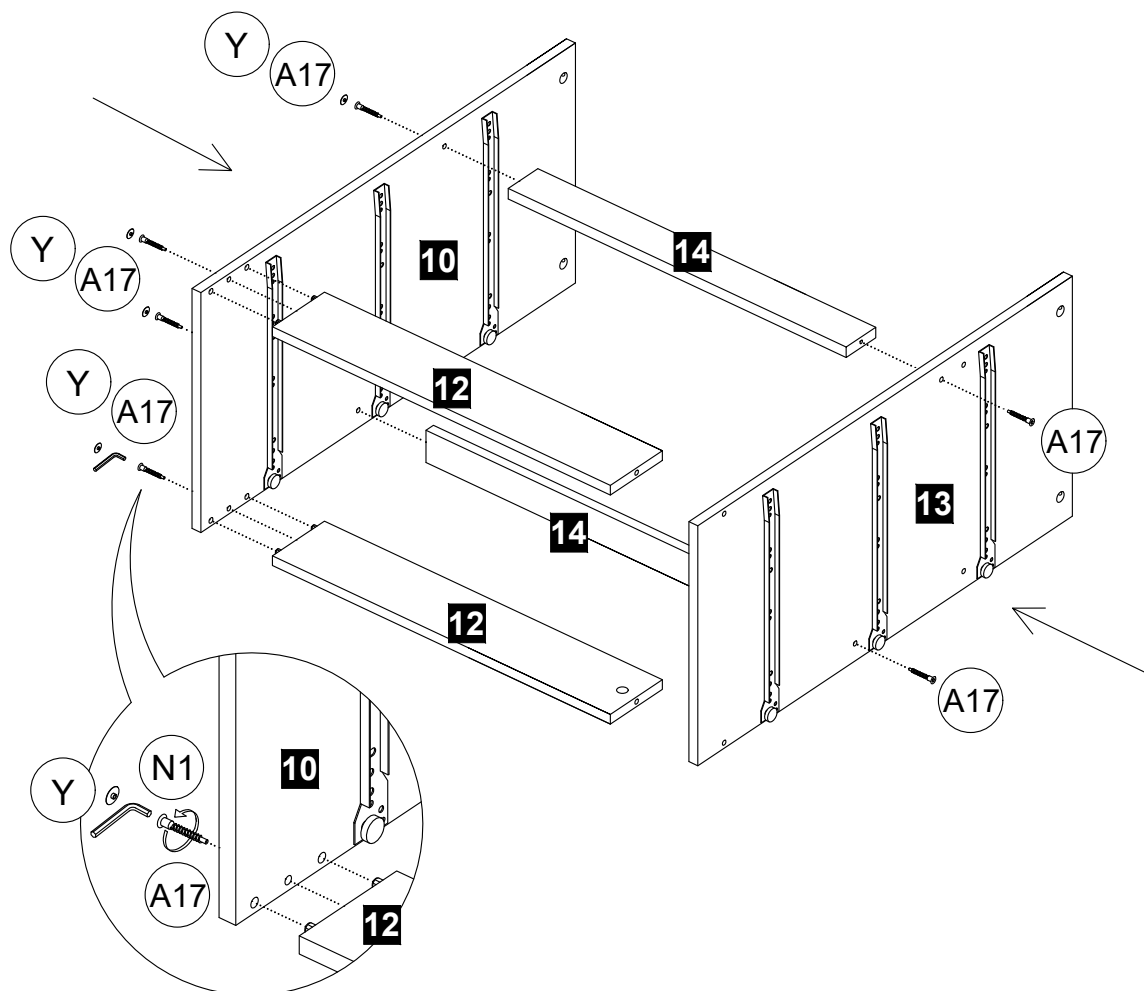

STEP 7

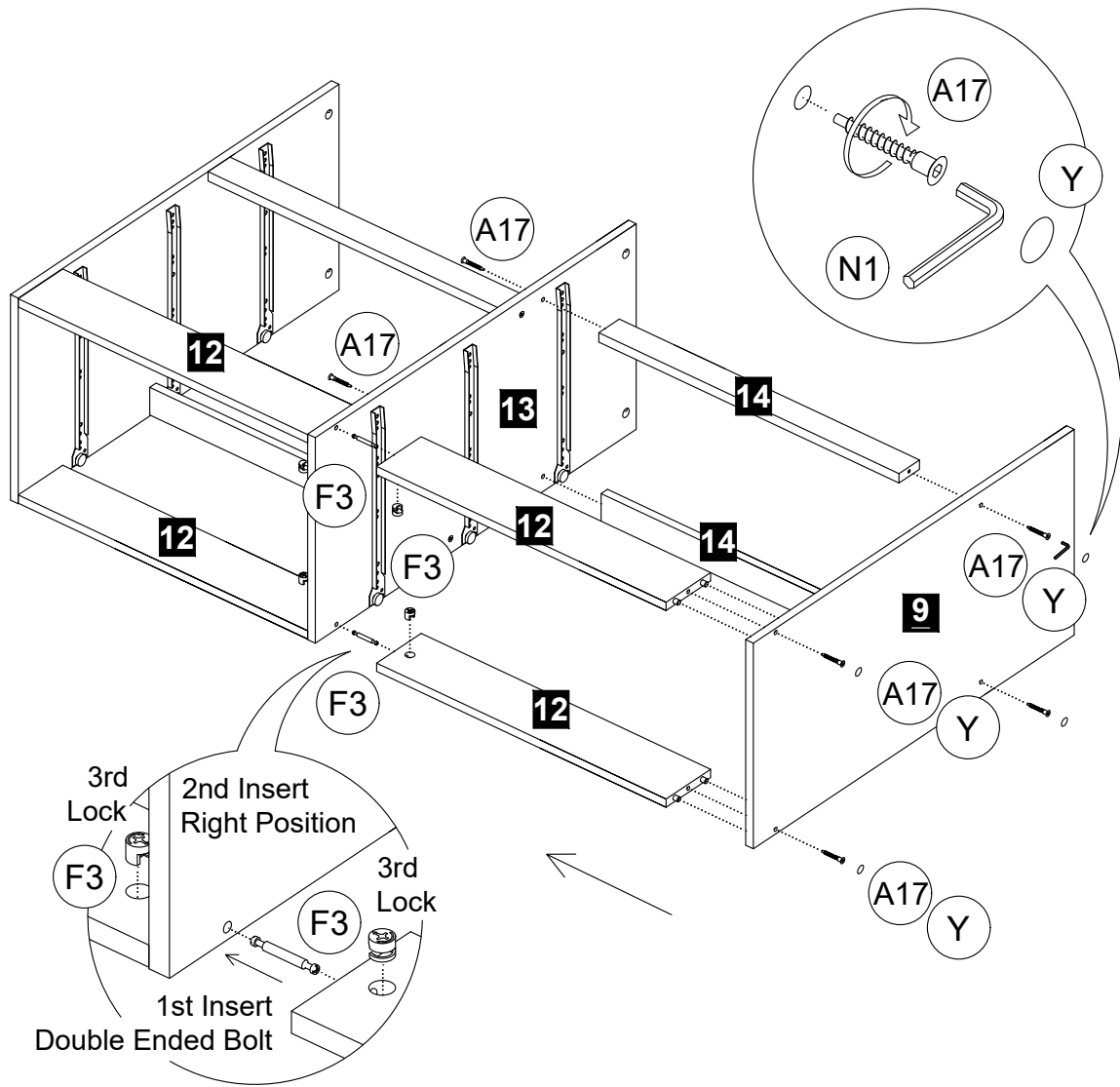

A17		Crosshead Screw m6.3 x 40mm	6 pcs
N1		Allen Key	1 pc
Y		Crosshead Cover	4 pcs

STEP 8

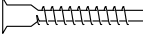
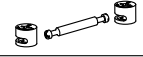

A17		Crosshead Screw m6.3 x 40mm	6 pcs
F3		Mini Fix 64mm (Double End Bolt)	2 sets
N1		Allen Key	1 pc
Y		Crosshead Cover	4 pcs

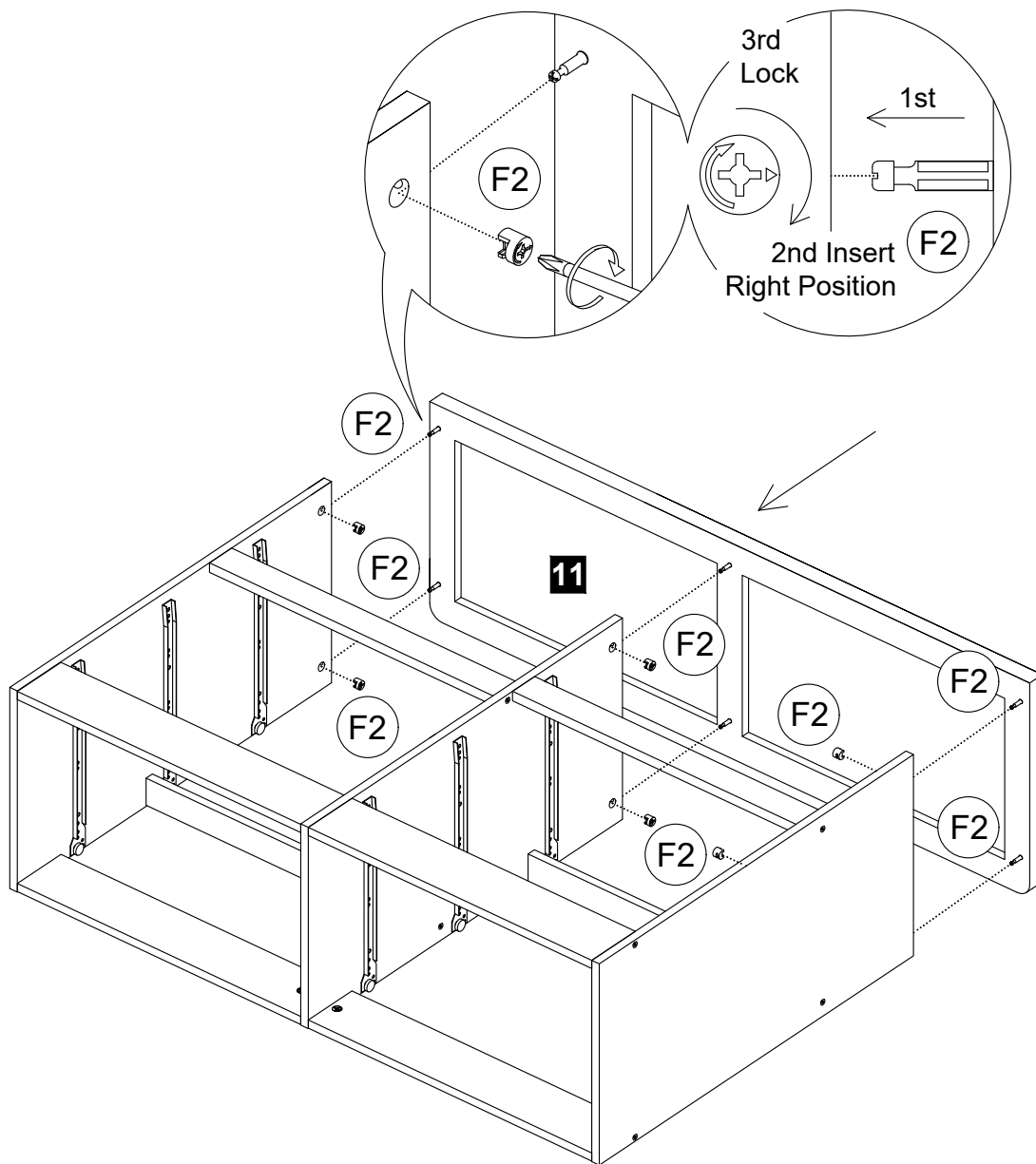

STEP 9

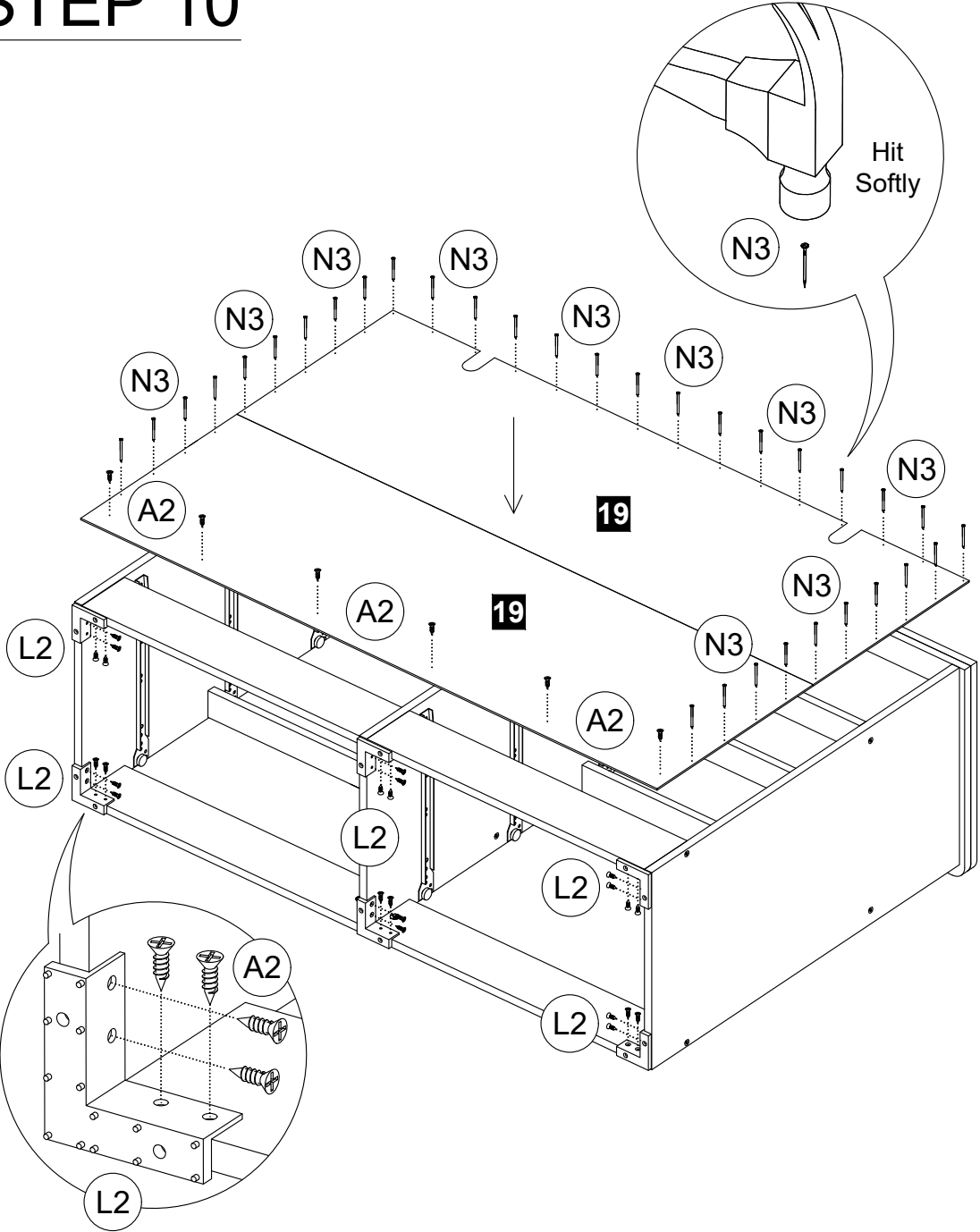

F2		Mini Fix 15mm	6 sets
----	---	---------------	--------

STEP 10





A2		Screw m3.5 x 14mm	30 pcs
N3		Nail	40 (+-3) pcs
L2		Plastic Leg L Shape	6 pcs

STEP 11

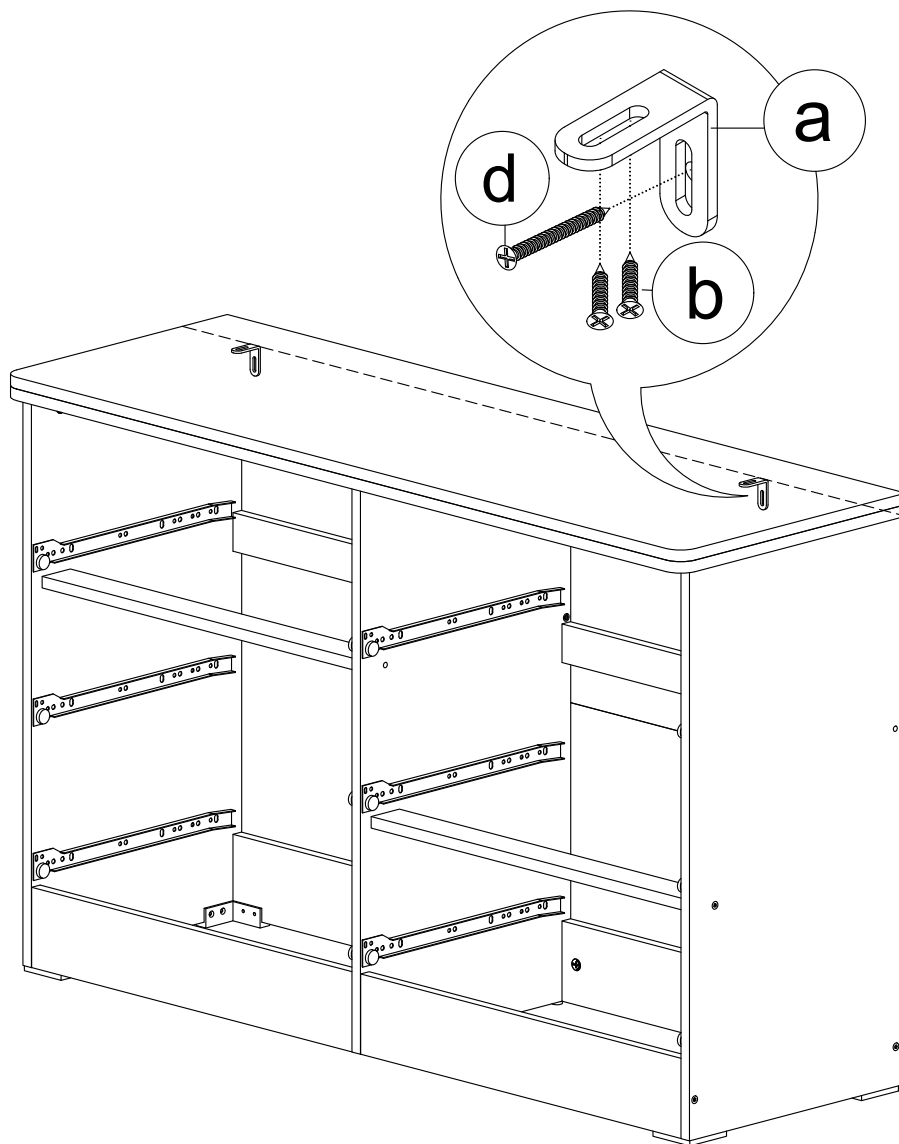
IMPORTANT!
The mounting bracket is placed on the bottom of the top panel .



Stand up

a		Mounting Bracket	2 pcs
b		Screw m3.5 x 20mm	4 pcs
d		Screw m4 x 45mm	2 pcs

STEP 12

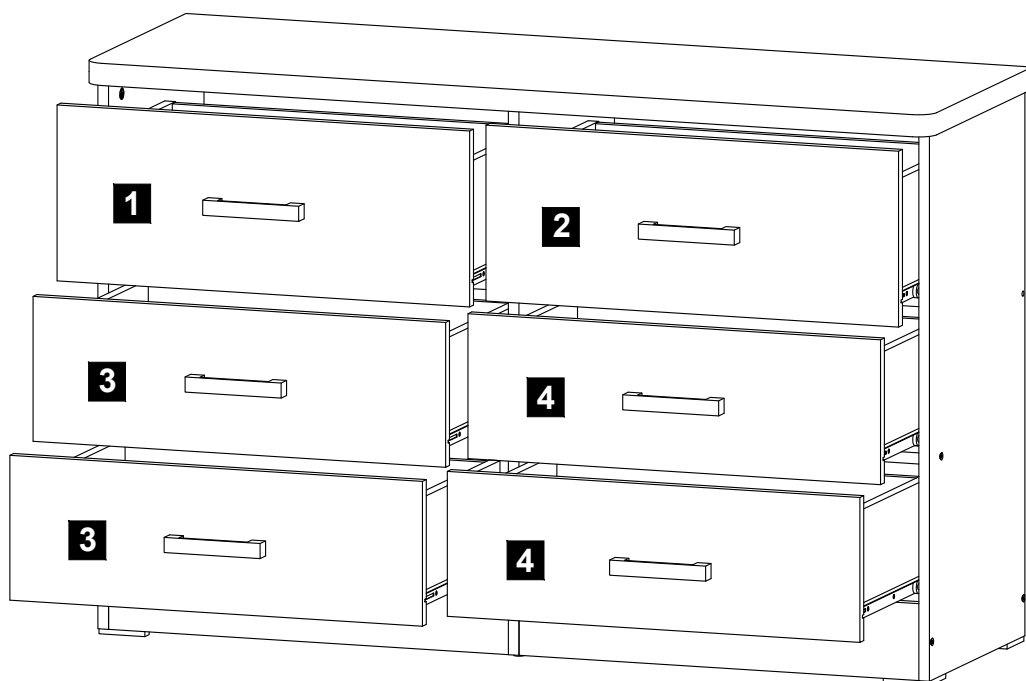

↗
Insert
drawers

FITTING OF TIPOVER RESTRAINT KIT

The Tipover Restraint Kit is highly recommended for this piece of furniture.

(Please take this into extra consideration around young toddlers and children)

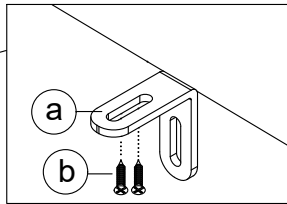
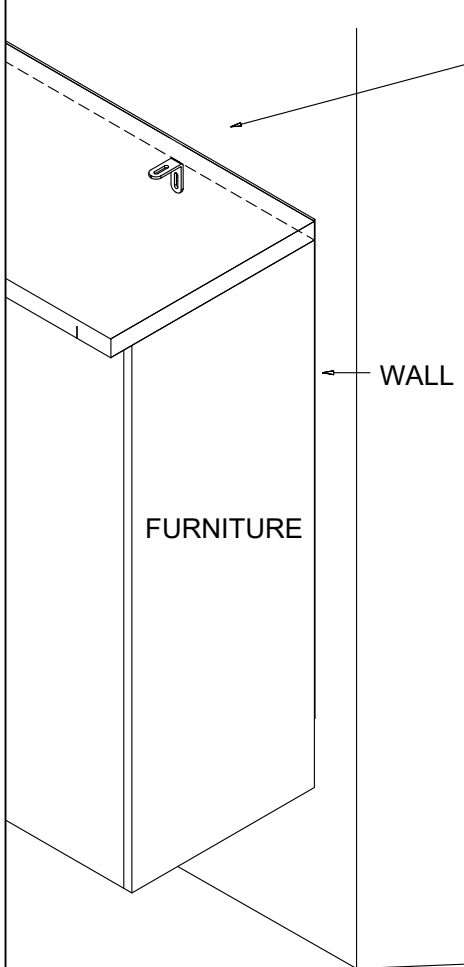

STEP 1:

- Attach the mounting bracket (a) to the bottom top panel near the edge of the side of the unit.
- Screw (b) through the two holes of (a).

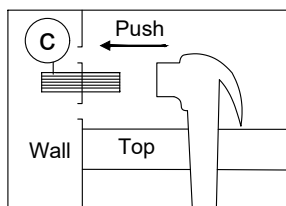

STEP 2:

- Insert the wall plug (d) into the wall behind the unit.

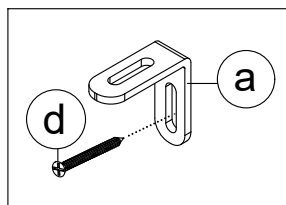

STEP 3:

- Attach to the mounting bracket (a) to the wall plug (c) through the hole by using (d).

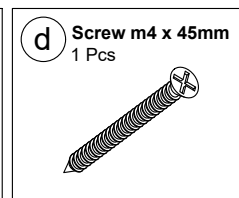
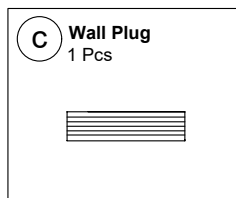
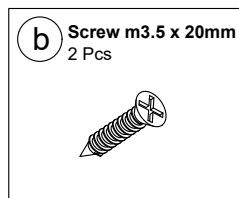
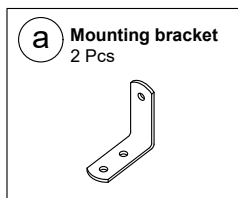

AH CHAI ENTERPRISE SDN BHD
LOT 17334, LORONG ASAS JAYA 3,
KWS PERINDUSTRIAN RINGAN ASAS JAYA,
PERMATANG TINGGI,
14000 BUKIT MERTAJAM, PENANG.
Manufacture Date: 9/12/2023

THANK YOU

We hope you enjoy your new purchase.

We have personally inspected this product.

In the event that you need any additional help for any reason,

Please do not hesitate to contact us at: 315-7580-751 / 973-751-7089

Email lori@shopwp.com

See our website wpfurniture.com

**WP FURNITURE
323 Cortland Street
Belleville New Jersey**

Thank you