

## **Ceiling Fans with Lights product specification**

### **AFTER-SALES SERVICE**

Our team is always stand behind for its products. Customers' satisfaction is our pursuance, forever.

IF the item received damaged, Missing of the accessory, Difficult to install, Or just you don't like it, Please contact us.

We are always ready to service you and help you.

# PLEASE READ THESE INSTRUCTIONS CAREFULLY. FOLLOW ALL INSTALLATION INSTRUCTIONS AND OBSERVE ALL WARNINGS

## WARNING





- **Turn electricity off** at main circuit breaker panel before beginning installation. Thoroughly wash hands after installing.
- Remove the fixture and the mounting package from the box and make sure that no parts are missing by referencing the illustrations on the installation instructions.
- All electrical connections must be in accordance with local and National Electrical Code (N.E.C.) standards. If you are unfamiliar with proper electrical wiring connections obtain the services of a qualified electrician.

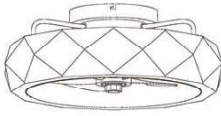
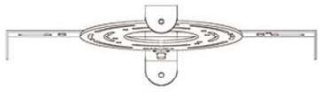

## CAUTION

Please be careful during the handling and installation of the lamps to avoid damaging the products.

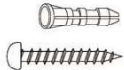
### PART LIST AND ASSEMBLY ILLUSTRATION

Note: Some parts may be pre-installed or pre-assembled

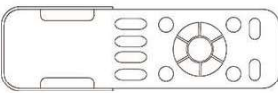
NO	A	B	C	D	E
COMPONENTI					
QUANTITY	1	1	2	4	3

NO	F	G	H			
COMPONENTI						
QUANTITY	1	2	2			

## INSTALLATION STEPS

Please strictly follow the steps in this manual for installation, otherwise there is a risk of damage to the product.

### STEP 1

First, connect the mounting bracket (B) to the electrical junction box.

Connect the junction box and the mounting bracket with screw (C).

Then screw the provided expansion screws (D) into the pre-drilled holes so that the mounting bracket can be fixed to the ceiling.

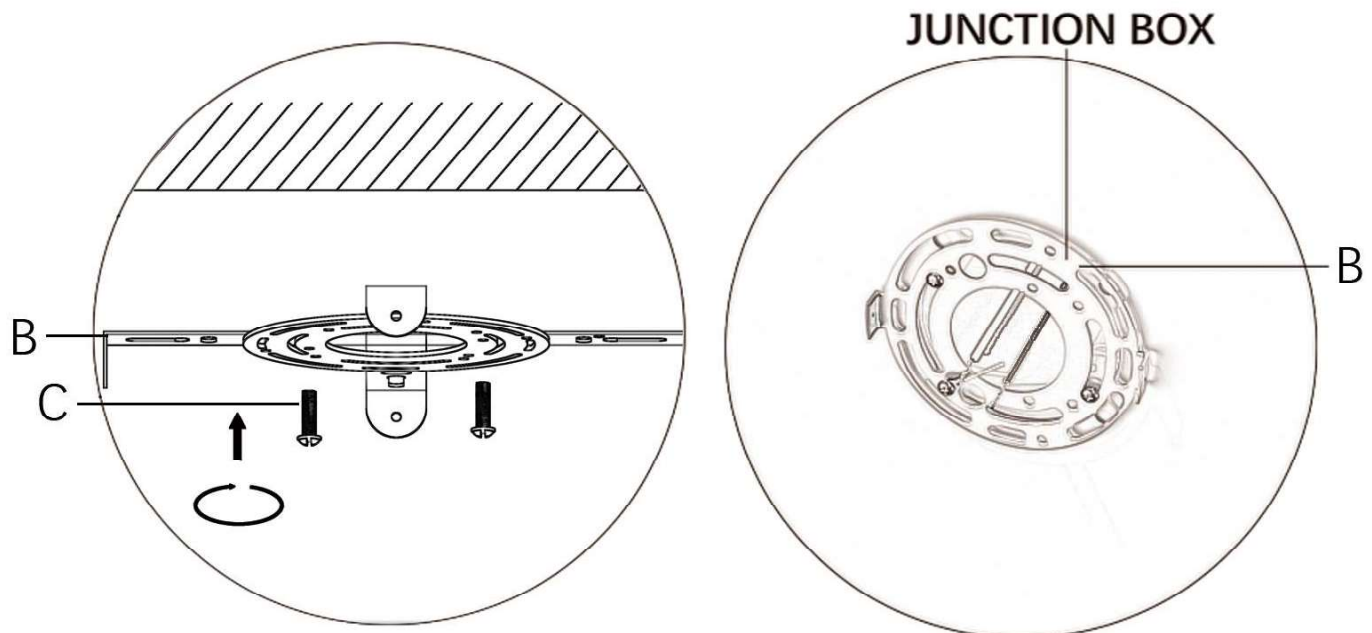

## STEP 2

Make wire connections with wiring cap(E):

Connect the black wire from Fixture to the black supply wire.

Connect the white wire from Fixture to the white supply wire.

Connect the fixture ground wire to the supply ground wire with a wiring cap.

You can use gasket (H) for the connection process of the ground wire.

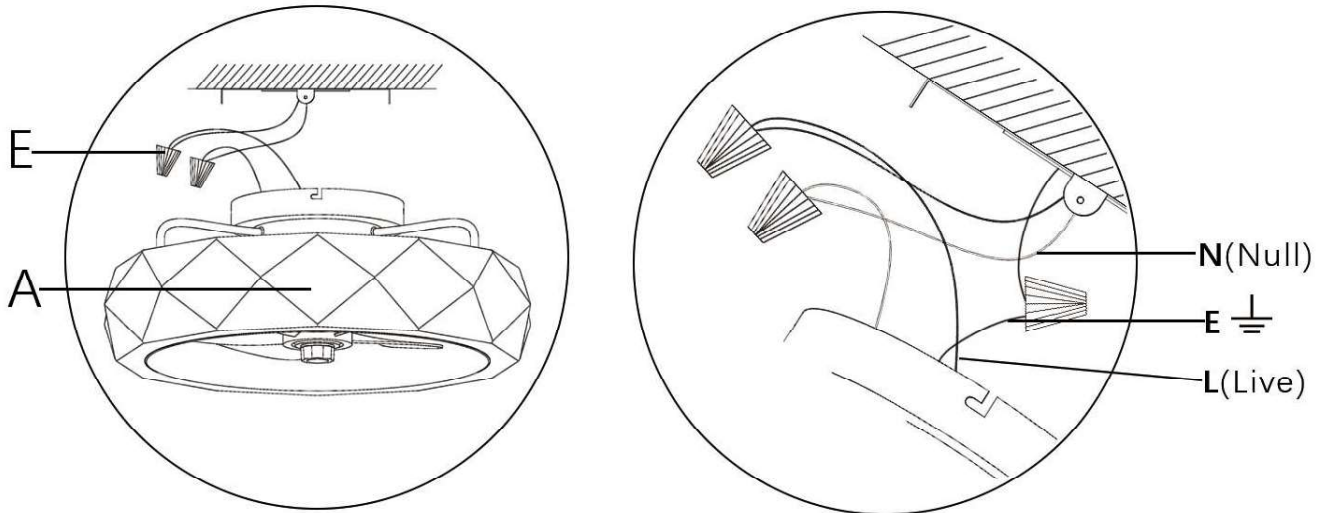

## STEP 3

Align the fan-light(A) with the installed mounting bracket (B), and secure it by rotating the assembly until it locks firmly into place.

Fasten the mounting bracket(B) to the fan-light(A) with screws (C) on both sides. Finally check all connections to ensure everything is securely in place.

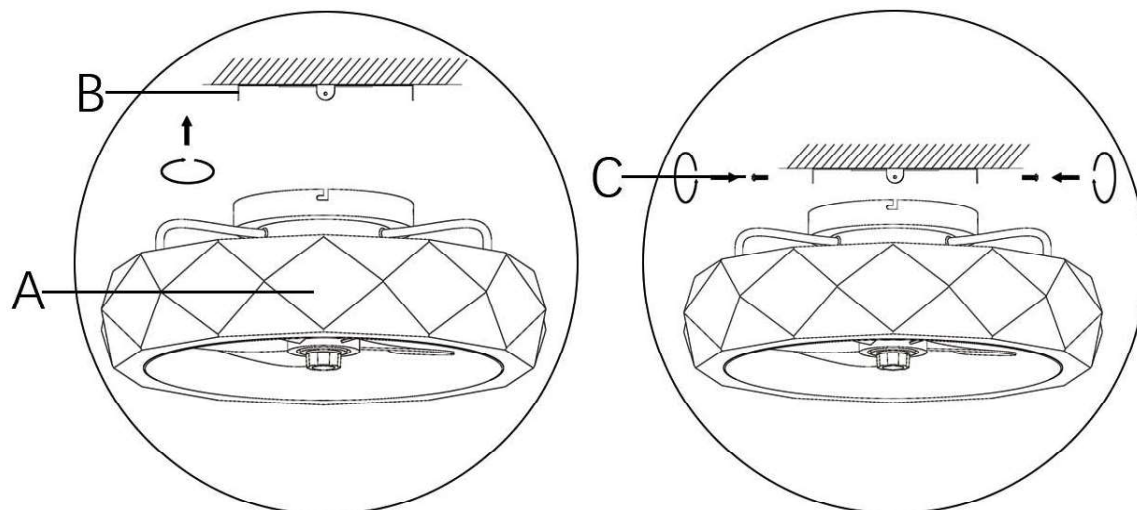

## STEP 4

### Operating Your fan-light

1.You can control the fan light with a remote control. By fixing the remote control stand to the wall with an expansion screw(G), it will be more convenient to take out the remote control.

2.You can also control the fan light remotely via your mobile phone by downloading the app.

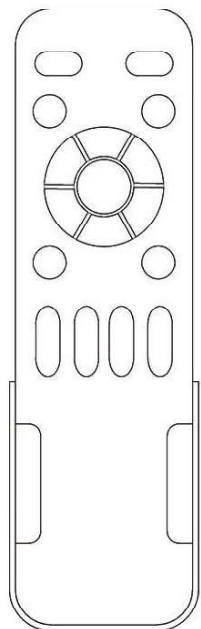

### Download and install App

1.Open the QuickControl App, click "+ " Add Device in the upper right corner, and wait for the App to automatically search for peripheral devices; (Make sure the device is powered on and turned on.)

2.After the App scans the device, click Add to finish the device;

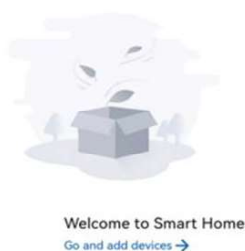
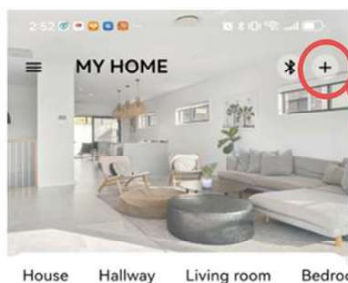

3. Click Done to enter the device control page

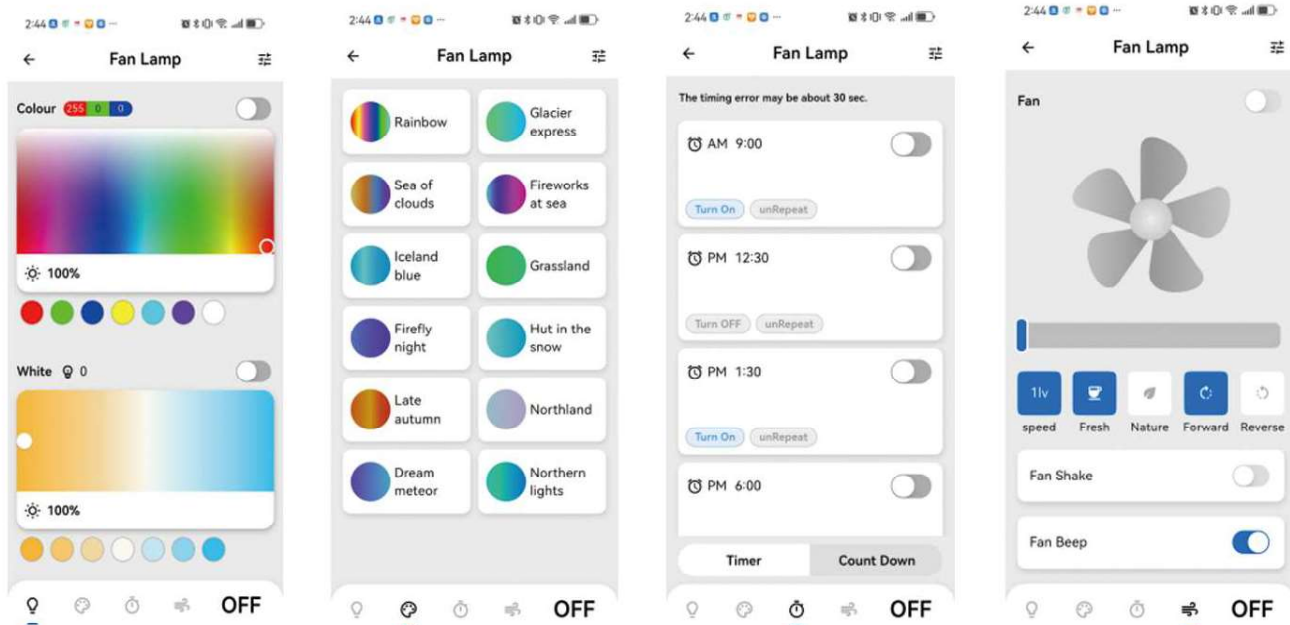

## ENDOTE

If you have questions about electrical installation, consult a qualified electrician or contact our after-sales service center