

Warranty

Our office chair comes with a 1- year warranty from the date of purchase.
In any circumstance that the product arrives damaged or missing parts.
We are more than happy to provide you with replacement part.

Warm tips

Please read the instructions carefully before assembly and
make sure you have the parts & hardware as identified on the list.

It is highly recommended to assemble the chair on a
soft clean surface to avoid scratches.

Modern Home Office Chair



PARTS LIST

1 Backrest



2 Seat Cushion



3 Mechanism

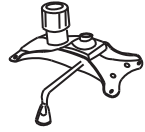

4 Gaslift

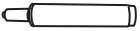

5 Base Legs

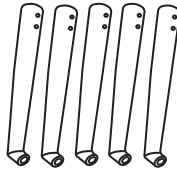

6 Base

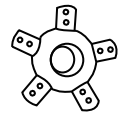

7 Castors



8 Armrest

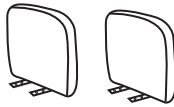

Hardware Kit

A1 Small Bolts(M6*12mm)



10

A2 Big Bolts(M6*25mm)

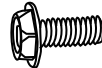

8

A3 Big Bolts(M6*18mm)



4

A4 Big Bolts(M6*30mm)



4

B Allen Key



1

Step 1:

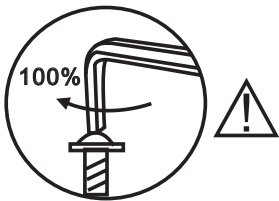
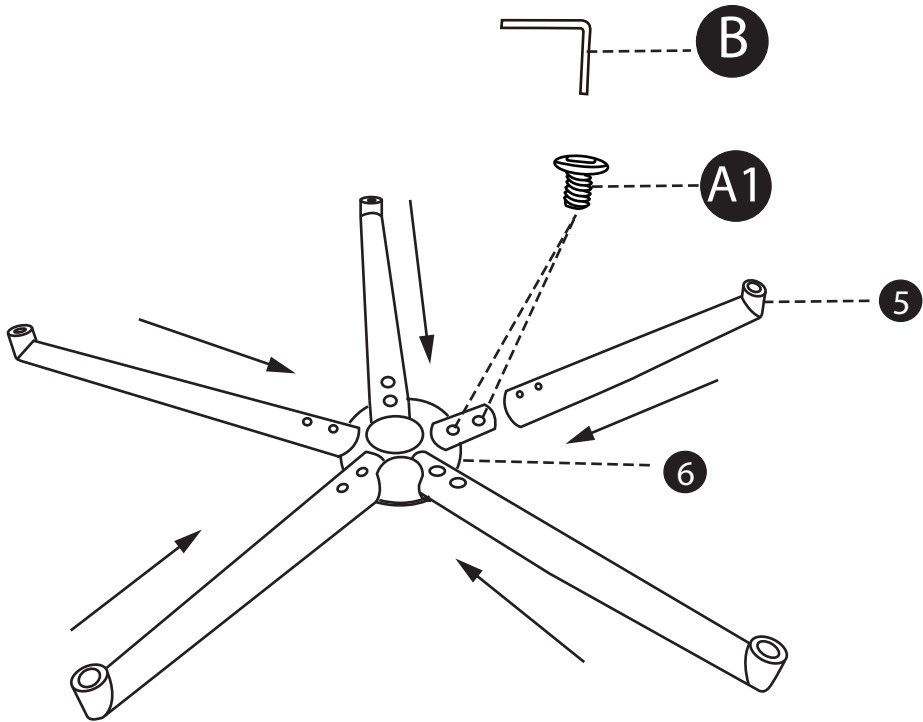

Step 2:

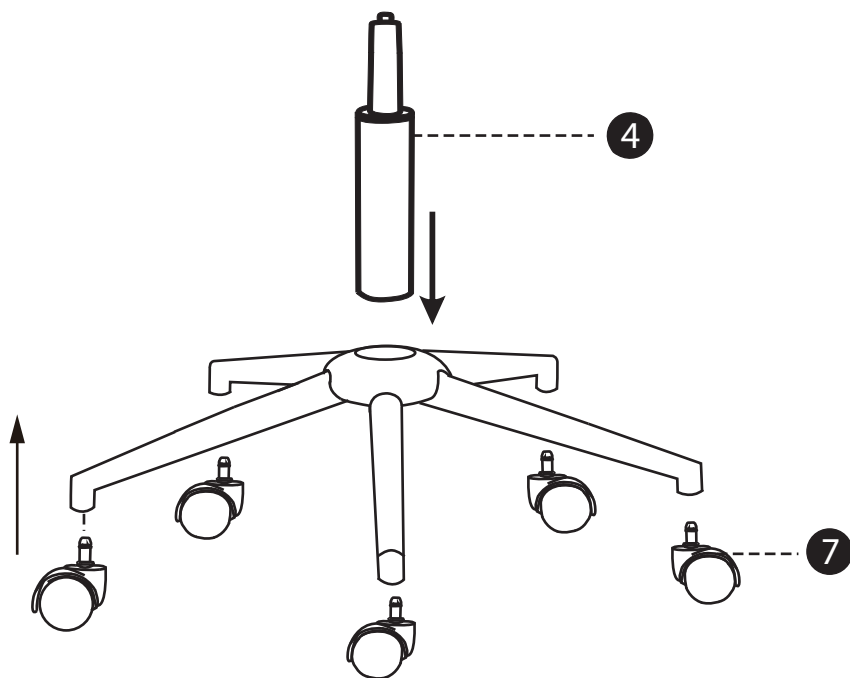

Step 3:

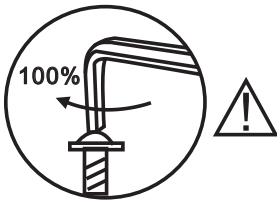
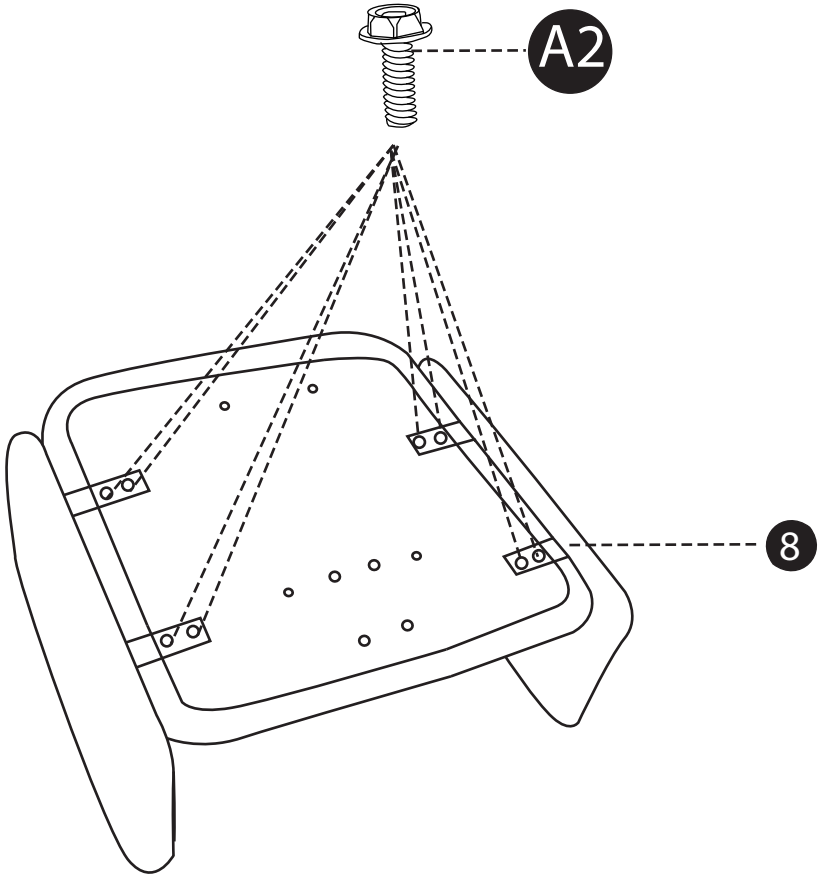

Step 4:

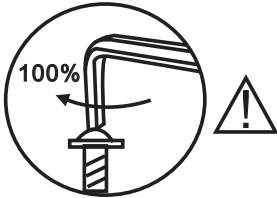
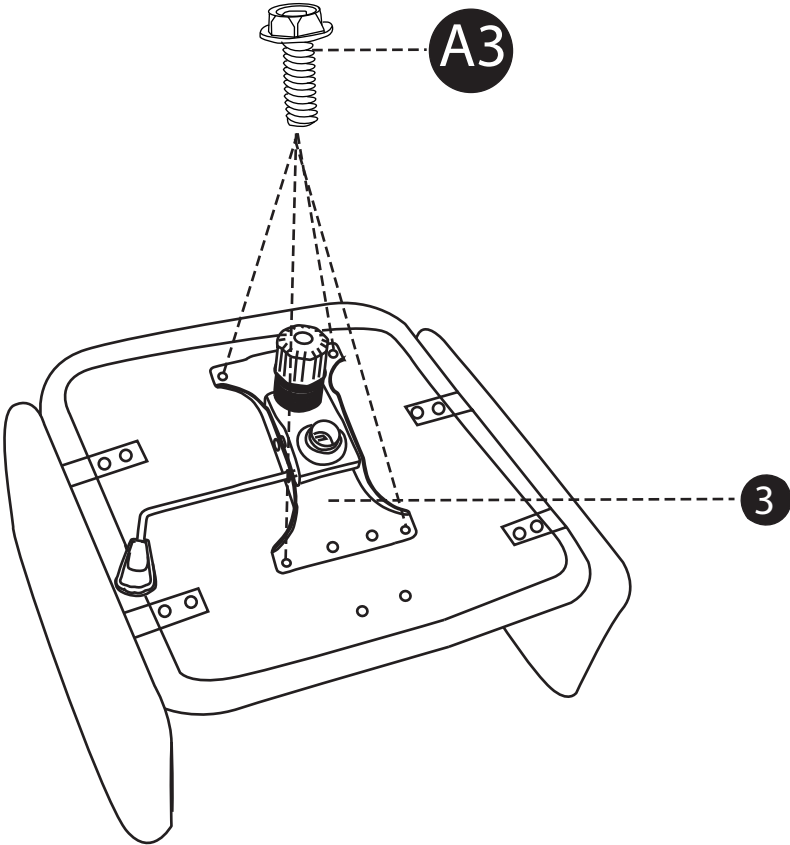

Step5:

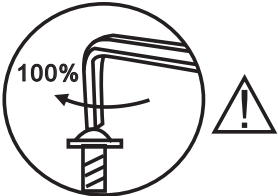
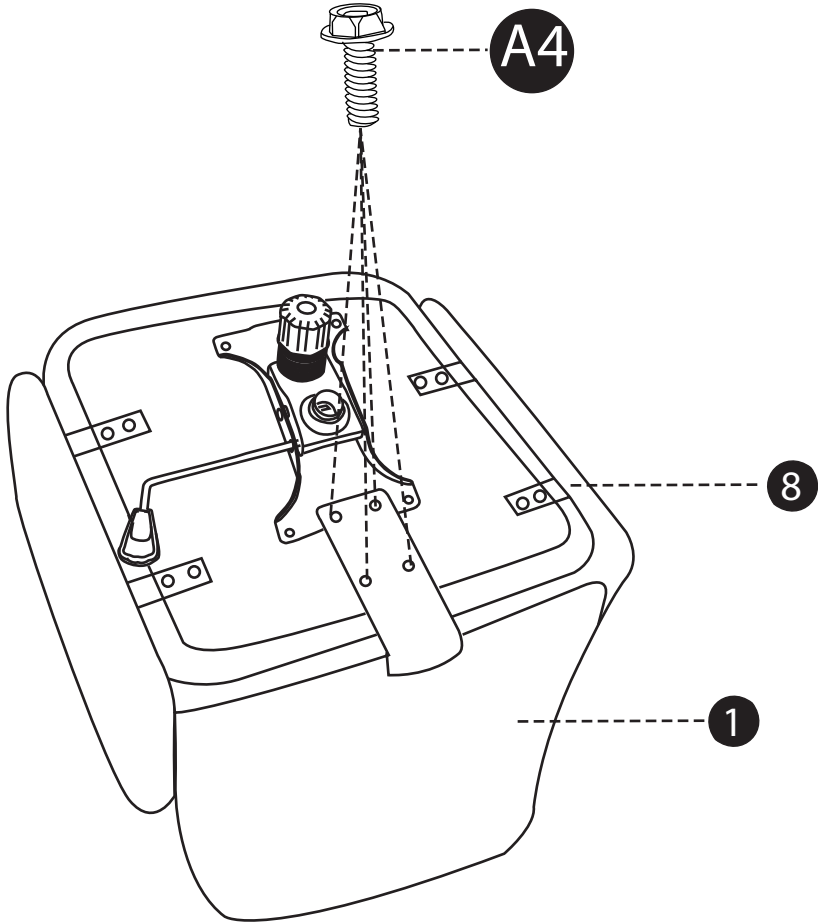

Step 6:

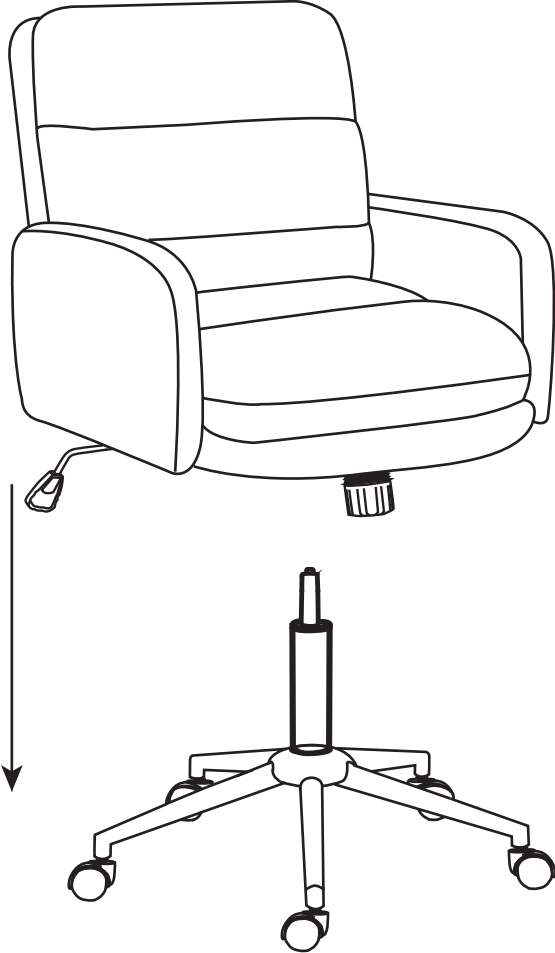

Step 7:

