

OWNER MANUAL

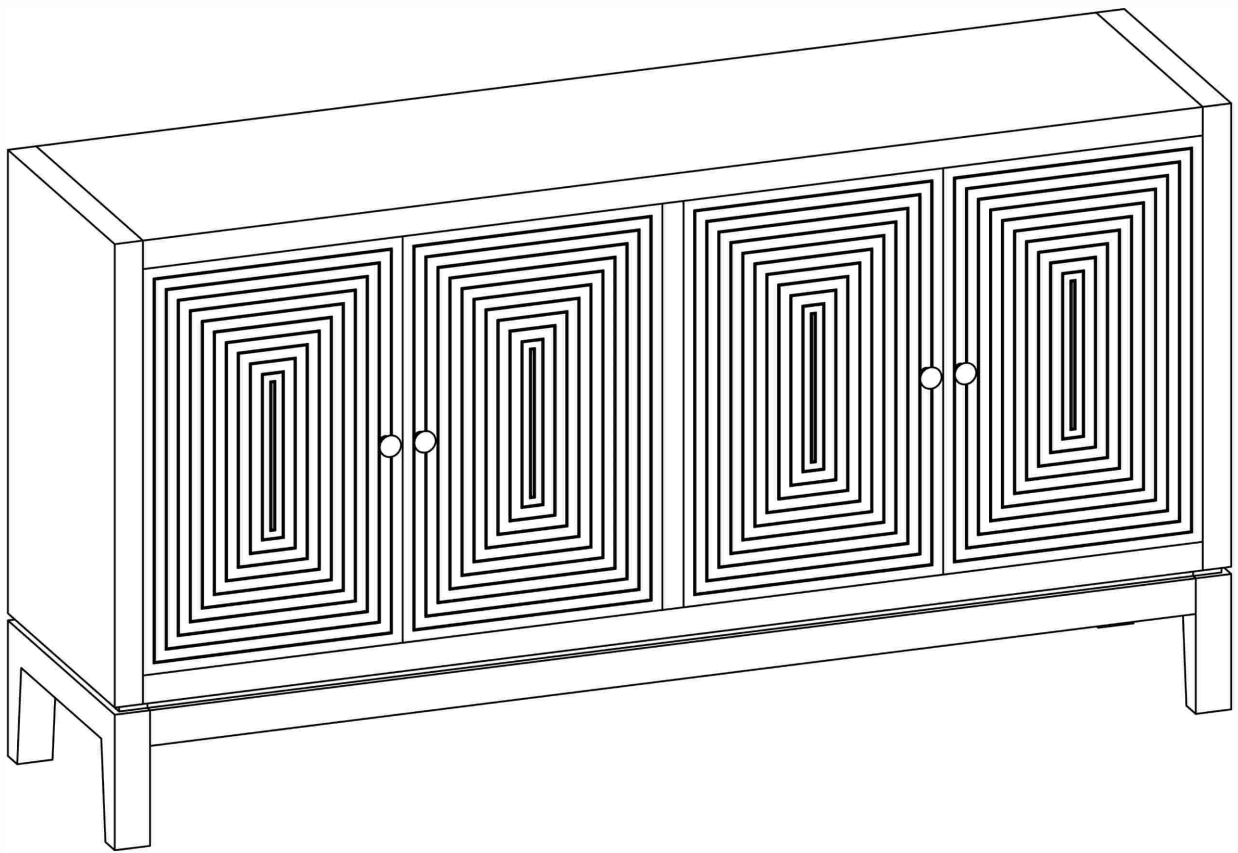

- 1.Note:This is not clothing storage cabinet and it is not recommended to use it as a clothing storage cabinet.
- 2.All cabinets come with TRO,stainless steel or our “L-Bracket“when shipped.

1. Thank you for choosing ***our products.***

2. Return Policy



DO NOT RETURN TO THE STORE! Skip the process of returning your product and contact us directly for a replacement

If you find that parts of your order are missing or damaged, we will gladly ship any needed replacement parts free of charge.

If your product's quality does not meet your expectations or you have found any sort of defect, please contact our customer service department and let us know the details of your order and any issues encountered, we will try our best to provide you with a solution. Feel free to also directly contact our manufacturer concerning needed replacement parts and they will be happy to help provide you with a solution or answer any questions you may have.

Recommendations Before Beginning Assembly



• Read instructions, cover to cover



• Have 2-4 adults on hand for assembly depending on product size



• Do not assemble directly on flooring or carpet



• Assemble on a clean non-marring surface (example: packing foam)













• Save all packaging until finished

3. Assembly Notice:

- If you encounter any problems during assembly and find that you cannot continue, rest assured we will help you solve the situation as soon as possible. Simply keep all of the parts of the product stored in a safe place and contact us immediately so we may assist you further.
- Once you have opened your package, remove all inner hardware packages and take the parts out. One by one, Place the parts out neatly in front of you, then refer to the instructions to ensure no parts are missing. If any pieces are found missing, please carefully look in the box first, as the hardware packaging might have torn making the hardware spill in the box.

- Some key parts of your product may be stored and hidden inside of other parts. Please open any zippered or hook & loop storage compartments to remove all parts. (example: cushions and legs being stored in the underside of a sofa)
- **IMPORTANT:** When setting up your product, **DO NOT INSTALL THE SCREWS ALL THE WAY IN THE BEGINNING.** Place each screw into their proper hole and use your hand to twist the screw halfway. Twist all the screws in halfway to ensure the holes will match up properly and the product is level on the ground. When everything seems fitted, then tighten the screws.
- When you have completed assembly, we suggest you have more than one person to assist you with lifting and placing the product.

Care & Maintenance

- ⊘  ● Do not put hot items directly on furniture surface
- ⊘  ● Do not clean furniture with harsh cleansers or polish
- ⊘  ● Do not place furniture under direct sunlight
- ⊘  ● Do not place furniture near heating or cooling vents
- ⊘  ● Do not write on furniture without a padded barrier to protect the surface
- ⊘  ● Do not place furniture outside. For indoor use only
- ⊘  ● Not for commercial use. For residential use only
- ⊘  ● Stains may be removed with mild soap solution and damp cloth
- ⊘  ● Children should not climb or jump on the furniture
- ✓  ● Dust and pick-up spills using a clean, non-colored, lint-free cloth

Caution

- This product contains small components. Please ensure that they are kept away from small children.
- Do not use power tools to assemble your furniture. Power tools may strip or damage the parts.

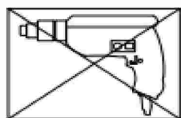



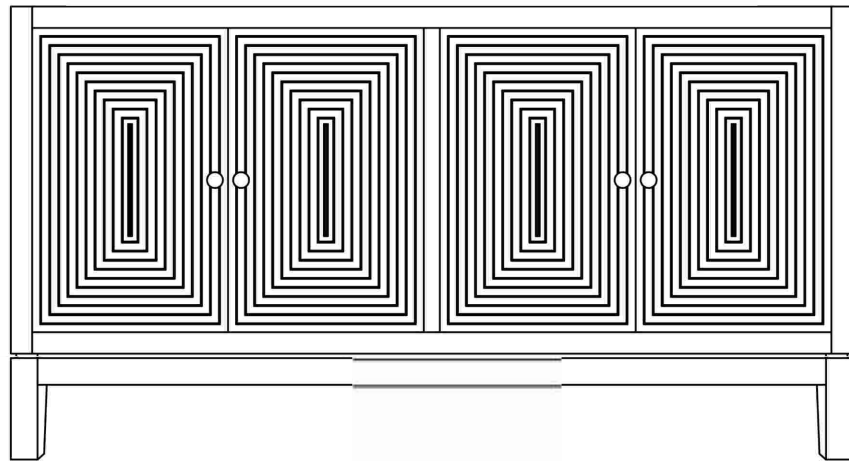



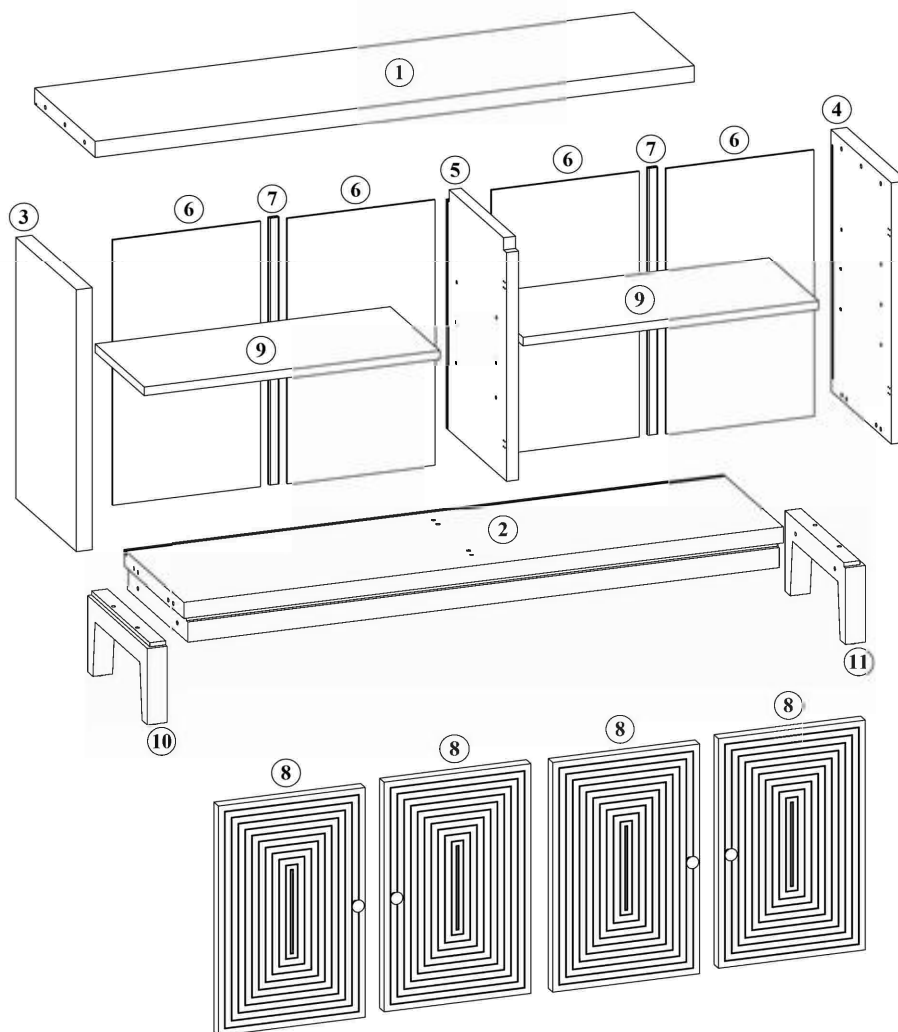



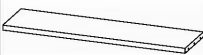

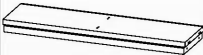

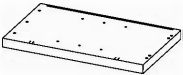















SKU: JNY11P205933



Part list





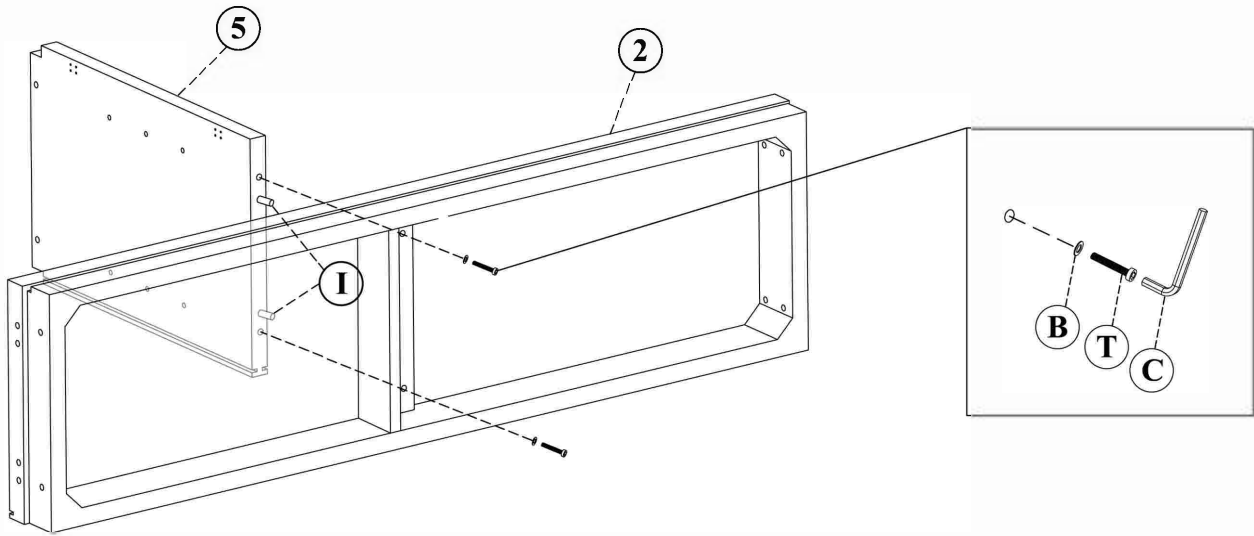

TWO CARTONS /HARDWARE LIST

PART LISTS				HARDWARE LIST			
NO	DESCRIPTION	SKETCH	Q'TY	NO	DESCRIPTION	SKETCH	Q'TY
①	TOPFRAME		1 PC	Ⓐ	BOLT Ø6*35mm		8PCS
②	BOTTOM FRAME		1 PC	Ⓑ	FLAT WASHER Ø16*1mm		24PCS
				Ⓒ	ALLEN KEY Ø4*60mm		1 PC
③	LEFT FRAME		1 PC	Ⓓ	HANDLE		4PCS
④	RIGHT FRAME		1 PC	Ⓔ	BOLT Ø3*28mm		4PCS
				Ⓕ	HINGER		8PCS
⑤	CENTERE PANEL		1 PC	Ⓖ	PAD		4PCS
⑥	BACK PANEL		4PCS	Ⓗ	BOTTON		4PCS
				Ⓘ	STOPPER		10 PCS
⑦	STRIP		2PCS	Ⓝ	IRON		2PCS
				Ⓚ	SCREW Ø3.5*16mm		52PCS
⑧	DOORS		4PCS	Ⓛ	SCREW Ø3*14mm		8PCS
				Ⓜ	SHELF PIN		8PCS
⑨	SHELF		2PCS	Ⓝ	PLOSTIC BTTON		8PCS
⑩	LEFT LEG		1 PC	Ⓞ	NUT		2 PCS
⑪	RIGHT LEG		1 PC	Ⓟ	PLASTC STRAP		2 PCS
				Ⓠ	SCREW Ø5*14mm		2PCS
				Ⓐ	SCREW Ø4*35mm		2 PCS
				Ⓢ	BOLT Ø6*45mm		4PCS
				Ⓣ	BOLT Ø6*40mm		6PCS





STEP 1

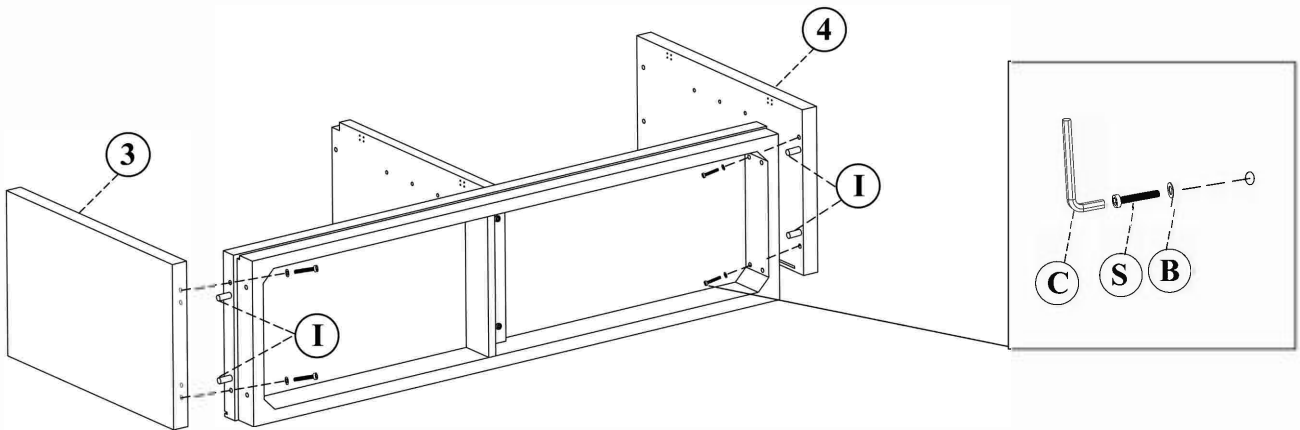

T Q'ty : 2pcs	B Q'ty : 2pcs	C Q'ty : 1pc	I Q'ty : 2pcs
 Ø6*40mm	 Ø16*1mm		





STEP 2

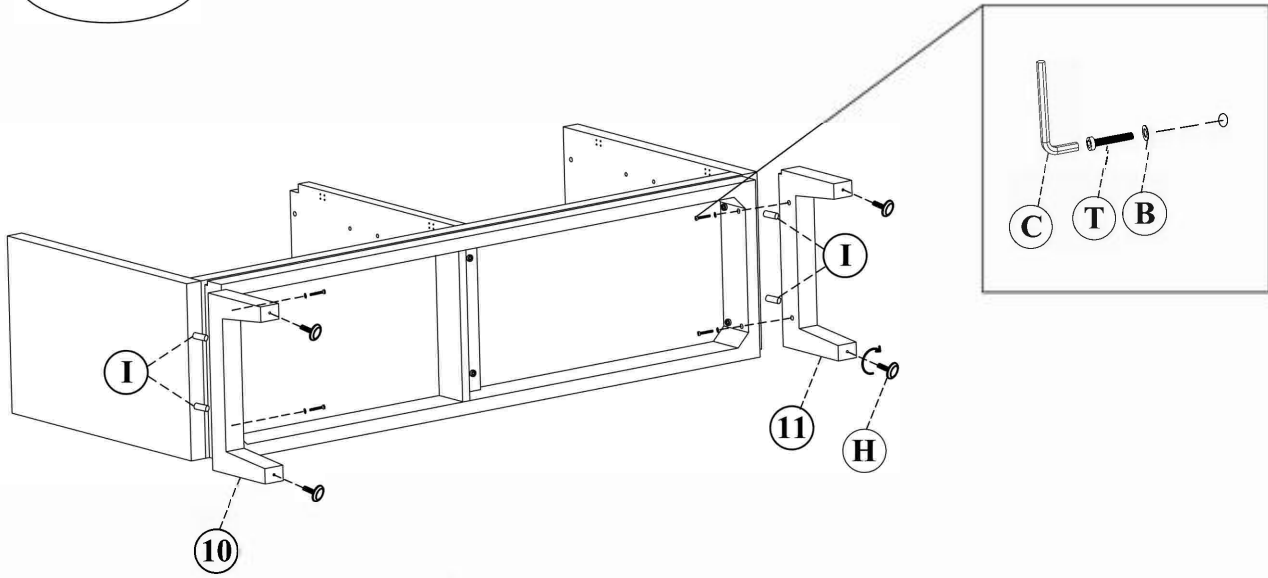

S Q'ty: 4pcs	B Q'ty: 4pcs	C Q'ty: 1pc	I Q'ty : 4pcs
 Ø6*45mm	 Ø16*1mm		

STEP 3



T	Q'ty : 4pcs	B	Q'ty : 6pcs	C	Q'ty : 1pc	H	Q'ty : 4pcs	I	Q'ty : 4pcs
									
	Ø6*40mm	Ø16*1mm							

STEP 4

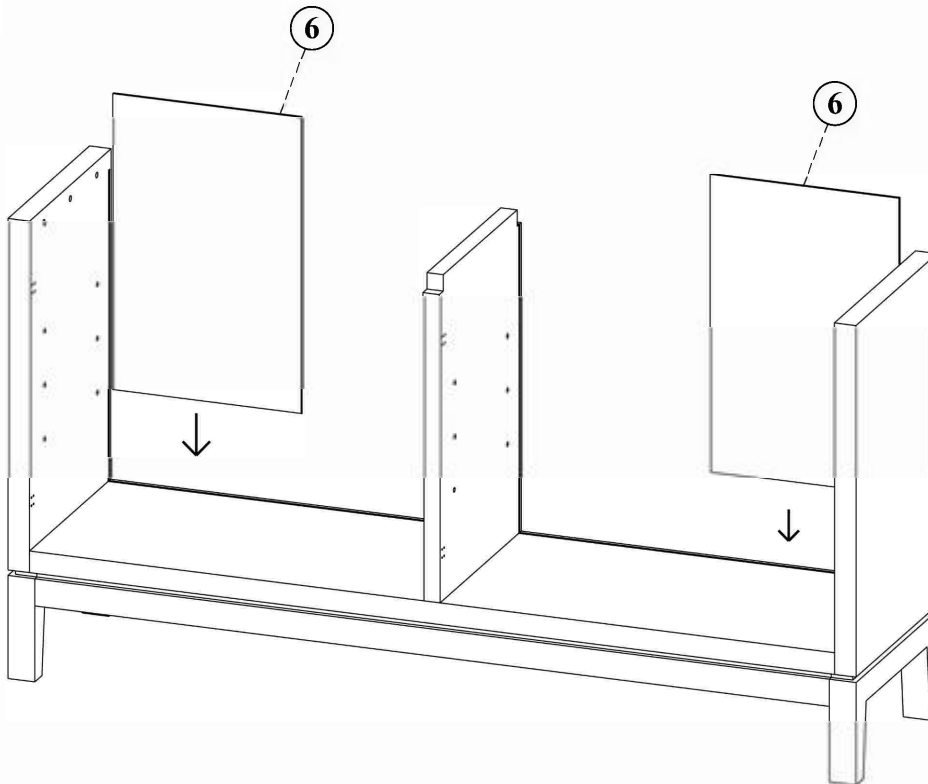

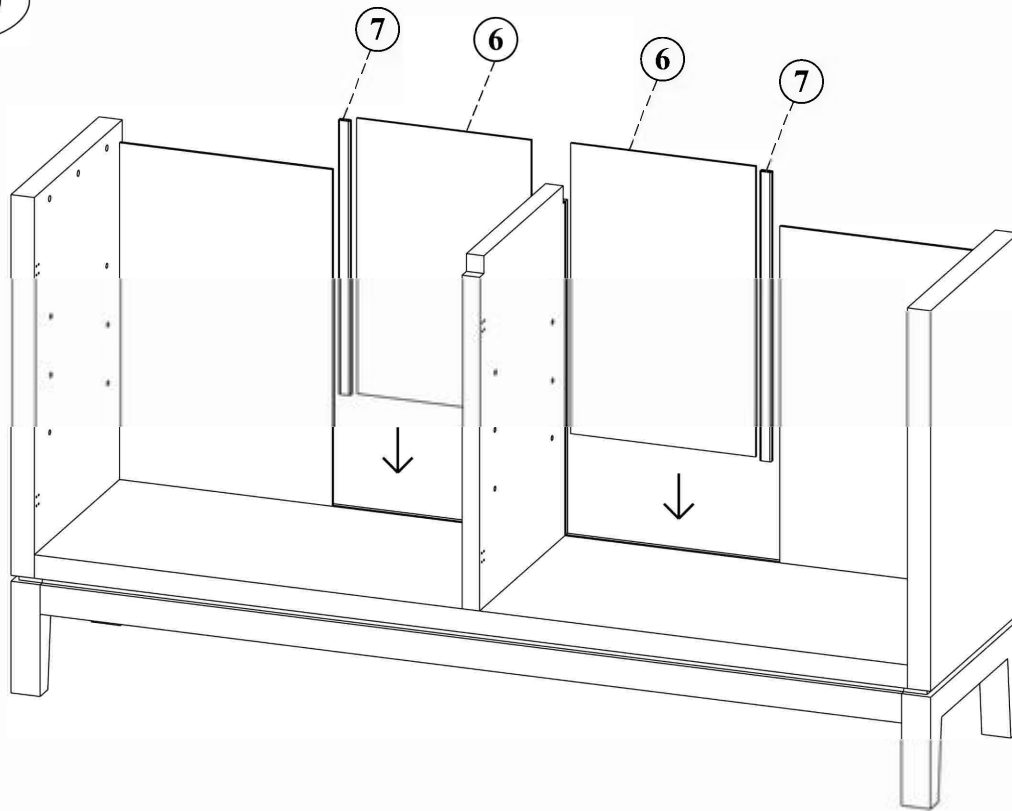

STEP 5



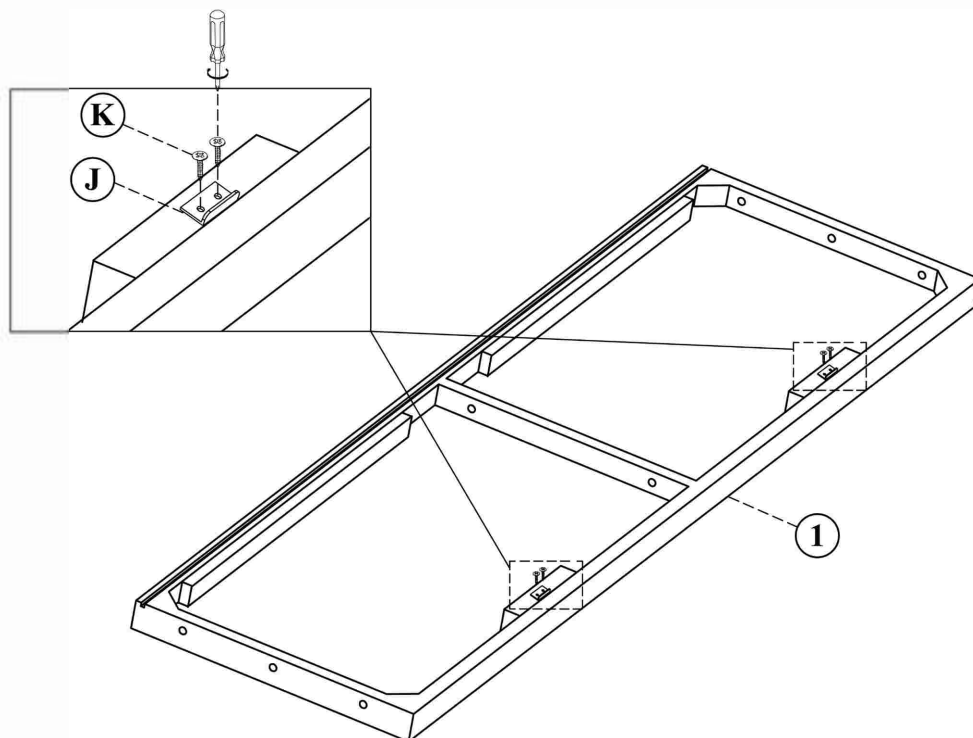



STEP 6

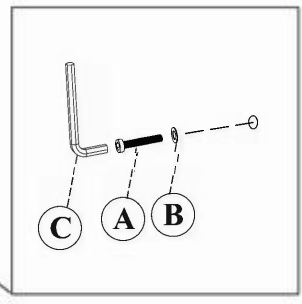
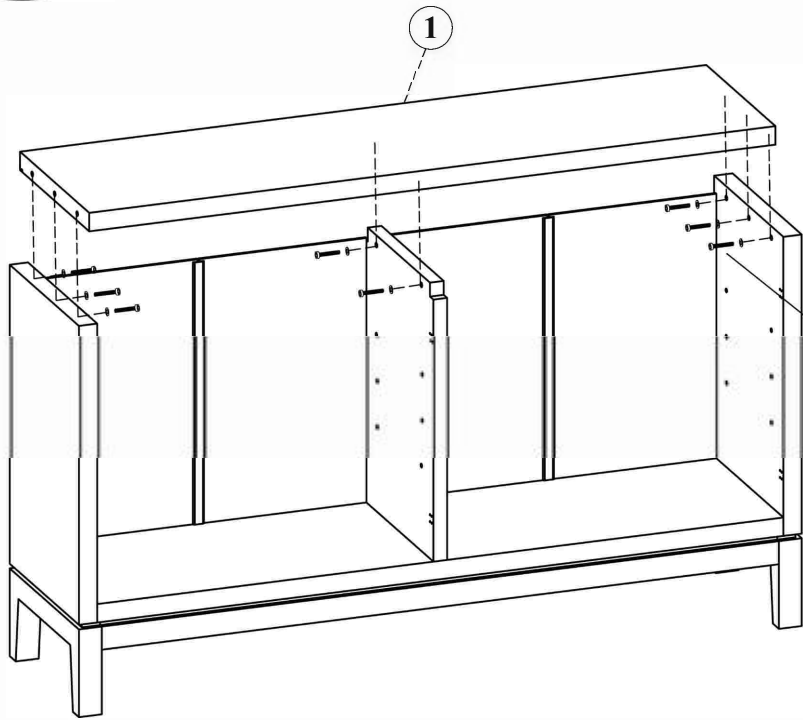

J Q'ty: 2pcs	K Q'ty: 4pcs
	 Ø3.5*16mm

STEP 7



A Q'ty: 8pcs	B Q'ty: 8pcs	C Q'ty: 1pc
 Ø6*35mm	 Ø16*1mm	



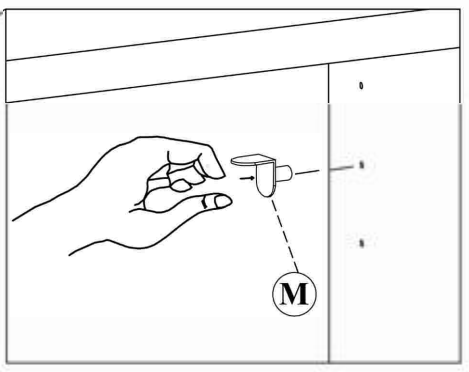
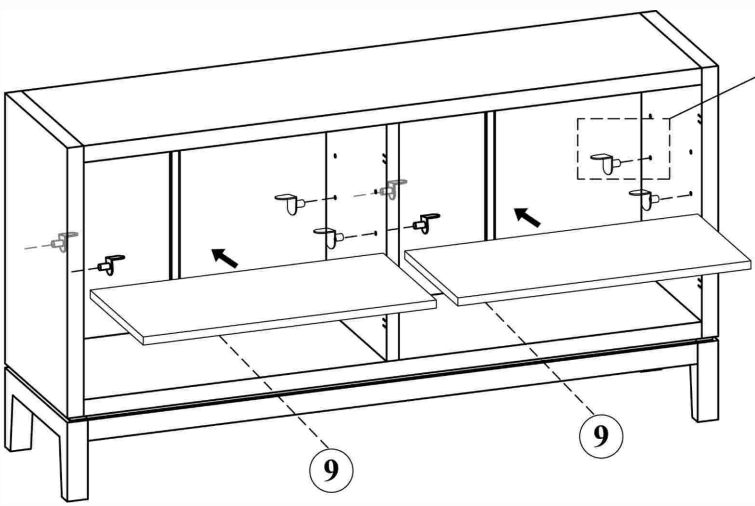

STEP 8

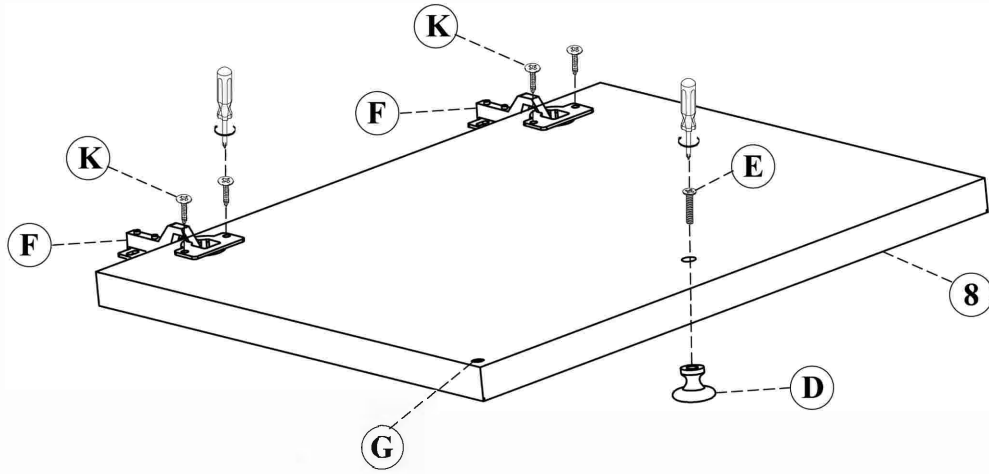

M Q'ty: 8pcs

STEP 9 X4



D Q'ty : 4pcs	E Q'ty : 4pcs	F Q'ty : 8pcs	K Q'ty : 16pcs	G Q'ty : 4pcs
	 Ø3*28mm		 Ø3.5*16mm	

STEP 10

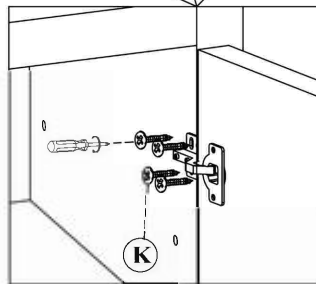
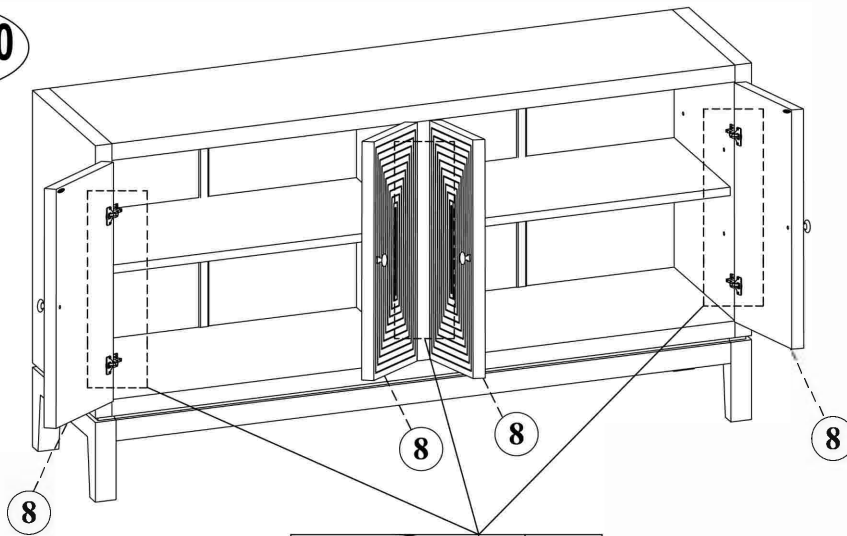



Note: Please assemble the door according to the installation steps first. If the cabinet door is deviated, the internal hinge needs to be slowly adjusted to solve the problem.

K Q'ty: 32pcs
 Ø3.5*16mm

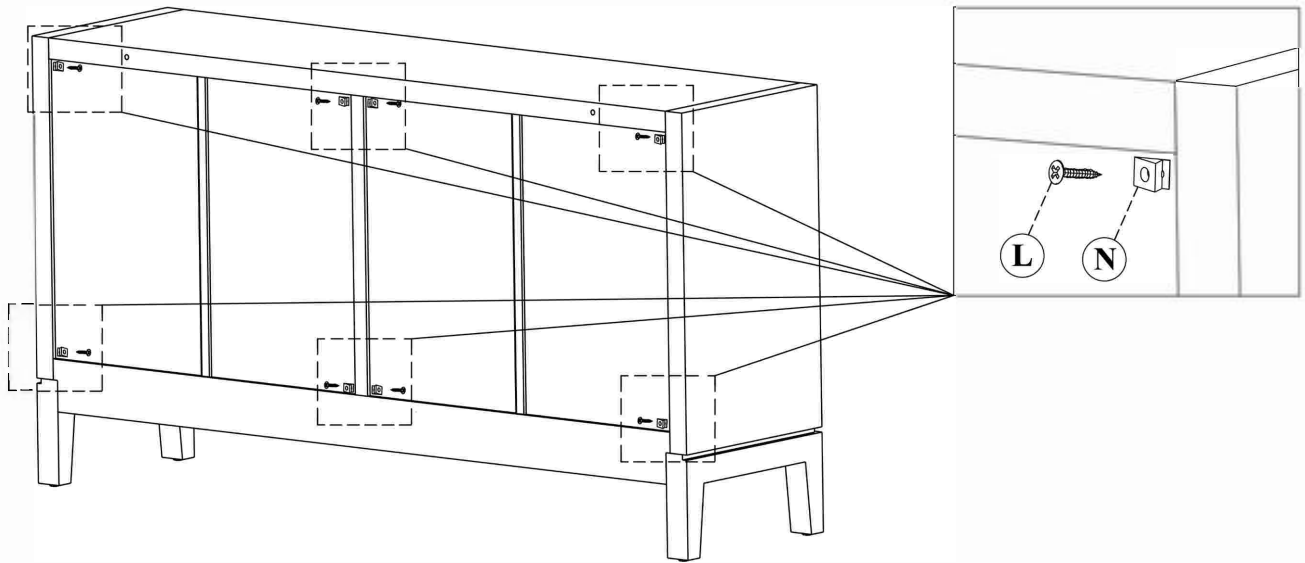



STEP 11

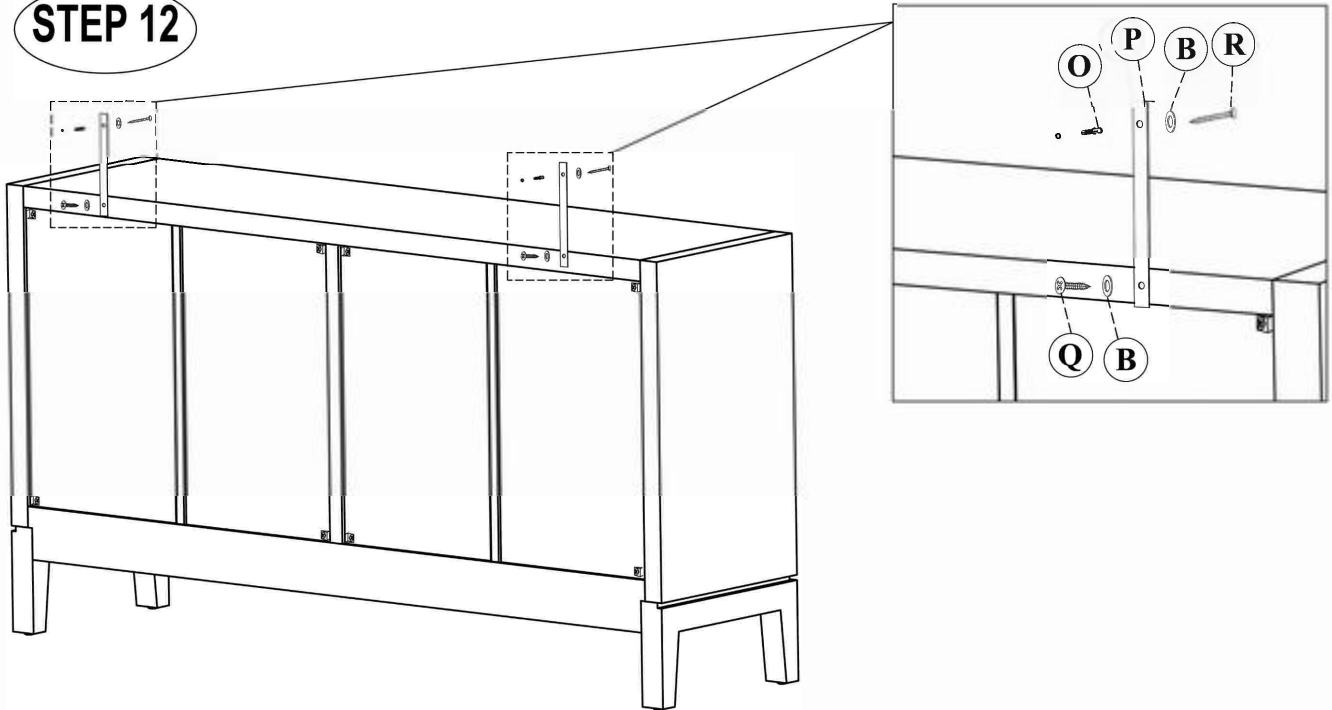

L	Q'ty: 8pcs	N	Q'ty: 8pcs
			
Ø3*14mm			

STEP 12

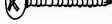

O	Q'ty: 2pcs	P	Q'ty: 2pcs	Q	Q'ty: 2pcs	R	Q'ty: 2pcs	B	Q'ty: 4pcs
									
				Ø5*14mm	Ø4*35mm		Ø16*1mm		