



ASSEMBLY INSTRUCTION

RECLINING CHAIR

| NO. | PARTS LIST | QTY | DESCRIPTION |
|-----|---|-----|-------------|
| A |  | 1 | SEAT |
| B |  | 1 | BACK REST |

| NO. | HARDWARE LIST | QTY | DESCRIPTION |
|-----|---|-----|-------------|
| C |  | 1 | LSF EAR |
| D |  | 1 | RSF EAR |

Step 1 # Align the femal metal bracket at the back onto the male metal bracket at the seat, insert back rest to the seat then push to the end and make sure it is fixed in position securely.
 Step 2 # Align the metal bracket at the ear onto the male metal bracket at the back rest, push the ear down and make sune it is fixed in position securely.

STEP 1

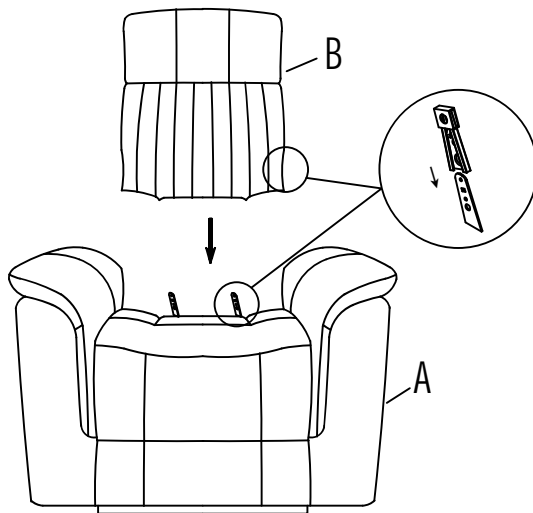

STEP 2

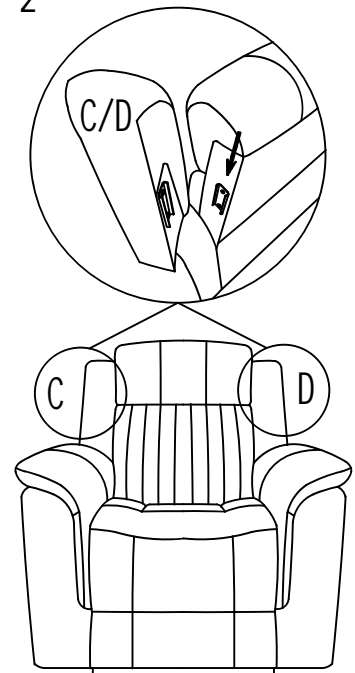

STEP 3 Completed

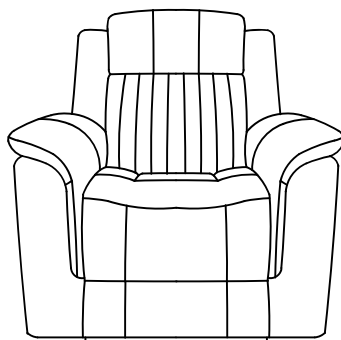

CARE INTRUCTION POLYESTER FURNITURE

In order to maintain the original appearance of your polyester furniture, please follow below simple care procedures.







°Avoid exposing polyester furniture directly to sunlight or heating and air conditioning outlets. Exposure to sunlight or heating and air conditioning outlets will fade/damage polyester furniture.

°Wipe gently with a damp soft cloth to remove dust , dirt and any grime build up.

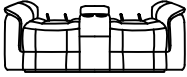
ASSEMBLY INSTRUCTION

DOUBLE RECLINING LOVE SEAT WITH CENTER CONSOLE

CONSOLE BACK REST IS STORED IN THE BOTTOM OF THE SEAT, PLESAE TAKE OUT FOR ASSEMBLY.

| NO. | PARTS LIST | QTY | DESCRIPTION |
|-----|---|-----|-------------------|
| A |  | 1 | SEAT |
| B |  | 1 | LSF BACK REST |
| C |  | 1 | RSF BACK REST |
| D |  | 1 | CONSOLE BACK REST |
| E |  | 1 | LSF EAR |
| F |  | 1 | RSF EAR |

| NO. | HARDWARE LIST | QTY | DESCRIPTION |
|-----|--|-----|-------------|
| G |  | 2 | BOLT |

STEP 1

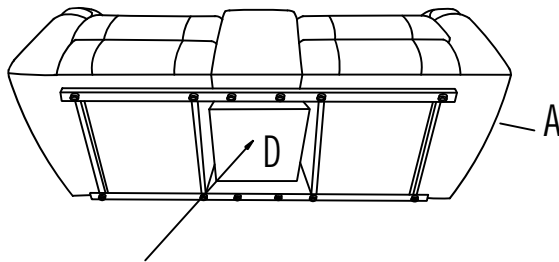

Take out Console back rest for assembly

STEP 2

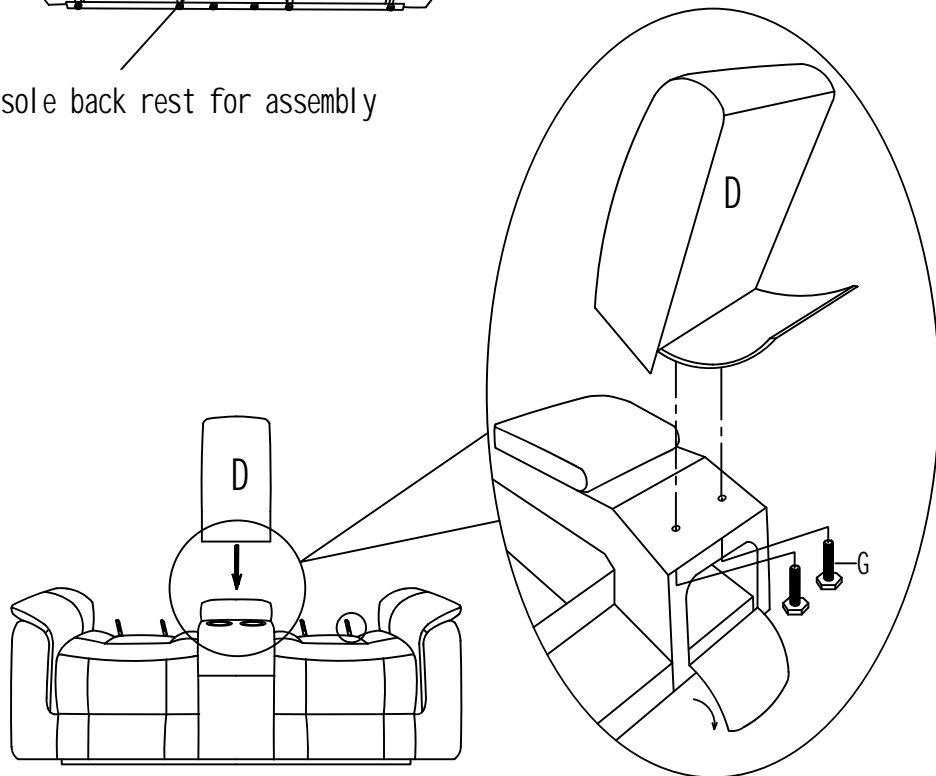

ASSEMBLING INSTRUCTIONS

DOUBLE RECLINING LOVE SEAT WITH CENTER CONSOLE

Step 3 # Align the femal metal bracket at the back onto the male metal bracket at the seat, insert back rest to the seat then push to the end and make sure it is fixed in position securely.

Step 4 # Align the metal bracket at the ear onto the male metal bracket at the back rest, push the ear down and make sune it is fixed in position securely.

STEP 3

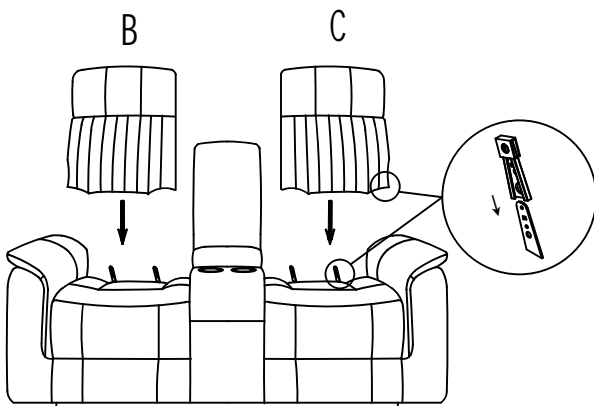

STEP 4

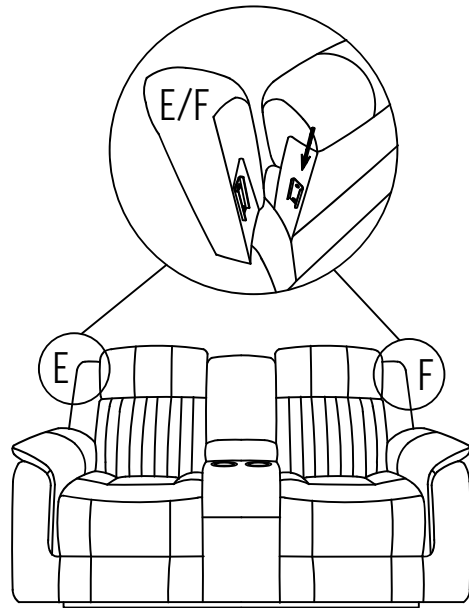

Step 5 # Completed

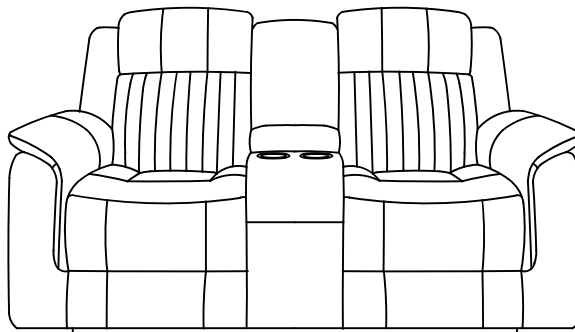



CARE INTRUCTION POLYESTER FURNITURE

In order to maintain the original appearance of your polyester furniture, please follow below simple care procedures.

°Avoid exposing polyester furniture directly to sunlight or heating and air conditioning outlets. Exposure to sunlight or heating and air conditioning outlets will fade/damage polyester furniture.

°Wipe gently with a damp soft cloth to remove dust , dirt and any grime build up.

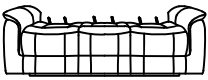
ASSEMBLY INSTRUCTION DOUBLE RECLINING SOFA

| NO. | PARTS LIST | QTY | DESCRIPTION |
|-----|---|-----|---------------|
| A |  | 1 | SEAT |
| B |  | 1 | LSF BACK REST |
| C |  | 1 | RSF BACK REST |

| NO. | HARDWARE LIST | QTY | DESCRIPTION |
|-----|---|-----|------------------|
| D |  | 1 | MIDDLE BACK REST |
| E |  | 1 | LSF EAR |
| F |  | 1 | RSF EAR |

Step 1 # Align the femal metal bracket at the back onto the male metal bracket at the seat, insert back rest to the seat then push to the end and make sure it is fixed in position securely.

Step 2 # Align the metal bracket at the ear onto the male metal bracket at the back rest, push the ear down and make sune it is fixed in position securely.

Step 1

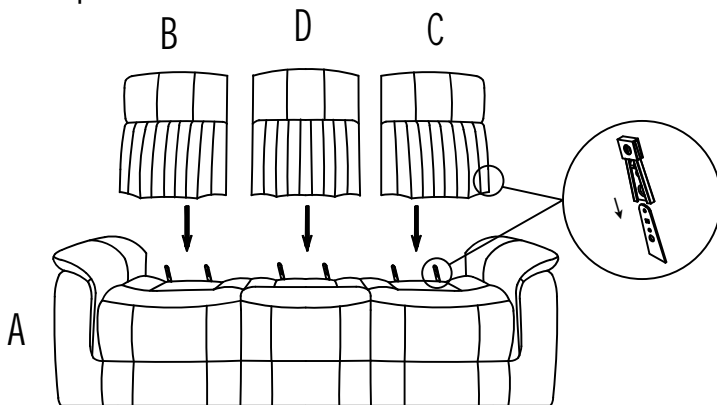

Step 2

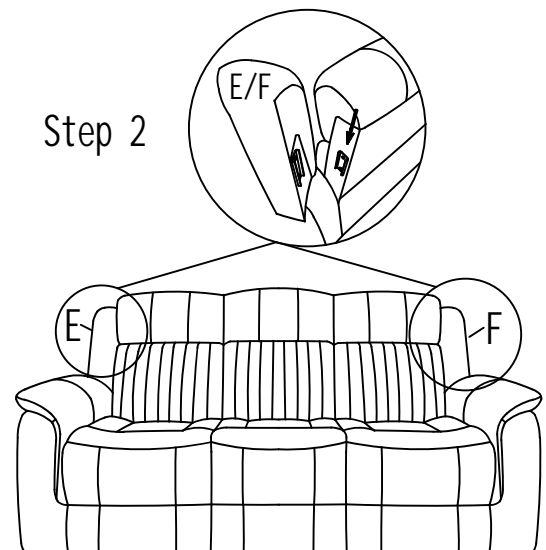

Step 3 # Completed

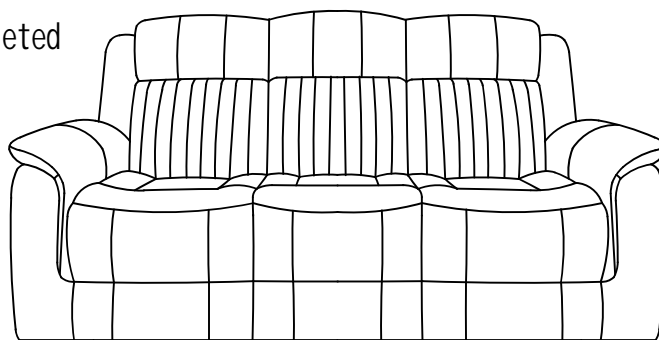

CARE INTRUCTION POLYESTER FURNITURE

In order to maintain the original appearance of your polyester furniture, please follow below simple care procedures.

°Avoid exposing polyester furniture directly to sunlight or heating and air conditioning outlets. Exposure to sunlight or heating and air conditioning outlets will fade/damage polyester furniture.

°Wipe gently with a damp soft cloth to remove dust, dirt and any grime build up.