

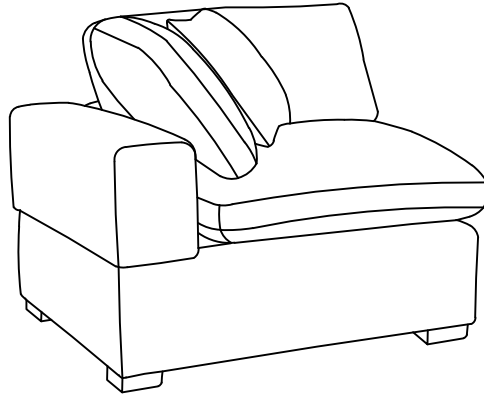

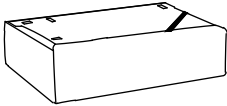

ASSEMBLY INSTRUCTION

ITEM NO: F10191-L & F10192-L & F10193-L

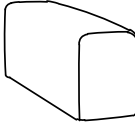

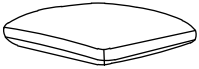
PARTS LIST

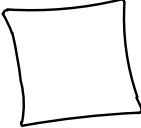
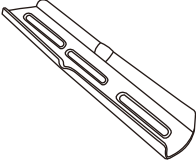
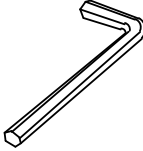
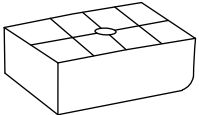
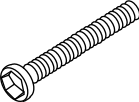
A  X1	B  X1	C  X1	D  X1	E  X1
F  X1	G  X1	H  X4	I  X1	J  X4
K  X4				

Packing list:

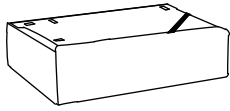

Ax1

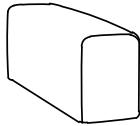

Bx1

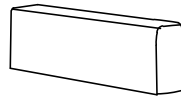

Cx1

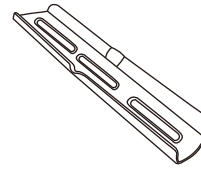

Hx4

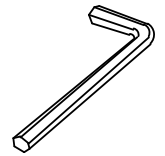

Ix1

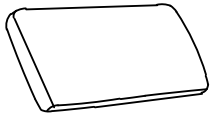

Dx1

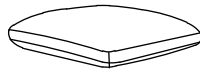

Ex1



Fx1

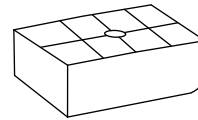

Jx4

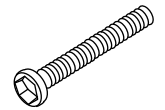

Kx4

Carton 1

Gx1

Hardware

STEP 1:

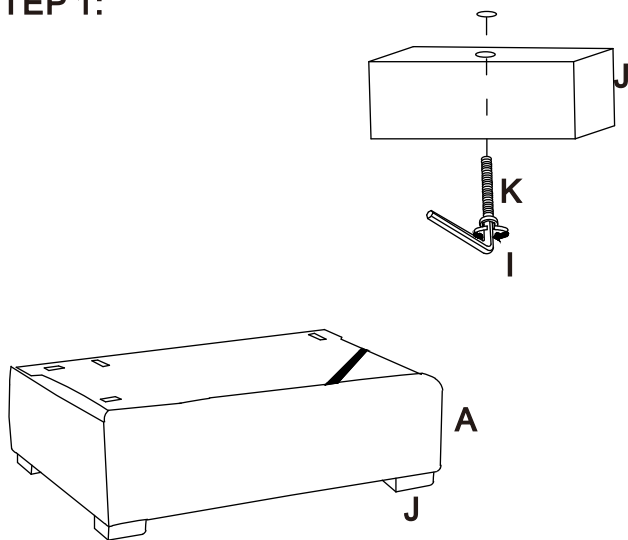

STEP 2:

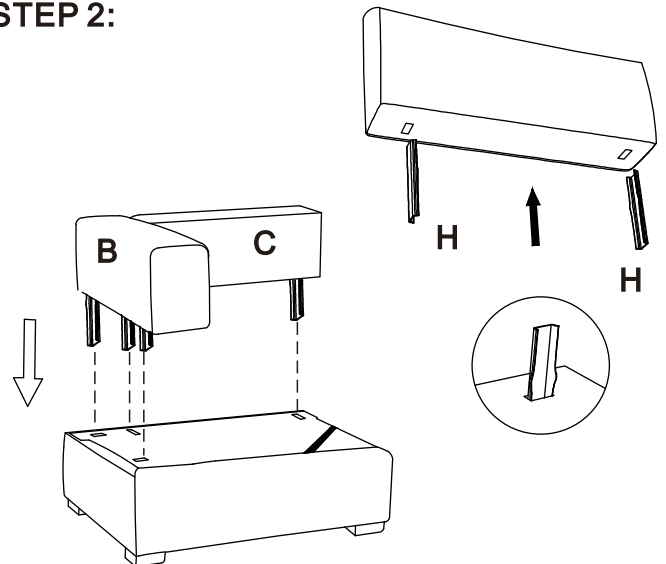

STEP 3:

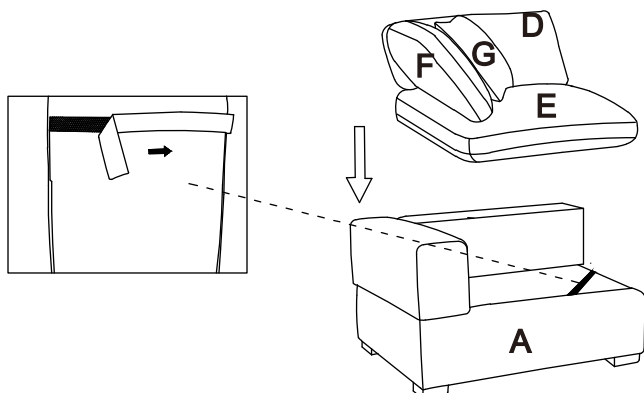

STEP 4:

