

















Assembly Instruction

Item No: HOCXH0159--Base

Part list

NO	Describeion	Drawing	QTY
A	Base pole		1pc
B	Base pole		1pc
C	Connector		1pc
D	Lower pole		1pc
E	Upper pole		1pc

Hardware list

NO	Drawing	Specification	QTY
F		Hanging part	1pc
G		Spring	1pc
H		Plastic foot	6 pcs
I		Screw M8X15MM	5 pcs
J		Screw M8X65MM	2 pcs
K		Screw M8X20MM	4 pcs
L		Washer	17 pcs
M		Bolt cap	11 pcs
N		Nut	6 pcs
O		Nut cap	6 pcs
P		Spanner	2 pcs

- ① Use bolt K, washer L, nut N, spanner P to attach base pole A & B, fasten to secure then attach bolt cap M and nut cap O.

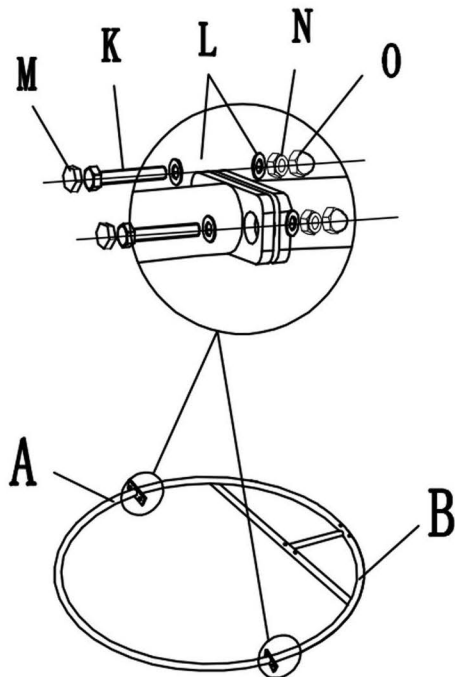

- ② Use bolt I, washer L, spanner P to attach connector C to base assembly, fasten to secure then attach bolt cap M.

